

**AT** MICROFICHE  
REFERENCE  
LIBRARY  
A project of Volunteers in Asia

Wind Pumping: A Handbook  
World Bank Technical Paper Number 101

By: Joop van Meel and Paul Smulders

Published by: IBRD  
1818 H Street, N.W.  
Washington, DC 20433

Available from: Publications Sales Unit  
The World Bank  
1818 H Street, N.W.  
Washington, DC 20433

Reproduced with permission.

Reproduction of this microfiche document in any form is subject to the same restrictions as those of the original document.

---

WORLD BANK TECHNICAL PAPER NUMBER 101

---

INDUSTRY AND ENERGY SERIES

---

# **Wind Pumping**

## **A Handbook**

**Joop van Meel and Paul Smulders**

**The World Bank  
Washington, D.C.**

Copyright © 1989  
The International Bank for Reconstruction  
and Development / THE WORLD BANK  
1818 H Street, N.W.  
Washington, D.C. 20433, U.S.A.

All rights reserved  
Manufactured in the United States of America  
First printing July 1989

Technical Papers are not formal publications of the World Bank, and are circulated to encourage discussion and comment and to communicate the results of the Bank's work quickly to the development community; citation and the use of these papers should take account of their provisional character. The findings, interpretations, and conclusions expressed in this paper are entirely those of the author(s) and should not be attributed in any manner to the World Bank, to its affiliated organizations, or to members of its Board of Executive Directors or the countries they represent. Any maps that accompany the text have been prepared solely for the convenience of readers; the designations and presentation of material in them do not imply the expression of any opinion whatsoever on the part of the World Bank, its affiliates, or its Board or member countries concerning the legal status of any country, territory, city, or area or of the authorities thereof or concerning the delimitation of its boundaries or its national affiliation.

Because of the informality and to present the results of research with the least possible delay, the typescript has not been prepared in accordance with the procedures appropriate to formal printed texts, and the World Bank accepts no responsibility for errors.

The material in this publication is copyrighted. Requests for permission to reproduce portions of it should be sent to Director, Publications Department, at the address shown in the copyright notice above. The World Bank encourages dissemination of its work and will normally give permission promptly and, when the reproduction is for noncommercial purposes, without asking a fee. Permission to photocopy portions for classroom use is not required, though notification of such use having been made will be appreciated.

The complete backlist of publications from the World Bank is shown in the annual *Index of Publications*, which contains an alphabetical title list and indexes of subjects, authors, and countries and regions; it is of value principally to libraries and institutional purchasers. The latest edition is available free of charge from the Publications Sales Unit, Department F, The World Bank, 1818 H Street, N.W., Washington, D.C. 20433, U.S.A., or from Publications, The World Bank, 66, avenue d'Iéna, 75116 Paris, France.

Joop van Meel and Paul Smulders, of DHV Consultants, Amersfoort, Netherlands, are consultants to the World Bank.

#### Library of Congress Cataloging-in-Publication Data

Van Meel, Joop, 1952-

Wind pumping : a handbook / Joop van Meel and Paul Smulders.  
p. cm. -- (World Bank technical paper. ISSN 0253-7494 ; no.  
101)

Bibliography: p.  
ISBN 0-8213-1235-9

I. Wind pumps--Handbooks, manuals, etc. I. Smulders, Paul, 1933-  
II. Title. III. Series.

TJ926.V34 1989

627'.52--dc20

89-9106  
CIP

## ABSTRACT

Interest in wind energy and in its application to the management of water supply has been growing. Many opportunities exist, especially in developing countries, for wind power to be used effectively and economically to pump water. This is particularly of interest in areas where other forms of energy are difficult or expensive to obtain. As a result, wind pumping in many instances represents the most effective and economic alternative.

This comprehensive handbook is meant to provide energy and water supply professionals and economists as well as field officers with an easily accessible source of information on wind pumping. It consolidates information acquired by institutions, professionals, and research centers in an easily extractable form. The first chapter is specifically dedicated to the question "Is wind pumping for you?". Chapter 2 then provides an overview of the characteristics of the technology. Chapter 3 discusses the techniques for sizing of wind pumps, while chapter 4 discusses the sizing of alternative small pumps. Chapter 5 provides guidelines for financial and economic assessment of wind pumping. Finally, chapter 6 provides particulars on installation, maintenance, and other logistical matters. Several annexes provide supporting details and examples.



WORLD BANK TECHNICAL PAPER NUMBER 101  
INDUSTRY AND ENERGY SERIES

P.P.R

# Wind Pumping

A Handbook

Joop van Meel and Paul Smulders

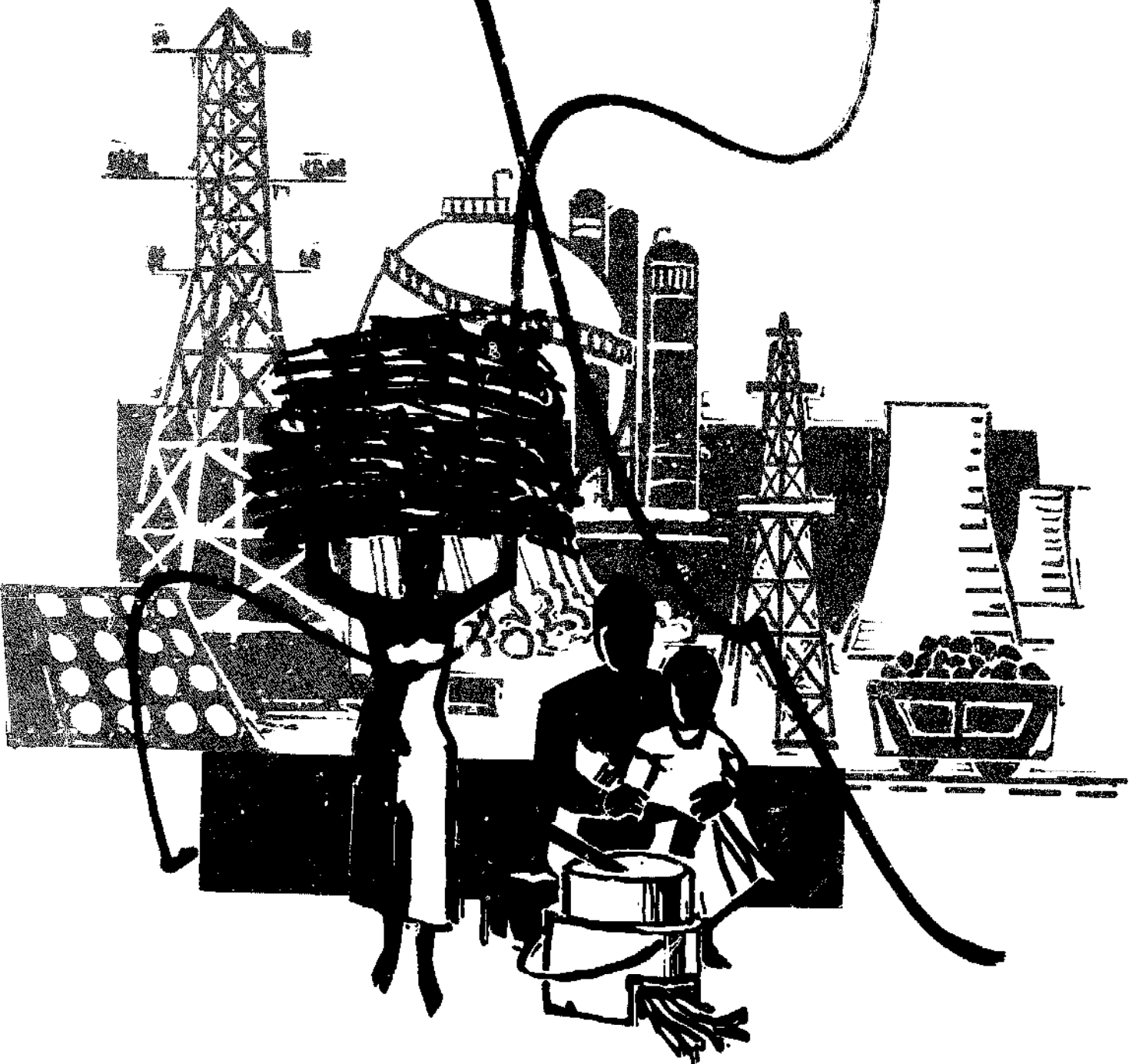

# CONTENTS

<b>Foreword</b> .....	<b>xv</b>
<b>Acknowledgements</b> .....	<b>xvii</b>
<b>Conversion of units</b> .....	<b>xviii</b>
<b>Introduction</b> .....	<b>xix</b>
<b>1. Is wind pumping for you?</b> .....	<b>1</b>
1.1 A brief history of the use of windmills .....	1
1.2 Water output and energy requirements .....	3
1.3 Evaluating a wind site .....	9
1.4 Typical water pumping applications .....	14
1.5 Viability of wind pumping .....	15
<b>2. Wind pump technology</b> .....	<b>21</b>
2.1 Types of wind pumps .....	25
2.2 Prime mover: mechanical windmill .....	27
2.2.1 Windmill components .....	27
2.2.2 Windmill characteristics .....	29
2.3 The piston pump .....	33
2.3.1 Description .....	33
2.3.2 Characteristics of a piston pump .....	34
2.4 Matching of windmill and piston pump .....	37
2.5 Performance of wind pump systems .....	41
2.6 Storage and distribution .....	43
2.6.1 Storage of water .....	43
2.6.2 Distribution .....	46
2.7 Which windmill should you choose? .....	47
<b>3. Wind pump sizing</b> .....	<b>48</b>
3.1 Assessing water requirements .....	51
3.1.1 Irrigation .....	51
3.1.2 Water requirements for rural water supply .....	53
3.2 Calculating the hydraulic power requirements .....	54
3.3 Determining the available wind power resources .....	56
3.4 Determining the design month .....	59
3.5 Sizing the wind pump system .....	61
3.5.1 Considerations in choosing the type of wind pump .....	61
3.5.2 High output versus high output availability .....	63
3.6 Preparing the final specifications .....	71

<b>4.</b>	<b>Sizing of alternative small water pumping systems</b>	<b>75</b>
4.1	Determining monthly hydraulic power requirements	77
4.2	Determining the available power resources	77
4.3	Determining the design month	77
4.4	Sizing the power source and pump	79
4.4.1	Wind pumps	79
4.4.2	Solar Pumps	79
4.4.3	Engine-driven pumps	83
4.4.4	Animal traction and hand pumps	84
<b>5.</b>	<b>Financial Assessment</b>	<b>87</b>
5.1	Economic and financial analysis	87
5.2	Procedure for a simplified cost comparison of small-scale water pumping techniques in a specific situation	91
5.3	General data on costs	99
5.3.1	Data on wind pump costs	99
5.3.2	Costs of other pumping systems	105
5.4	General comparison of unit water costs for different small-scale water pumping techniques	106
<b>6.</b>	<b>Logistics and supporting activities</b>	<b>113</b>
6.1	Procurement	113
6.1.1	Local manufacture - an interesting alternative	115
6.2	Installation, operation and maintenance	116
6.2.1	Installation	116
6.2.2	Operation and maintenance	119
6.3	Monitoring and evaluation	120
6.3.1	Aspects of monitoring and evaluation	120
6.3.2	Monitoring and testing	123
6.3.3	Simple cumulative measurements	125
6.4	Manpower and training requirements for installation of large numbers of wind pumps	126
	<b>Appendix A. Wind resources</b>	<b>131</b>
A.1	Wind on a worldwide scale	132
A.2	Wind data requirements	138
A.3	Wind in graphs and numbers	143
	<b>Appendix B. Details of the sizing methodology</b>	<b>151</b>
B.1	Equations used for sizing method of Chapter 3	152
B.2	Complete sizing and output prediction methodology	153

B.3	Output prediction model .....	155
B.4	Storage tank sizing .....	159
<b>Appendix C. Simple method of calculating costs of water pumped by a wind pump, engine-driven pump and solar pump .....</b>		<b>161</b>
C.1	Costs of water pumped by a wind pump .....	162
C.2	Costs of water pumped by an engine-driven pump .....	164
C.3	Costs of water pumped by a solar pump .....	167
C.4	The annuity factor .....	169
<b>Appendix D. Examples .....</b>		<b>171</b>
<b>Example D.1: Irrigation in the dry zone of Sri Lanka .....</b>		<b>172</b>
<b>Example D.2: Water Supply to the village of Sao Filipe, Cape Verde .....</b>		<b>183</b>
<b>Appendix E. Blank Format Sheets .....</b>		<b>195</b>
<b>Appendix F. Example tender documents for the procurement of wind pumps .....</b>		<b>205</b>
F.1	Instructions to tenderers .....	207
F.2	Specification .....	207
F.3	Questionnaire for tenderers .....	212
F.4	Price and delivery .....	214
<b>Appendix G. Glossary, list of symbols, and conversion of units .....</b>		<b>217</b>
G.1	Glossary .....	218
G.2	List of symbols .....	223
G.3	Conversion of units .....	225
<b>References .....</b>		<b>227</b>
<b>Annex: Testing and monitoring of wind pump systems in field conditions .....</b>		<b>233</b>
1.	<b>Introduction .....</b>	<b>234</b>
1.1	<b>The "Handbook for comparative evaluation of technical and economic performance of water pumping systems" .....</b>	<b>234</b>
1.2	<b>Overview of the test procedures .....</b>	<b>235</b>
2.	<b>Personnel and equipment requirements .....</b>	<b>236</b>
2.1	<b>Personnel qualifications .....</b>	<b>236</b>
2.2	<b>Measurement equipment required .....</b>	<b>237</b>

<b>3.</b>	<b>Data collection at the start of the tests</b> .....	<b>240</b>
3.1	General information .....	240
3.2	Persons involved .....	242
3.3	Water source and well construction .....	242
3.4	Summary of operating experience .....	243
3.5	System description wind pumps .....	243
3.6	Description of the site .....	246
<b>4.</b>	<b>Short-Term Tests</b> .....	<b>247</b>
4.1	Objectives .....	247
4.2	Test protocol .....	247
4.3	Data reduction .....	252
<b>5.</b>	<b>Long-Term Tests</b> .....	<b>256</b>
5.1	The "system" during Long-Term Tests .....	256
5.2	Measurements and data collection during Long-Term Tests .....	256
5.3	Data reduction of Long-Term Tests .....	263
<b>6.</b>	<b>Total effective head</b> .....	<b>270</b>
	<b>References</b> .....	<b>272</b>

## List of figures

1.1	Technical and effective water output	3
1.2a	Schematic layout of a village water supply system showing the five major components	4
1.2b	Schematic layout of a small irrigation system showing the six major components	4
1.3a	Energy losses in a water pumping system	6
1.3b	Composition of total pumping head	6
1.4	Worldwide wind energy resource distribution estimates	following 274
1.5	Examples of monthly and hourly variations of wind speed, Khartoum	8
1.6	Chart to estimate the output of a water pumping windmill	10
2.1	Schematic layout of wind pumping system for water supply for domestic use and livestock	22
2.2	Photographs of mechanical wind pumps	23
2.3	Types of wind pumps classified according to type of transmission	24
2.4	Components of mechanical windmills	26
2.5	Dimensionless torque-speed and power-speed characteristics of wind rotors of mechanical wind pumps	30
2.6	Piston pumps used in combination with windmills	32
2.7	Torque of a piston pump versus time	34
2.8	Rough indication of the range of application of different pump types in combination with wind machines	37
2.9	Matching of windmill and piston pumps	38
2.10	Storage tanks: principles of construction	44
3.1	Steps to be taken for evaluation and design of pumping installations	49
3.2a	Soil moisture quantities	51
3.2b	Rate of crop growth as a function of soil moisture content	52
3.3	Nomogram to determine the rotor size of a wind pump	64
3.4	Nomogram to size the pump of a wind pump system	66
3.5	Nomogram to choose stroke and diameter of piston pump	68
3.6	Head loss in smooth pipes of different internal diameters	71
4.1	Nomogram to determine the average hydraulic power requirement from pumping requirement and total head	76
4.2	Nomograms for approximate sizing of wind and solar pumps	78
4.3	Nomogram for approximate sizing of engine-driven pumps	82
4.4	Graphs for approximate sizing of animal traction and hand pumps	84
5.1	Prices (ex factory) of wind pumps	99
5.2	Trends in specific mass (kg per m <sup>2</sup> rotor area) of classical multiblade and modern design wind pumps	100
5.3a	Comparison of unit water pumping costs of wind, solar, and engine-driven pumps (past/present)	108
5.3b	Comparison of unit water pumping costs of wind, solar, and engine-driven pumps (present/future)	109

6.1	Typical wind pump system layouts	115
6.2	Typical methods for erection of wind pumps	117

**Figures in appendices**

A.1	Schematic picture of the general circulation of air around the globe	134
A.2	Simple schematic picture of sea-breeze circulation	136
A.3	Schematic illustration of mountain (A) and valley (B) wind	136
A.4	Information relevant to the utilization of wind energy for water pumping	139
A.5	Zone of disturbed flow over a small building	141
A.6	Siting of wind pumping systems in complex terrain	142
A.7	Average wind speed at the hub height of rotor	146
A.8	The Weibull distribution	147
A.9	The cumulative velocity distribution of the month June 1975, measured in Praia (Cape Verde)	149
B.1	Energy production coefficient as a function of design wind speed over average wind speed	154
B.2	Output availability of 10% of average output as a function design wind speed over average wind speed	154
B.3	Calculation of total output of a wind machine from the wind speed frequency distribution and the output curve	156
B.4	Output performance of a windmill coupled to a piston pump Output behaviour and average output curves	156
B.5	Output curves used for the computations	158
B.6	The relationship between the required storage tank capacity (in days) and the wind pump exploitation factor $f_w$	160
D.1	Cropping pattern of a typical small farm in the dry zone of Sri Lanka	174
D.2	Layout of Achada Sao Filipe water supply system	183
D.3	Layout of Achada Sao Filipe water pumping system	184
F.1	Examples of layout of wind pumping system	215

**Figures in annex**

2.1	Installation of flow meters	238
4.1	Example of water output curve	253
4.2	Example of rotor rotational speed curve	253
4.3	Example of overall wind pump performance factor curve	254
5.1	Example of head measurements	259
6.1	Equivalent head for horizontal transport as a function of the distance L	270

## List of tables

1.1	Hydraulic power and energy output of a 5-meter diameter wind pump for different average wind speeds .....	13
1.2	Preliminary assessment of using wind pumps .....	16
2.1	Types of pumps suitable for application in combination with wind machines .....	36
2.2	Representative values of design and performance characteristics for wind pump systems .....	40
2.3	Suitability of major irrigation methods for use with wind pumps .....	47
3.1	Specification of example site .....	50
3.2	Typical net irrigation water requirements for Bangladesh and Thailand .....	52
3.3	Typical daily water requirements for livestock .....	53
3.4	Format sheet for assessment of hydraulic power requirements .....	55
3.5	Format sheet for assessment of wind power resources .....	56
3.6	Format sheet for identification of design month .....	58
3.7	Format sheet for wind pump system sizing .....	60
3.8	Format sheet for specification of wind pump performance .....	72
4.1	State of the art for motor/pump subsystem of solar pumps .....	80
5.1a	Format sheet to calculate the unit water cost of a small-scale pumping system. Completed for the example wind pump system of Chapter 3 .....	90
5.1b	Format sheet to calculate the unit water cost of a small-scale pumping system. Completed for the example solar pump system .....	92
5.1c	Format sheet to calculate the unit water cost of a small-scale pumping system. Completed for the example diesel pump system .....	94
5.2	Wind pump costs per unit weight .....	101
5.3	Approximative cost components of classical wind pumps in percentages .....	101
5.4	Approximative cost aspects of storage tanks .....	103
5.5	General (approximative) cost aspect of small-scale pumping systems .....	104
6.1	Format sheet for recording wind pump performance .....	124

## Tables in appendices

A.1	Conversion of units of wind velocity .....	143
A.2	Beaufort scale, used for classifying wind speeds .....	144
A.3	The density of dry air at different altitudes under standard conditions .....	145
A.4	Roughness classification .....	145
B.1	Values of start and stop wind speeds related to design wind speed for various types of wind pumps .....	158
C.1	Annuity factor as a function of interest rate and lifetime .....	169



D.1	Irrigation requirements and cultivated area of small farm in dry zone of Sri Lanka	174
D.2-D.8	Completed format sheets for dry zone of Sri Lanka	178-81
D.9	Wind speed data of Praia airport	186
D.10-D.16	Completed format sheets for Achada, Sao Filipe, Cape Verde	190-93

**Tables in annex**

1	Personnel requirements	236
3.1	Data sheet. General information on pumping system	240
3.2	Data sheet. Persons involved in daily care for the system	241
3.3	Data sheet. Water source	242
3.4	Data sheet. System description wind pump	244
3.5	Data sheet. Summary of wind data	246
4.1	Data sheet. Measurements and calculations Short-Term Tests	250
5.1	Data sheet. Measurements and calculations Long-Term Tests	257
5.2	Data sheet. Chronological survey of all relevant events	261
5.3	Data sheet. Summary of information of wind pump system	267

## Foreword

Many rural areas of the world have an acute need for reliable inexpensive systems for pumping water for domestic use, for livestock, and for small-scale irrigation. The wind pump, used for centuries to lift water, but largely abandoned after the introduction of engine-driven pumps (generally fuelled by diesel or kerosene) and electric pumps, is now being reconsidered as one of several alternative technologies that can be used to assure that rural water pumping needs are met.

The classic multibladed windmill that was a familiar sight in the Great Plains of the US until the 1940s is still being manufactured today. However, engineers have recently begun to make improvements to the design of these pumps, and adapt them for use in developing countries.

Since the oil crisis in 1973 that led to a substantial increase in the price of oil-based fuels, there has been great interest in renewable energy sources such as wind and solar. In the last ten years, considerable effort has been spent on the development and promotion of wind pumps. A few thousand "modern" wind pumps have been installed in pilot projects in developing countries. Some important lessons have been learned from these projects. First, it has been proven in a number of cases that, where the right conditions exist, the use of wind pumps is economically feasible. Second, the feasibility of manufacturing the pumps locally, without the use of expensive imported parts, has been demonstrated. Third, the general conclusion from the studies is that sufficient scope exists for further development of wind pumping. And it is expected that as more is learned about making windmills, and more are made, the costs of wind pumping will fall.

The publication of this handbook came about as the result of an international workshop on wind pumping held in October 1984 in Amersfoort, Netherlands<sup>1</sup>. Following up on proposals made at the workshop, the World Bank and the United Nations Development Programme (UNDP) initiated a Global Wind Pump Evaluation Programme (GWEP). The primary objective of the GWEP is "to generate and disseminate the information and analyses which water users, national policymakers and national and international financing agencies need to assess the technical and economic merits of wind pumping".

In 1986, the World Bank and UNDP assigned to Consultancy Services Wind Energy Developing Countries (CWD) the task of realizing the initial phase of the GWEP. This initial project is supported by contributions from the Government of the Netherlands, the European Community, the OPEC Fund for International Development, the British Overseas Development Agency, the United States Agency for International Development, and the UNDP Energy Account. Donor contributions were provided through cost-sharing arrangements through the UNDP Energy Account. The World Bank serves as the program's executing agency and provides overall coordination and technical guidance.

---

<sup>1</sup> The workshop was sponsored by the World Bank, UNDP and the Netherlands Government and was organized by Consultancy Services Wind Energy Developing Countries (CWD).

Besides preparing this handbook, CWD was asked to prepare studies on:

- (a) the current position and prospects for wind pumping in a number of countries and
- (b) wind pump testing and monitoring procedures.

An annex has been added to the handbook entitled "Testing and monitoring of wind pump systems in field conditions". This is Part Two of a report by Peter Oostendorp and Dick Veldkamp entitled "Recommended practices for testing of water pumping windmills".

The handbook is intended as an equivalent of the excellent "Solar Water Pumping Handbook" by Kenna and Gillet, published in 1985 by Intermediate Technology Publications<sup>2</sup>, and uses the same general layout. Where appropriate, the texts of the Solar Handbook are quoted and referred to.

However, the authors of this handbook could not draw on the test results of a worldwide monitoring program, as was the case when the Solar Water Pumping Handbook, which more or less finalized the preceding UNDP/World Bank project "Testing and Demonstration of Small Scale Solar Pumping Systems", was written. They have had to rely on the experience gained by CWD in the field and that obtained from personal contacts and extensive reading.

They anticipate that the handbook will need to be updated once the results of field measurements and experience become available. Suggestions and criticisms from readers are welcomed, and should be addressed to:

**CWD, Consultancy Services Wind Energy Developing Countries  
PO BOX 85  
3800 AB AMERSFOORT  
The Netherlands**

---

<sup>2</sup> Jeff Kenna and Bill Gillett, *Solar Water Pumping, a Handbook*, the World Bank, Washington, US, and Sir William Halcrow and Partners, UK, pub. Intermediate Technology Publications, 1985.

## Acknowledgements

This publication has been prepared by Paul Smulders, Project Leader, Wind Energy Group, Technical University Eindhoven, and Joop van Meel, former Research Fellow, Wind Energy Group, Technical University Eindhoven. (Mr. van Meel is currently affiliated with Haskoning Consulting Engineers).

The Annex to this publication was a joint production by various authors, as explained in the Annex. Peter Oostendorp, Project Leader, Wind Energy Group, Technical University, Twente, was the editor.

Overall project management resided with DHV Consultants. DHV Consultants, the Technical University, Eindhoven and the Technical University, Twente jointly comprise CWD.

The authors would like to thank Riet Bedet-Nieuwenhuizen (CWD) for her patient struggle with the word processor. Further thanks are due respectively to Walter Dekkers, Adriaan Kragten and Paul Kompier (CWD) for the drawings and to Irene de Jong (CWD) for her assistance in preparation of the manuscript.

The authors also express their particular gratitude to Rene Moreno and other staff members of the World Bank, and to Krishna Prasad (Technical University, Eindhoven) for their valuable and constructive comments and suggestions.

Monique Huisman and Jan Hoevenaars (Institute for Land Reclamation and Irrigation, Wageningen) assisted with a review of an earlier draft.

Finally, the authors acknowledge the work of their CWD colleagues without whose dedicated and professional contribution to wind pumping this handbook could never have been written.

## Conversion of units

### Power

	W	kWh/day	MJ/day	m <sup>4</sup> /day*
W	1	0.024	0.0864	8.816
1 kWh/day	41.67	1	3.6	367.3
1 MJ/day	11.57	0.2778	1	102.04
1 m <sup>4</sup> /day*	0.1134	0.002722	0.0098	1

\* Conversion based on 9.80 m/s<sup>2</sup>, an average value between latitudes from -50° to + 50°.

### Pumping rate

	l/s	m <sup>3</sup> /hr	m <sup>3</sup> /day
l/s	1	3.6	86.4
m <sup>3</sup> /hr	0.2778	1	24
m <sup>3</sup> /day	0.01157	0.4167	1

1 US gallon = 3.785 l

1 Imp. gallon = 4.546 l

### Wind speed

	m/s	km/hr	mph	knots
1 m/s	1.000	3.600	2.237	1.944
1 km/hr	0.278	1.000	0.622	0.540
1 mph	0.447	1.609	1.000	0.869
1 knot	0.514	1.852	1.151	1.000

# INTRODUCTION

## Purpose of the Handbook

This handbook has been prepared to give an insight into the merits of using wind energy for small-scale water pumping and to enable a comparison between the use of wind pumps and use of the small-scale technologies, specifically solar pumps, engine-driven pumps, animal traction and hand pumps.

The handbook is intended as a reference source for a diverse group of people who are involved in lifting and distributing water in rural areas. It is written for policymakers, who must consider what use can be made of wind pumps in a certain area, as well as for people involved directly in water supply and irrigation (farmers, engineers, etc.), who must decide whether to use wind pumps in specific cases.

The methods of assessing the viability of wind pumping are more complex than for other small-scale technologies. One of the problems is in determining how much wind energy is available at a given location to run a pump and supply the quantity of water needed. Wind potential varies considerably, not only from region to region, but even over very short distances. Accurate wind data are needed to determine the available wind power. Once wind power has been determined, other steps have to be taken involving other calculations. The authors advise consulting a local expert if accurate wind data is not readily available.

Though the handbook contains a large amount of technical information, the general reader should still find it useful, at least in making a first decision on whether to consider using a wind pump.

## Organization

The handbook is divided into six sections. Chapter 1 is an introduction to wind pumping. It looks at the wind as an energy resource, describes typical water pumping applications, and discusses the viability of wind pumping under the various circumstances the reader might encounter. Chapter 2 is devoted to wind pump technology. It describes the various types of wind pumps, gives the components and characteristics of the mechanical windmill and the piston pump, considers the important question of how to match windmill and piston pump, and discusses water storage and distribution. Chapter 3 describes the steps involved in sizing a wind pump for a particular situation and location. It also gives technical specifications for system

configuration and performance. Chapter 4 gives sizing procedures for solar pumps, engine-driven pumps, animal-traction and hand pumps, so that the reader can later compare the costs and benefits of using one of these pumps with the costs and benefits of using a wind pump using the financial analysis described in Chapter 5. Chapter 6 will be mainly of interest to managers of large-scale projects. It discusses procurement, installation, operation and maintenance, monitoring and testing of wind pumps as well as the need for training in wind pump use and maintenance.

Further technical details, sample procurement documents, etc., as well as a glossary of terms used, are provided in the appendices. These are followed by a list of the references used by the authors in writing this book. An annex entitled "Testing and Monitoring of Wind Pump Systems in Field Conditions" edited by Peter Oostendorp is attached after the references and can be read separately.

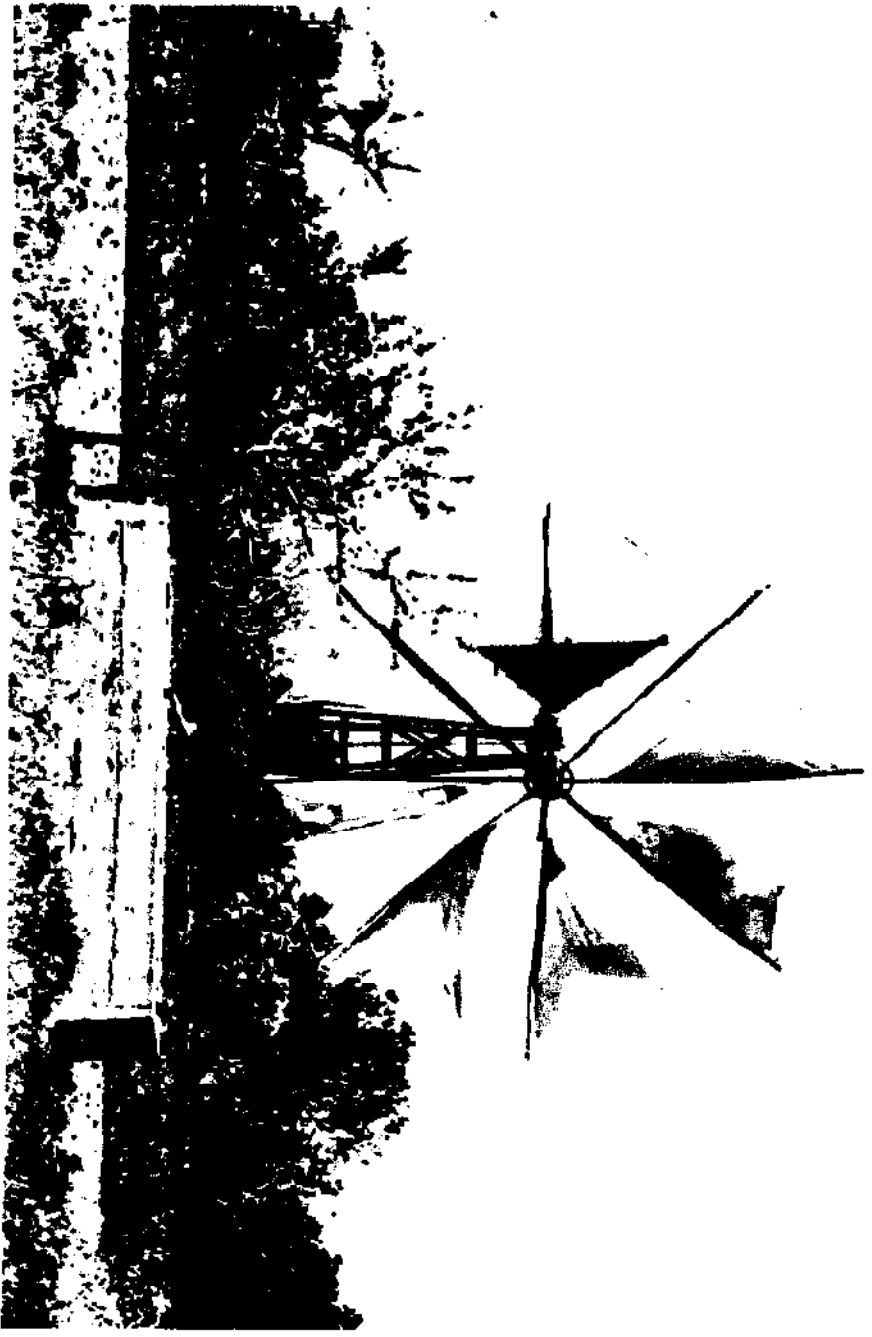

*The famous wind pumps of the Lassithi plain (25 km<sup>2</sup>) on the Greek island of Crete. In their heyday around 1958 about 20,000 windmills were in operation.*



## Chapter 1

# IS WIND PUMPING FOR YOU?

This chapter describes the information needed and the calculations that must be made in order to decide whether wind pumping might be a viable option at a given site. Section 1.1 gives a brief history of windmills, and suggests that more will be used in the future as prices fall. Section 1.2 discusses water output and energy requirements. Section 1.3 describes factors involved in evaluating a wind site, and gives a rule of thumb for calculating the wind power needed to pump water. Section 1.4 describes typical water pumping applications for rural areas, the types of pumping systems that are appropriate for each, and gives typical costs of providing water for each application. Section 1.5 gives simple rules that can be followed in making a preliminary assessment of the viability of using wind pumps.

After reading Chapter 1, the reader can decide whether or not it is worthwhile, in the light of his requirements, to go through the detailed analysis given in subsequent chapters.

### 1.1. A brief history of the use of windmills

Water is a basic need for mankind, be it for domestic purposes, for livestock or for irrigation. In many rural areas of the world, water has to be lifted from rivers and wells using some kind of pumping system.

For several centuries in Europe, and during the 19th century in the United States, wind energy was widely used to pump water. Historically, wind energy was first used to propel boats through rivers and across oceans. The idea of the sail, which captures the wind, was then adapted for use on land, and windmills were built to mill flour. In Europe, the earliest record of horizontal axis windmills goes back to the 12th century in England. The technology spread all over Europe in subsequent centuries.

In Holland, from the 15th century onwards, windmills were used to drain swamps and lakes and reclaim new lands. Wind energy was used to lift water and pump it out of an area. By reclaiming low-lying land for agriculture, windmills contributed greatly to Holland's economic development. By the beginning of the 19th century there were about 10,000 large windmills with rotor blades up to 28 meters in diameter in operation in that country. In the rest of Europe there were several tens of thousands more, used for a number of purposes.

Use of windmills declined in Europe following the introduction of steam engines. But as European mills began to disappear, a different type of windmill entered into wide use on the Great Plains of the U.S. The multibladed "American" wind pump was developed, consisting of rotor blades to catch the wind, a transmission to transfer the energy to a piston pump, and the pump itself, which raised the water. Millions were used to pump water for domestic use and for livestock. They were essential to the rapid development on the plains. Many of these windmills, referred to in the text as the "classic" multibladed windmill, fell into disuse when they were replaced by oil-powered or electric pumps.

Though the use of windmills in the industrialized countries has now greatly declined, it has not stopped. The classic multibladed windmill is still being manufactured and probably about a million are in use today, particularly in the U.S., Argentina, Australia and South Africa. They provide water for households, for livestock, and sometimes for irrigation.

Besides the multibladed windmill, other types have been developed but their application has been restricted to the local situation for which they were made. The white-sailed mills used for irrigation on the Lassithi plain on the Greek island of Crete are well known. In Holland thousands of small four-bladed all-steel windmills (driving a centrifugal pump) are still in use to drain the polders. In Thailand very simple mills of wooden construction with triangular bamboo "blades" are used to pump sea water into salt ponds.

Between 1920 and 1940 the classic multibladed windmill was introduced in quite large numbers in many developing countries, including Morocco, Tunisia, Somalia, Mozambique and Mali. However, most of them fell into disuse in the 1950s as petroleum-based fuels became available in large quantities and at very low prices.

With the rise of oil prices in the early 1970s, the interest in wind pumps revived. However, the introduction of the existing classic multibladed windmills in the developing countries has been hampered due to the cost of importing them (or importing the materials needed to make them) and to maintenance requirements.

Since 1974 a number of organisations have been working along new lines of design and construction to develop wind pumps that lift water at lower costs than the traditional multiblades. In addition much attention has been paid to the possibilities of local manufacture by avoiding specialized parts in the design that require complicated machinery for their manufacture.

These efforts are starting to bear fruit. Currently a few thousand of these new mills are operating all over the world, in places like Kenya, Sri Lanka, Cape Verde, Pakistan, Mozambique, Tanzania, Sudan, Botswana, Tunisia, Brazil, China). They are being used experimentally in pilot projects, and also in dissemination programs.

As new and more efficient windmill designs are developed, and as production costs are lowered through the use of materials obtained locally, the costs of pumping water with wind pumps should go down. It is expected that they will reduce by a factor of 2 to 4 in the foreseeable future. The trend in this direction has already begun.

## 1.2. Water output and energy requirements

It may seem that all that needs to be done when one decides to purchase and install a water pumping system is to calculate how much water is needed and then find a pumping system big enough to supply that amount of water, at a price one can afford.

In the case of a wind pump, there are other things to consider. The wind is highly variable. The user cannot control when it will start and stop or how strongly it will blow. A strong wind may provide enough water to overflow a storage tank, or to spill water on the ground if there is no tank. A weak wind might not provide enough water for the user's needs. Also, the user's needs may vary depending on what the water will mainly be used for.

The technical output of a wind pump of a given size can be calculated, if the available wind resources are known. The effective output depends on the needs of the user. For instance, a farmer using water for irrigation will not need water during the harvest, even though the wind may be strong enough for the windmill to pump water.

The relationship between technical and effective water output is shown in Figure 1.1.

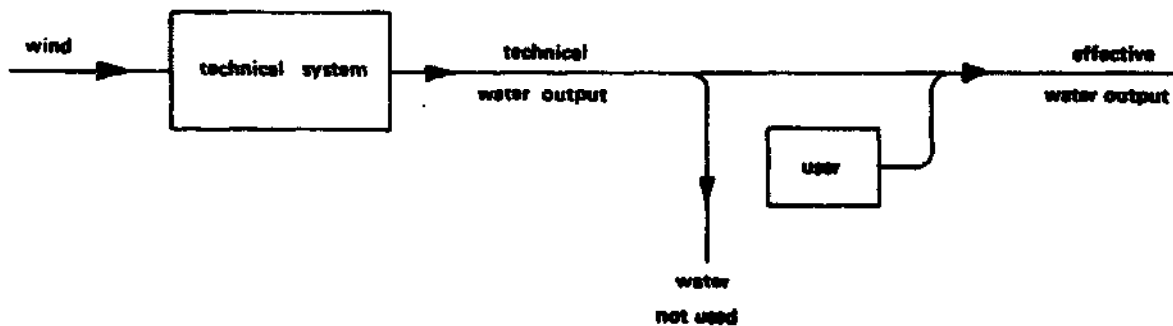

Figure 1.1. Technical and effective water output.

The effective output of a wind pump will depend strongly on local conditions and the kind of application the pump is used for. Figure 1.2 shows two typical layouts of a wind pumping system. Besides the wind pump itself, the system includes a well or other water source, suction and delivery lines, a storage tank, a distribution system, and, in the case of irrigation, a field application system.

For wind pump systems, one must calculate fairly exactly the amount of water needed. The investment cost for a wind pump system is roughly proportional to its rotor area. The total energy production of a wind pump (amount of water pumped over a given height) is directly proportional to the rotor area. Therefore, the amount of water needed influences the size of rotor one must select, which influences the cost of the windmill. The cost of water storage must be included in the cost of the system, since the wind pump, unlike engine-driven pumps, electric pumps, or even hand pumps, cannot be counted on to provide water on demand.

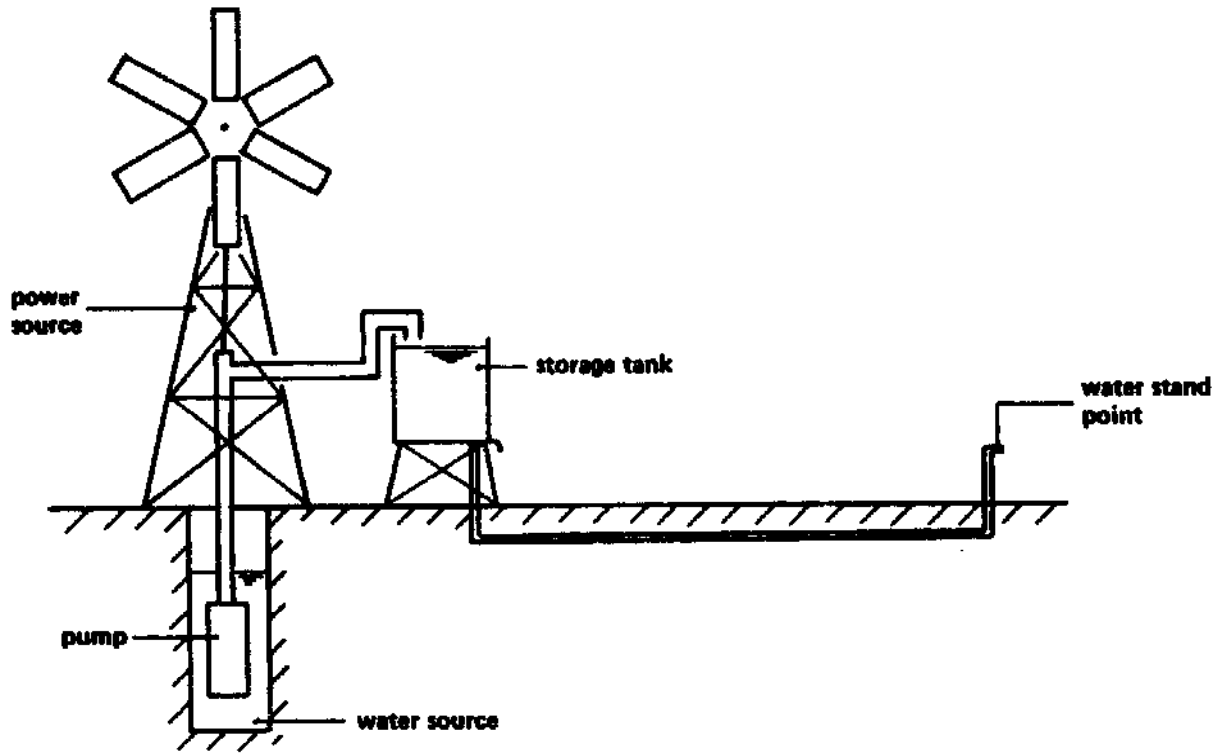

Figure 1.2.a. Schematic layout of a village water supply system showing the five major components.

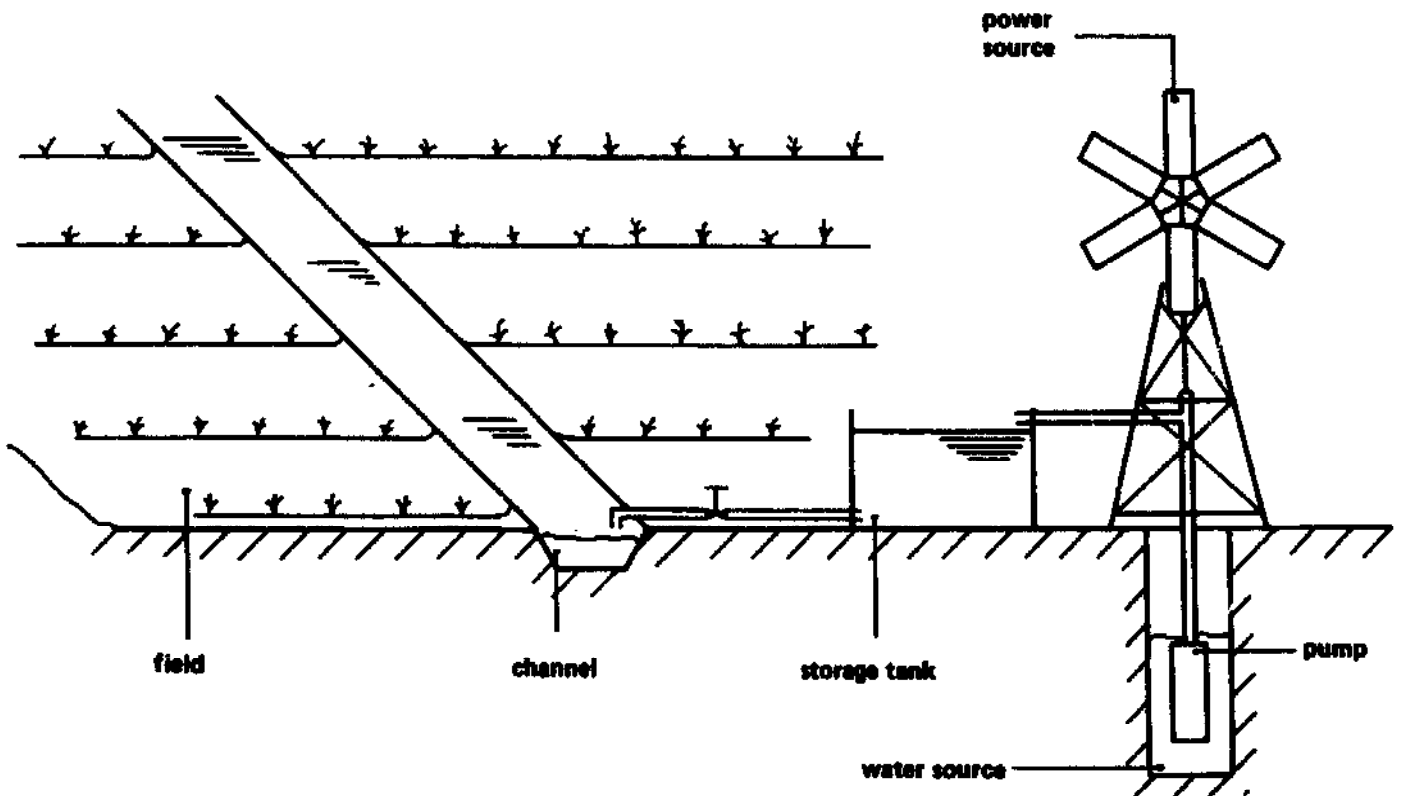

Figure 1.2.b. Schematic layout of a small scale irrigation system showing the six major components.

Once the effective output, the actual amount of water the user needs, has been determined, one must then calculate the amount of energy needed to pump this volume of water. The net amount of hydraulic (pumping) energy required to lift a volume of water over a total head  $H$  is given by:

$$E = \rho g H Q \quad (\text{Joules}) \quad (1.1a)$$

where:

- $E$  = required (hydraulic) energy in Joules
- $\rho$  = density of water ( $1000 \text{ kg/m}^3$ )
- $g$  = gravitational acceleration ( $9.8 \text{ m/s}^2$ )
- $H$  = total head in meters
- $Q$  = volume of water in  $\text{m}^3$

Doubling the water volume doubles the energy requirement. Increasing the head by a factor of two likewise doubles the energy requirement.

In this publication we will very often use the kilowatt hour (kWh) as the unit for energy. We prefer to use it instead of the megajoule (MJ) for reasons of simplicity and ease of calculations. If we specifically consider hydraulic energy, we will use the subscript  $h$ :  $\text{kWh}_h$ <sup>1</sup>.

Instead of the  $\text{kWh}_h$  we can also introduce the hydraulic energy equivalent, being the product of the volume of water  $Q$  times the head  $H$  ( $Q \times H$ ). From (1.1a) it follows that:

1  $\text{kWh}_h$  is equivalent to  $367 \text{ m}^4$

This means:

Lifting  $367 \text{ m}^3$  over 1 m head, or  $36.7 \text{ m}^3$  over 10 m head or  $3.67 \text{ m}^3$  over 100 m head are in terms of hydraulic energy all equivalent and equal to 1  $\text{kWh}_h$ .

In reality more energy than indicated above is needed to lift water. Figure 1.3a illustrates the energy flows in a pumping system. The input energy for the pump system undergoes several conversions before it is made available as useful hydraulic energy. Each conversion has an associated loss of energy which means that the input energy requirements for pumping are generally far greater than the useful hydraulic energy output. For example, if the power source (prime mover) is a diesel engine, the input energy will be in the form of diesel fuel: the energy content of 1 liter of diesel fuel is approximately equivalent to 38 MJ (10.5 kWh). If the fuel is converted to mechanical energy with an efficiency of 15% then 1 liter of fuel will produce  $38 \times 0.15 = 5.7 \text{ MJ}$  (1.6 kWh) of mechanical energy. A pump may then convert the mechanical energy to hydraulic energy with an efficiency of say 60%, giving a useful hydraulic energy of  $5.7 \times 0.6 = 3.42 \text{ MJ}$  (0.95  $\text{kWh}_h$ ) for 1 liter of fuel. In a similar way losses occur when solar radiation, muscle power or wind energy is converted to hydraulic energy.

---

<sup>1</sup> The Joule is the International System (S.I.) unit of energy. It is best expressed in millions, as MegaJoules (MJ) because this is a more practical unit. The conversion rate to the more familiar kWh is  $3.6 \text{ MJ} = 1 \text{ kWh}$ . For conversion of units: see Appendix G.

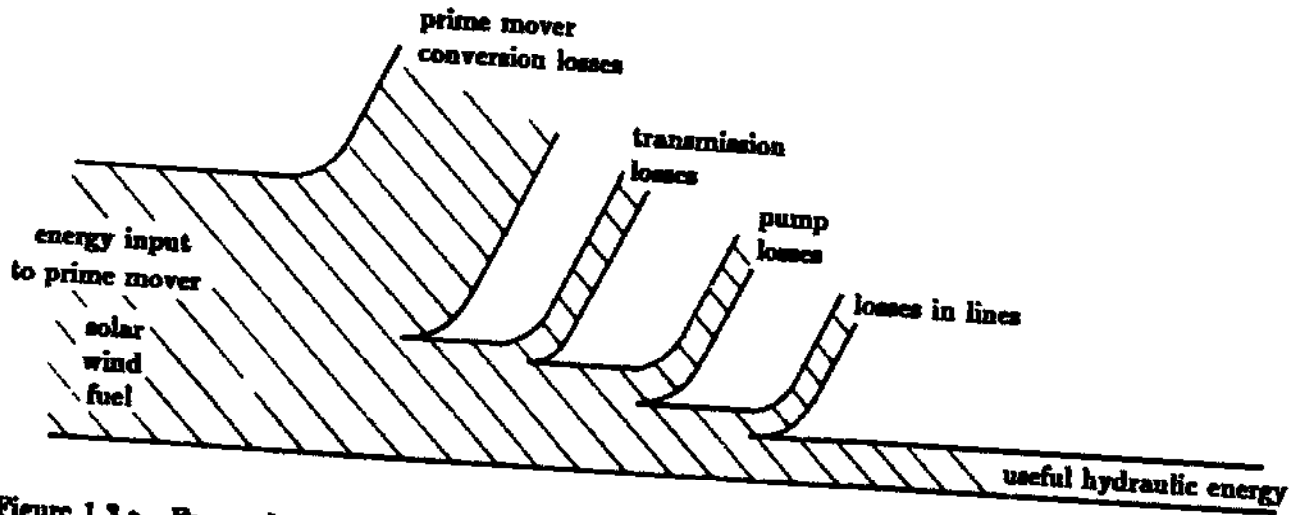

Figure 1.3.a. Energy losses in a water pumping system.

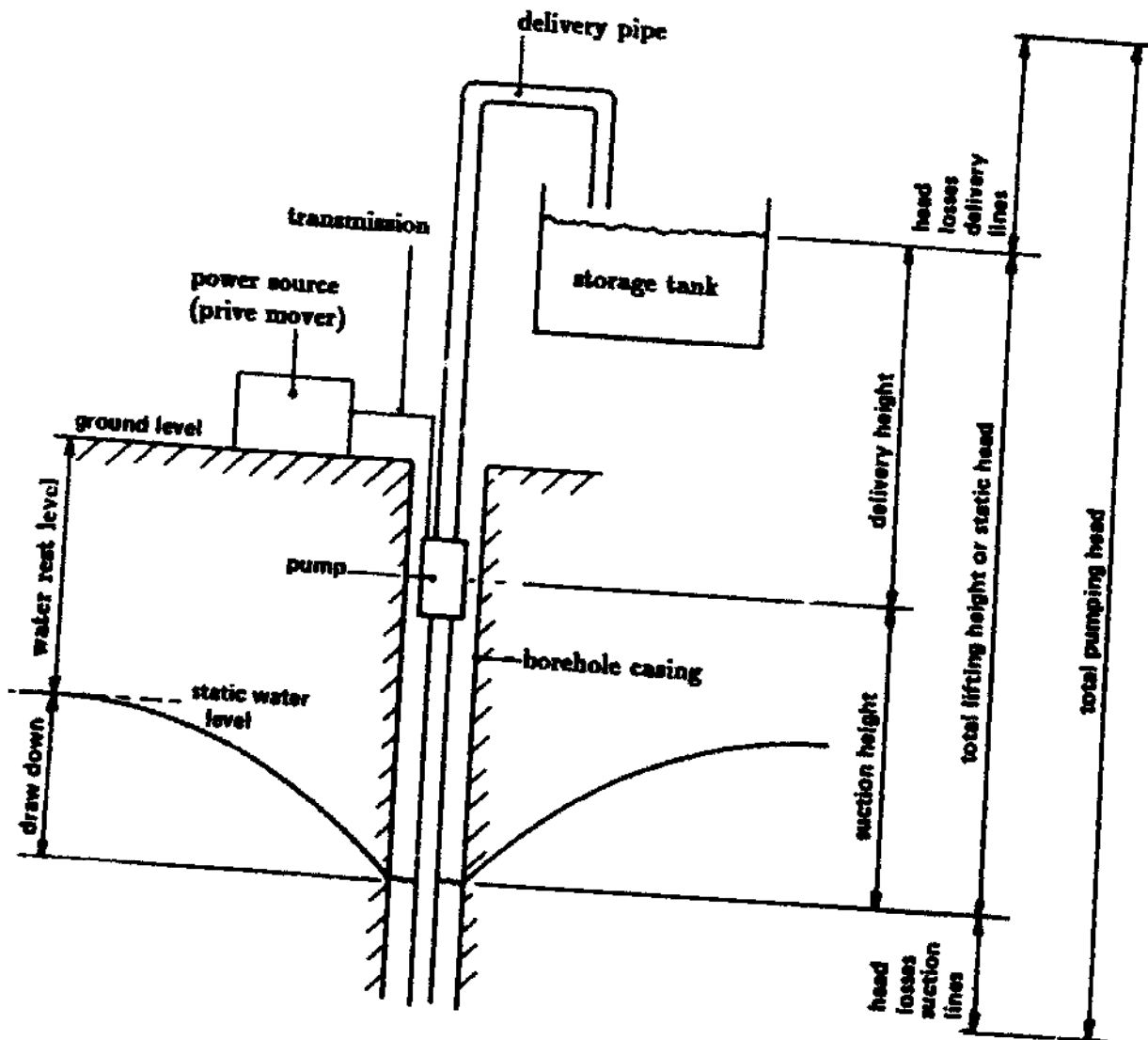

Figure 1.3.b. Composition of total pumping head.

In addition to energy conversion losses, a proportion of the pumped water may be lost in the process of delivering the water to its point of use. This will have a direct effect on the energy required for pumping and since, as will be shown in later chapters, the input energy requirements have a large influence on water costs, the efficiencies with which energy is converted and with which water is distributed, are of major importance.

Power is the energy spent per unit of time. In other words power is the rate of energy supply, so the formula for hydraulic power is simply obtained from the formula for energy (1.1a) by replacing volume  $Q$  with flow rate  $q$ , in cubic meters per second.

$$P_h = \rho g H q \text{ (Watts)}$$

in which:

$P_h$  is the hydraulic power in Watts

$q$  is the flow rate or volume of water lifted per second in  $m^3/s$ .

So:

$$P_h = 9.8 \cdot 10^3 H q \quad \text{(Watts)} \quad (1.1b)$$

$$P_h = 9.8 H q \quad \text{if } q \text{ is expressed in liters per second} \quad (1.1c)$$

$$P_h = 0.113 H q \quad \text{if } q \text{ is expressed in } m^3 \text{ per day} \quad (1.1d)$$

**Example:**  $q = 1 \text{ l/s}$  ( $10^{-3} m^3/s$ ),  $H = 10 \text{ m}$  gives  $P = 98 \text{ W}$  or as a rule of thumb approx.  $100 \text{ W}$ . With this small power ( $98 \text{ W}$ ), and at the given height, an amount of water can be pumped during a day equal to  $86.4 m^3/\text{day}$ . This is approximately the daily water requirement for crop irrigation of one hectare (2.5 acres). The corresponding hydraulic energy requirement is 8.47 megajoules (MJ) or 2.35 kilowatt hours (kWh).

Both energy and power are important characteristics to describe a pumping system. Energy determines the total amount of water that is pumped against a given head, the amount of fuel or human labour that has to be paid for. Power represents the rate at which energy is used. The average power demand in a period is an indication of the size of a water pumping device that is required to fulfil the demand in that period (a 3 kW diesel or a 1 kW peak solar panel or a 5 m diameter wind pump), assuming that solar and wind conditions are known.

The head, as we have seen, has a proportional effect on the power requirements and likewise on the cost of water. It is the sum of the total static head and the head loss due to friction losses in the piping (Figure 1.3.b). The static head is simply the physical height over which the water has to be lifted, including the so-called drawdown of the water level in the well due to pumping. The head loss related to the pressure losses in suction and delivery lines depends on the flow rate through the pipes. It can be limited by an appropriate sizing of the piping system that is to say, the diameter of the pipes should be made larger to adjust for the head loss.

**Note:** The hydraulic energy equivalent which was introduced in this paragraph, is used to indicate the net hydraulic energy output. In that sense lifting  $367 m^3$  over 1 m head is equivalent to lifting  $3.67 m^3$  over 100 m. However, in practice the real energy input requirements are not the same. The type of pump needed for a low lift/high volume application is completely different from that for high lift/low volume pumping. These pumps do not have the same efficiency.

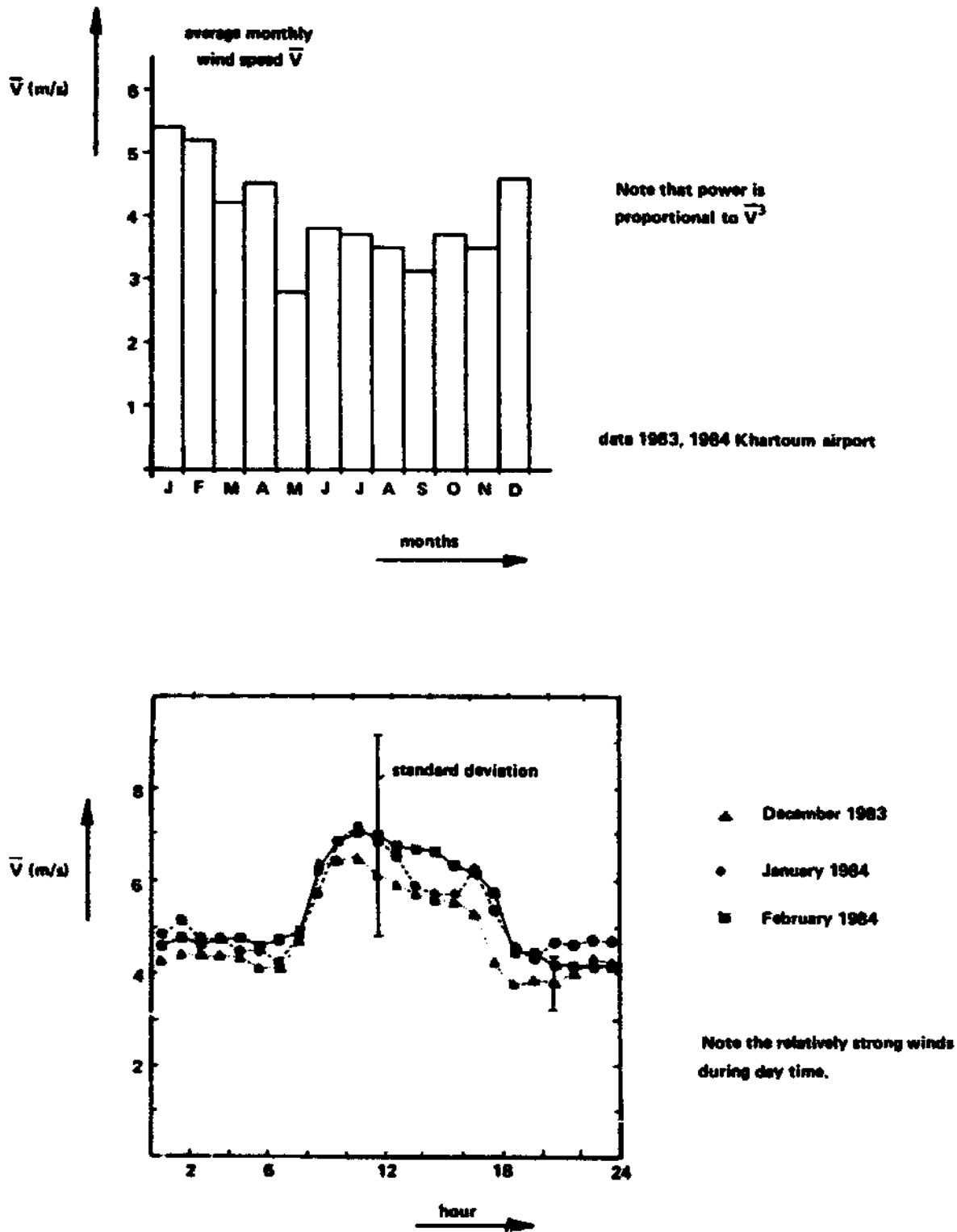

Figure 1.5. Examples of monthly and hourly variations of wind speed, Khartoum (reference 7a). The average course of the wind speed during the day is called the diurnal wind course or diurnal wind pattern.



### 1.3. Evaluating a wind site

An ideal site for a wind pump is an open, exposed area, where the wind blows freely. Sheltered locations (in woods or valleys) are generally unsuitable.

The problem in calculating how much wind is available at a site is that existing wind speed data are often unreliable. But the correct evaluation of wind resources is essential to determine the economic viability of using wind energy for water pumping. The cost of water from a wind pump is very sensitive to monthly average wind speed.

The amount of wind available at a site is influenced by overall wind patterns, by the general topography of land surrounding the site, and by whether a site is open or has obstacles such as trees or buildings.

Compared to solar energy, wind energy is very unevenly distributed in space and time. In tropical areas, daily solar irradiation differs by a factor of three: 24 MJ per day for very sunny spots against 8 MJ per day for poor locations. On a day-to-day basis at a site, the differences are at most a factor of 4.

Variations in wind power are of another order of magnitude. Very windy regions (e.g. trade winds) have a potential 100 times higher than very low wind regions. On a day-to-day basis at one site the wind potential can vary by a factor of 10 to 100 (or more if storms are included).

Because wind patterns are so varied and complex, the task of evaluating wind potential is also complex (see Appendix A).

Global wind patterns are really the movements of air masses generated by the uneven distribution of solar irradiation over the earth's surface. In the regions surrounding the equator, there is a net gain of energy. At the North and South poles there is a net loss. To obtain equilibrium, heat is transported from the equatorial regions to the polar region by the large-scale circulation of the atmosphere and partly by ocean currents. The global wind patterns are further strongly affected by the rotation of the earth.

A world wind map (Figure 1.4)<sup>2</sup> gives annual average wind speeds and wind potential for all areas of the world. However, one cannot rely on such a map for calculating the wind energy available at a given site. The presence or absence of mountains and valleys, the transition from land to water, the type of terrain (forest, desert, etc.) will have a strong influence on local wind patterns.

Seasonal and daily temperature variations can greatly affect the wind patterns at a site. For example, along parts of Lake Victoria in East Africa, the wind regime is greatly influenced by the transition from land to lake. During the night and morning, the wind blows weakly from the land towards the lake. Owing to the heating of the land during the day time, the wind direction sways around midday and quite strong winds build up, blowing inwards from the lake over the land in the afternoon.

---

<sup>2</sup>Figure 1.4, Worldwide Wind Energy Resource Distribution Estimates, following  
p. 274.

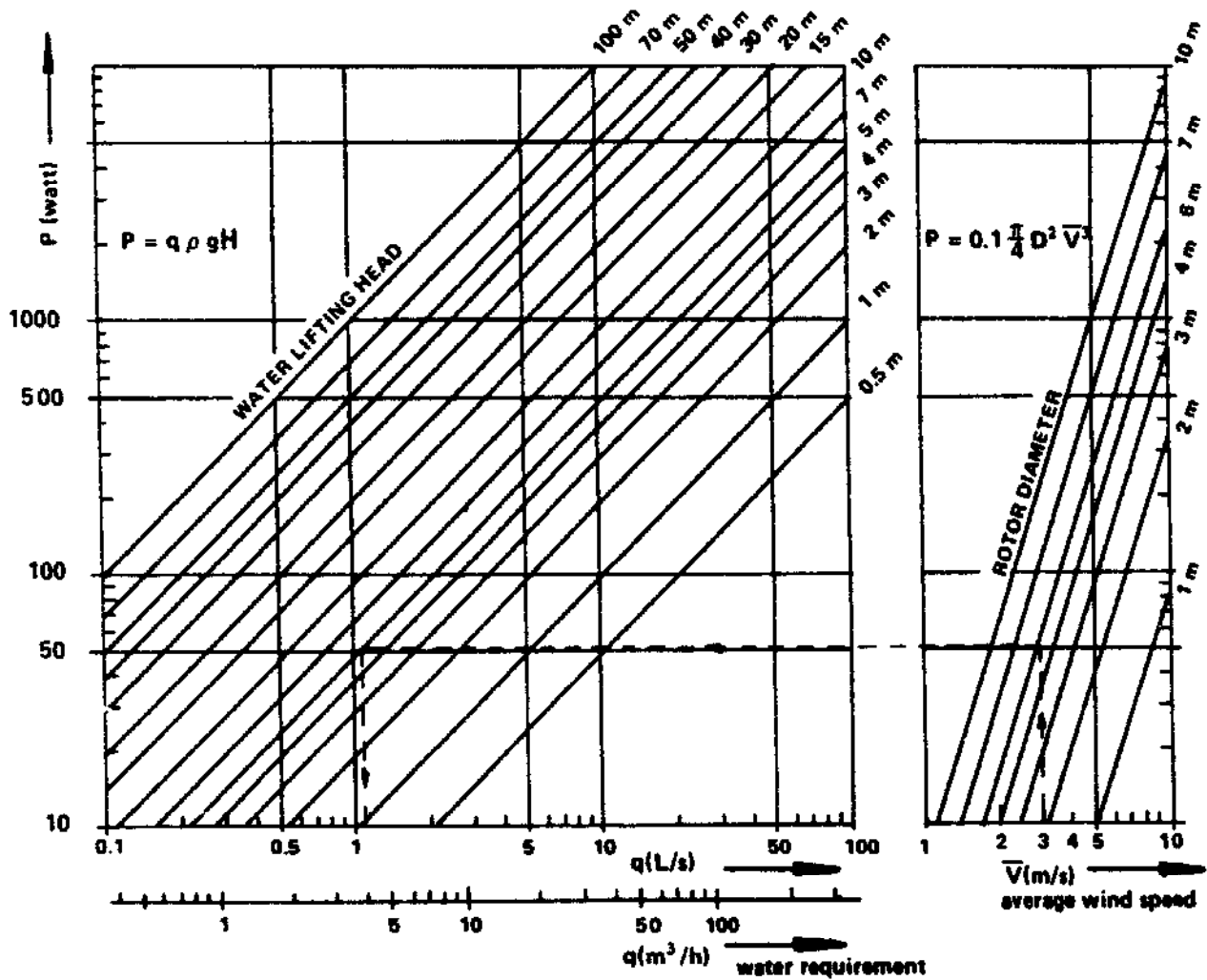

Figure 1.6. Chart to estimate the output of a water pumping windmill with a given diameter  $D$  and a given water lifting head, operating in a wind regime with an average annual (or monthly) wind speed  $\bar{V}$ . This chart is based upon the rule of thumb:  $P_h = 0.1 \bar{V}^3 A$  (reference 3). The chart can also be used to determine the rotor diameter for a specific water requirement at a site where  $\bar{V}$  is known.

### Calculating the power in the wind

The power in the wind blowing with a wind speed (velocity)  $V$  through an area  $A$ , perpendicular to  $V$ , is

$$P_{\text{wind}} = \frac{1}{2} \rho V^3 A \quad (\text{Watts}) \quad (1.2a)$$

where:

- $P_{\text{wind}}$  is the power in the wind in Watts
- $\rho$  is the density of air (approx.  $1.2 \text{ kg/m}^3$  at sea level)
- $V$  is the wind speed in  $\text{m/s}$
- $A$  is the area under consideration perpendicular to the wind velocity in  $\text{m}^2$ .

If the wind speed doubles, the power is eightfold. From 2 to 3  $\text{m/s}$  the power is more than threefold. From 4 to 5  $\text{m/s}$  it almost doubles. On a stormy day the hourly wind speeds can change from 1 to 10  $\text{m/s}$ , meaning that the power in the wind changes by a factor  $10^3 = 1000$ ! A change of this magnitude does not occur daily, but it reflects the large variations in wind power to be expected at different places and times.

Normally the wind power potential is given as the specific wind power, the power per unit of area. So

$$p_{\text{wind}} = \frac{1}{2} \rho V^3 \quad (\text{W/m}^2) \quad (1.2b)$$

in which  $p_{\text{wind}}$  is expressed in Watts per  $\text{m}^2$ .

Examples of hourly, daily and monthly variations are shown in Figure 1.5 (see also Figure A.4, Appendix A).

The values given in Figure 1.5 are representative for open terrain at 10 m height, which is an international meteorological standard. If a windmill, installed in the region for which the wind data are representative is shaded by trees in the prevailing wind direction, or if the surroundings are covered by bushes or other obstacles, the power in the wind will be reduced.

### Rule of thumb: wind power for pumping water

Notwithstanding the difficulties, associated with the variability of the wind, of evaluating a wind site, it is possible to estimate the average power effectively available for lifting water on the basis of the average wind speed at a site. Suppose the average wind speed over a month or year is  $V$ , then the useful average hydraulic power output  $P_h$  in that same period can be estimated by

$$P_h = 0.1 V^3 A \quad (\text{Watts}) \quad (1.4a)$$

in which  $A$  is the swept area of the wind rotor. This can be expressed in another way

$$P_h = 0.1 V^3 \quad (\text{W/m}^2) \quad (1.4b)$$

$P_h$  denoting the specific average hydraulic power output per  $\text{m}^2$  rotor area.

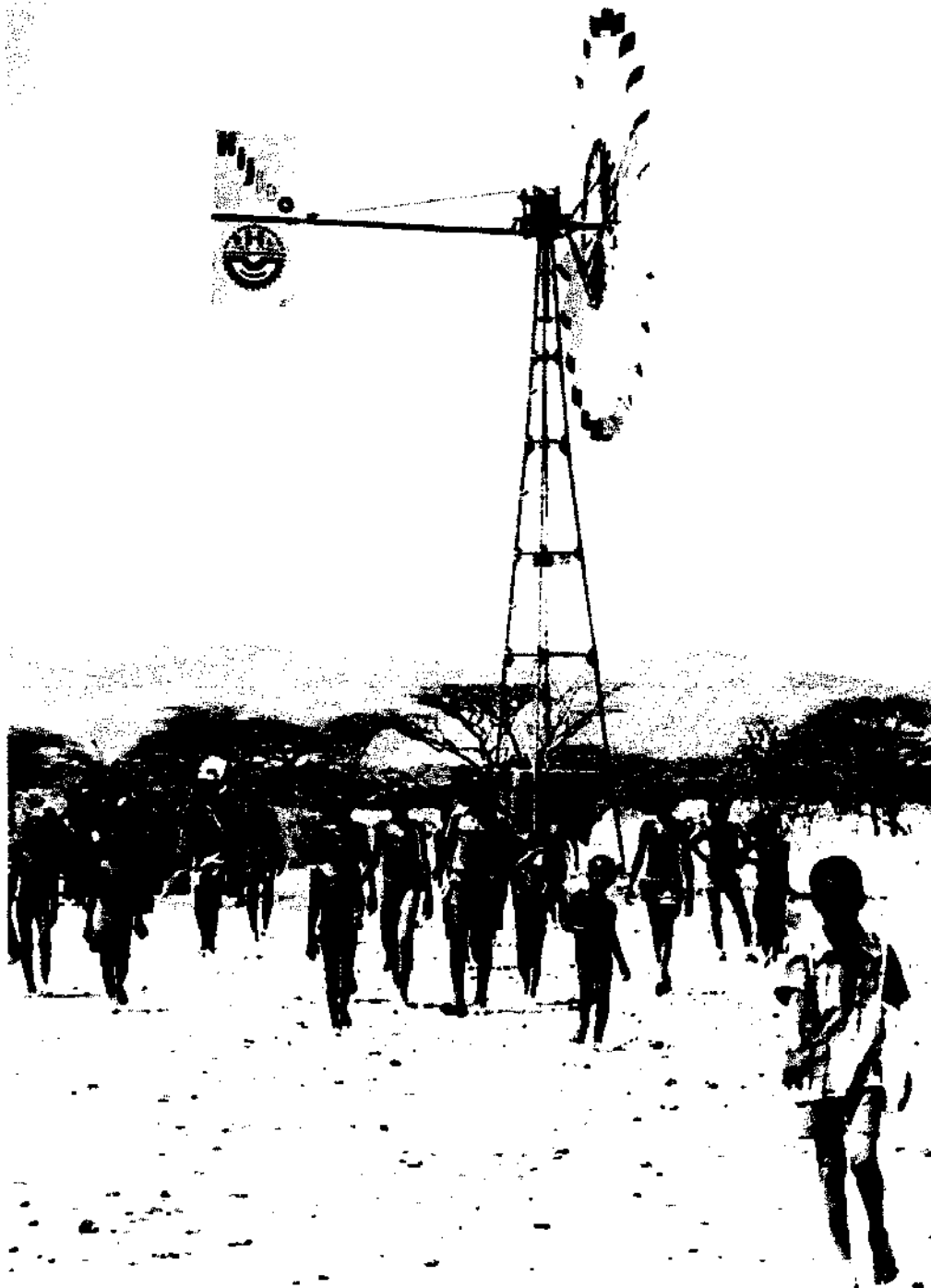

*Water supply in Kenya (photo courtesy of Peter Fraenkel, IT Power).*

Again the sensitivity to the value of the (average) wind speed is noticeable. As an example, Table 1.1 shows the hydraulic power and energy output of a 5 meter diameter wind pump.

Combining (1.1c) and (1.4a) relates the average hydraulic power requirements to the useful average power output of a wind pump; from this the required rotor diameter can be determined if the average wind speed is known. Figure 1.6 shows the results. As will be shown later the factor 0.1 in formula (1.4) is a very rough estimate. In reality, as will be shown, this factor varies from 0.05 to 0.15 depending on the type of wind pump and application at hand.

Note also that the values given in Table 1.1 and Figure 1.6 are potential values as indicated in Section 1.2: the user normally cannot make full use of all the water that the wind pump delivers.

	Average wind speed in a month or year ( $\bar{V}$ in m/s)				
	2	3	4	5	7
Average hydraulic power output $\bar{P}_h$ in Watts	15.7	53.0	126	245	673
Average daily hydraulic energy output in kWh <sub>h</sub> /day	0.38	1.3	3.0	5.9	16.2
Average daily water output for a total lifting head of 10 m in m <sup>3</sup> /day	13.8	46.7	111	216	593

**Table 1.1.** Hydraulic power and energy output of a 5 meter diameter wind pump for different average wind speeds. Rotor area 19.6 m<sup>2</sup> ( $\frac{1}{4} \pi 5^2$ ).  
 At  $\bar{V} = 5$  m/s:  $\bar{P} = 0.1 \times 125 \times 19.6 = 245$  Watts.  
 Note the strong influence of the average wind speed. Going from 4 to 5 m/s doubles the output, from 2 to 3 m/s more than triples it!

## 1.4. Typical water pumping applications

Wind pumps are used to pump water for a variety of applications.

- Domestic water supply
- Water supply for livestock
- Irrigation
- Drainage
- Salt ponds
- Fish farms

Depending on the type of application, different kinds of systems are used. The choice of the type of pump is quite varied (piston pump, centrifugal pump, screw pump, air lift pump) as will be explained in more detail in Chapter 2.

The size of mechanical wind pumps runs from 1 to 8 m diameter. Depending on the pumping height and average wind speeds, the average power output ranges from a few watts to about 1 kW. For higher power demands wind electric pumping systems (WEPS) can be applied, incorporating a wind generator (available in larger diameter) driving an electric motor-pump combination through an electrical transmission. They are already in incidental use in developing countries (e.g. Cape Verde) for average power outputs of up to 10 kilowatts. There is no reason why such systems could not be technically and economically feasible for power outputs of tens of kilowatts and up. It could be anticipated that at such power levels the pumping system is integrated with a small electric grid, supplying electricity for other purposes than water pumping alone.

For mechanical wind pumps the average daily output ranges from 30 to 10.000 m<sup>4</sup> per day, or roughly from 0.1 to 30 kWh<sub>h</sub> per day. It is probable that wind-electric pumping systems eventually will partly overlap this range, say from 10 to a few hundred kWh<sub>h</sub> per day. This corresponds to rotor diameters from about 5 - 30 m diameter.

### Rural water supply

Water demand for livestock and domestic purposes is more or less constant throughout the year. Typical water demands for a village of 500 inhabitants are of the order of 20 m<sup>3</sup> per day. At a head of 20 m the daily hydraulic energy requirements are 400 m<sup>4</sup> or just over 1 kWh<sub>h</sub> per day, equivalent to an average power requirement of 40 W. In many cases water depths are much greater, up to 100 meters.

Reasonable costs of pumping water run up to US \$ 1.- per m<sup>3</sup>, especially in very arid zones; in exceptional cases costs can be even higher. In rural water supply systems storage tanks are normally included, even for engine-driven pumps (because of the risk of breakdowns or lack of fuel), but not for hand pumps.

## **Irrigation**

Demands for water for irrigation are seasonal. Average demand in a peak month can be 2-5 times higher than the average demand over a year. In general unit water costs for irrigation should be well below \$ 0.10/m<sup>3</sup>. This implies that pumping water by any pumping device from great depths, say more than 30 m, is normally not economically viable for small-scale irrigation. If wind pumps are used for irrigation, normally a storage tank must be included in the system.

### **1.5. Viability of wind pumping**

Assuming that different options for pumping water are available (solar pumps, engine-driven pumps, hand pumps etc.), the choice of a particular system centers on the question:

**"Which system provides water reliably at the lowest cost?"**

For the purpose of this handbook the question would run:

**"Does a wind pump provide water at a cost competitive to the cost of water provided by alternative methods?"**

It is impossible to answer these questions in general terms, as an analysis of the financial viability involves so many parameters that differ from place to place: interest rates, import duties, fuel costs, labor costs, material costs, subsidies. Besides the costs, the availability of certain assets can be of paramount importance: e.g. foreign currency, fuel, spare parts. All these aspects cannot be treated in depth in this handbook.

Table 1.2 gives the reader a rough indication of the comparative cost effectiveness of different pumping methods. It may help to eliminate certain options at a first glance and show which options merit further study. It is based on the economic assessment of wind pumps given in Chapter 4 and Appendix C.

To be able to use Table 1.2 the following data should be available:

- 1. Average daily hydraulic energy requirements for each month of the year, expressed in m<sup>4</sup> per day. To find these values multiply the average daily water demand (in m<sup>3</sup>/day) with the total head (in m). For the latter take the total static lifting head and add 20%.**
- 2. Average monthly wind speeds  $\bar{V}$  over the year as shown in Figure 1.5.**
- 3. The critical month -- that month in which the ratio of the daily hydraulic energy demand to the available wind potential of that month is largest. To determine the critical or "design" month, for each month divide the daily hydraulic energy demand by the cube of the average wind speed of the same month ( $\bar{V}^3$ ). The highest value determines the critical month. For rural water supply with a constant water demand the critical month is obviously that with the lowest average wind speed.**

Average wind speed $\bar{V}$ in critical month in m/s	AVERAGE DAILY HYDRAULIC POWER DEMAND IN CRITICAL MONTH					
	20 - 500 m <sup>3</sup> /day		500 - 2000 m <sup>3</sup> /day		2000 - 100000 m <sup>3</sup> /day	
	Rural water supply	Irrigation	Rural water supply	Irrigation	Rural water supply	Irrigation
> 5	Wind best option	Wind best option	Wind best option	Wind best option	Wind best option	Wind best option
3.5 - 5	Wind best option	Wind probably best option but check with kerosene and diesel	Wind best option	Wind probably best option but check with kerosene and diesel	Wind very good option but check with diesel	Wind very good option but check with diesel
2.5 - 3.5	Consider all options wind, solar, kerosene, diesel	Consider all options wind, solar, kerosene, diesel	Consider wind, diesel, kerosene	Consider wind, diesel, kerosene	Consider wind and diesel	Consider wind and diesel
2.0 - 2.5	Consider solar, diesel, kerosene, check wind	Consider solar, diesel, kerosene, wind doubtful	Consider diesel, kerosene, check wind	Consider diesel, kerosene, wind doubtful	Diesel best option, wind doubtful	Diesel best option, wind doubtful
< 2.0	Consider solar, kerosene, diesel	Consider solar, kerosene, diesel	Consider kerosene, diesel	Consider kerosene, diesel	Diesel best option	Diesel best option

- 1) Always consider hand pumps below 100 m<sup>3</sup>
- 2) Electric pumping is nearly always the best option if:
  - a regular supply of electricity is guaranteed by the utility
  - the distance between the pumping location and a normal grid connection is small

Table 1.2. Preliminary assessment of using wind pumps <sup>1</sup>.

<sup>1</sup> This table only gives a very quick, rough first indication. For example, the advice to consider various options does not necessarily mean that the options are equivalent, only that none of the options can be disregarded beforehand. Wind pumps are indicated in a general way without making a distinction between classical and modern wind pumps. When performing a detailed analysis each type of wind pump will prove to have different ranges of applicability, also depending on local conditions (loans, import duties, etc.)



The division into three classes: 20-500, 500-2000 and 2000-100.000 m<sup>4</sup>/day is related to the size of engine-driven pumps. The smallest diesel pump available on the market (about 2.5 kW) determines the transition at 2000 m<sup>4</sup>/day. Below that value the diesel pump is too large for the job and becomes less attractive, partly owing to the relative increase of its annual capital costs, partly owing to its lower efficiencies at partial loading. Similarly the transition at 500 m<sup>4</sup>/day is explained by the smallest kerosene pump available on the market of about 0.5 kW.

Below 20 m<sup>4</sup>/day hand pumps are probably always the best solution. Very large requirements above 100.000 m<sup>4</sup>/day are excluded in the table, since standalone wind pumps are not a very realistic alternative for this range.

The reason for making a distinction between "rural water supply" and "irrigation" is the following:

The water requirements over the year for a rural water supply are more or less constant, implying that the wind pump is used all the year around. In contrast, the demand of water for irrigation is seasonal, so the wind pump will stand idle during part of the year. Considering the high capital investment involved, this puts the wind pump for irrigation at a high disadvantage vis-a-vis diesel.

Table 1.2 should be used with caution, as the following observations make clear:

1. The critical month may coincide with a period of rain. If rain water can be collected for rural water supply, then there may be less need to pump water in that month and another month may become "critical".
2. If fuel is not regularly and sufficiently available at far away places, owing to costs of transport or accessibility, then solar and wind are at an extra advantage; they may in fact be the only effective possibilities.
3. A regular diurnal wind pattern — the course of the wind speed during the day — with strong winds during a few hours per day favors the use of a wind pump even at low average wind speeds (Figure 1.5).
4. Wind pumping is favored if there are other viable locations in the same region.
5. If by using a wind pump, the pumping requirements can effectively be met in all months of a year except for one critical month, it is worthwhile considering a supplementary pumping device for that particular month (e.g. a hand pump), before rejecting wind pumping altogether.
6. The costs of water storage have a pronounced effect on the resulting water costs.

## Conclusions

Some general conclusions about the viability of wind pumping can be summarized as follows:

- 1a. Because the average power in the wind is proportional to the average wind speed cubed, a small error in estimating the wind speed leads to a relatively large error in estimating wind energy potential. Therefore, correct calculation of wind speed is essential.
- 1b. Available wind resources must be correctly assessed. If necessary, consult an expert.
- 2a. The economics of using wind pumps for rural water supply is less critical than for irrigation. The seasonal requirement of water for irrigation puts the capital cost of the wind pump at a disadvantage compared with the diesel-powered pump.
- 2b. Wind energy seems the best option for water pumping in all cases if the average wind speed in the critical month is 5 m/s or above.
- 2c. Modern wind pumps, especially if manufactured locally, will generally pump water at lower costs than imported classical multibladed windmills. This distinction should be considered in assessing the potential of wind energy for water pumping. It should be noted that the long experience with classical wind pumps presently guarantees a higher reliability than for modern wind pumps, although maintenance itself could be more difficult owing to the need to import spare parts. After making a preliminary assessment of the viability of wind pumping, it is advisable in most cases to make a more detailed analysis, taking into consideration local production or import of either modern or classical wind pumps. This is especially true for the cases mentioned below under 2d through 2f.
- 2d. Below 2 m/s in the critical month wind energy for water pumping is generally not economically feasible.
- 2e. At average wind speeds in the critical month above 3.5 m/s, wind pumps are generally a very good option.
- 2f. At average wind speeds in the critical month between 2 and 3.5 m/s it is impossible to make general statements on the economic viability of using wind energy for water pumping. Check all options as indicated in Table 1.2.
- 2g. Wind pumps are particularly attractive at low hydraulic power requirements. At very low requirements ( $< 20 \text{ m}^4$ ), however, it is better to use hand pumps.

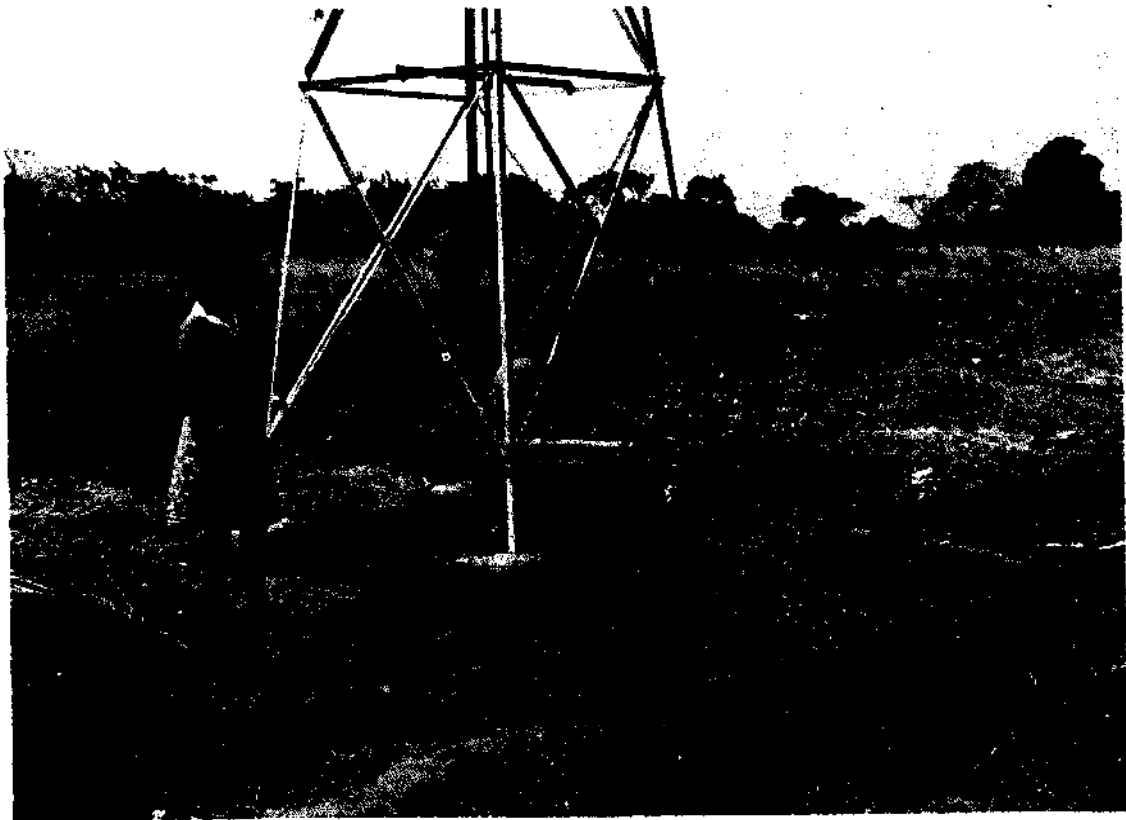

*Wind pump irrigation in Sri Lanka.*

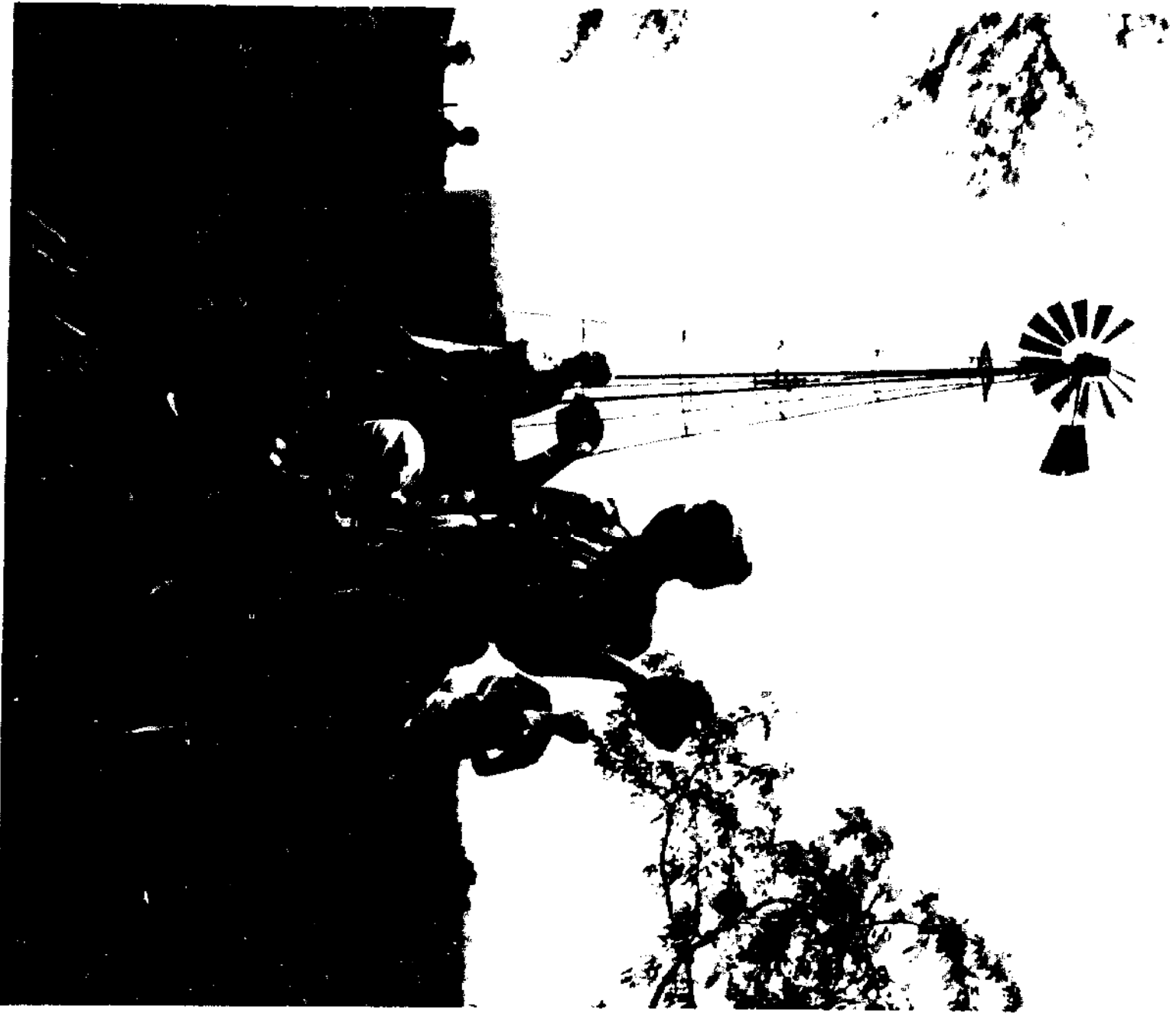

*A Dempster wind pump at the reforestation tree nursery of São Filipe, Cape Verde.*

## Chapter 2

# WIND PUMP TECHNOLOGY

This chapter describes the various components of a wind pumping installation — the windmill, the transmission, the pump, the storage tank, and the distribution system. The type of windmill referred to during most of the discussion is the classical horizontal axis windmill with a mechanical transmission driving a piston pump. This is the only type of windmill in widespread use for which a reasonable amount of validated experience is available. However, for the sake of completeness, the chapter begins with a brief description of the five different types of wind pumps currently being used around the world.

Section 2.1 describes the five types of wind pumps in use today. The remaining sections focus exclusively on the piston pump windmill. Section 2.2 describes the components and characteristics of the windmill. Section 2.3 covers the piston pump and its characteristics. Section 2.4 gives details on how to match windmill and pump. Section 2.5 gives technical data on wind pump performance. Section 2.6 describes storage and water distribution. Section 2.7 discusses briefly the relative advantages of the classical windmill and the "modern" windmills of innovative design.

It is important to consider the wind pump installation as a whole, because the total cost of the installation gives the truest picture of what it costs to use wind power to assure a given supply of water. A key consideration is the rotor area of the windmill. The investment cost for a wind pump system is roughly proportional to the rotor area. The total energy production of a wind pump (or amount of water pumped over a certain height) is directly proportional to the rotor area. This means that the design of a windmill installation requires more accurate information on total water consumption than is normally needed for an installation using an engine-driven pump. The amount of water one needs influences the size of rotor one must select, which influences the cost of the windmill. Another important consideration is storage. While storage is not always needed when engine-driven pumps are used (an engine-driven pump can be started up whenever water is needed), a windmill would be practically useless without a storage tank. A windmill only pumps when wind is available. So, a storage tank must be built large enough to store surplus water during periods of strong wind for later use when there is less wind or no wind at all. Figure 2.1. shows an example of the layout of a wind pumping system.

The matching of windmill and pump is of the utmost importance for a satisfactory performance. Choosing a large pump leads to a high pumping rate when the windmill is running, but on the other hand the windmill will often be standing still if the wind is not sufficient to start the large pump. Choosing a small pump means starting will be easier and the windmill will run more hours, but the pumping rate during those hours will be lower. The optimal choice of the size of the pump depends on the wind regime: for strong winds one may use a larger pump than for weak winds. Wind pump sizing is discussed in detail in Chapter 3.

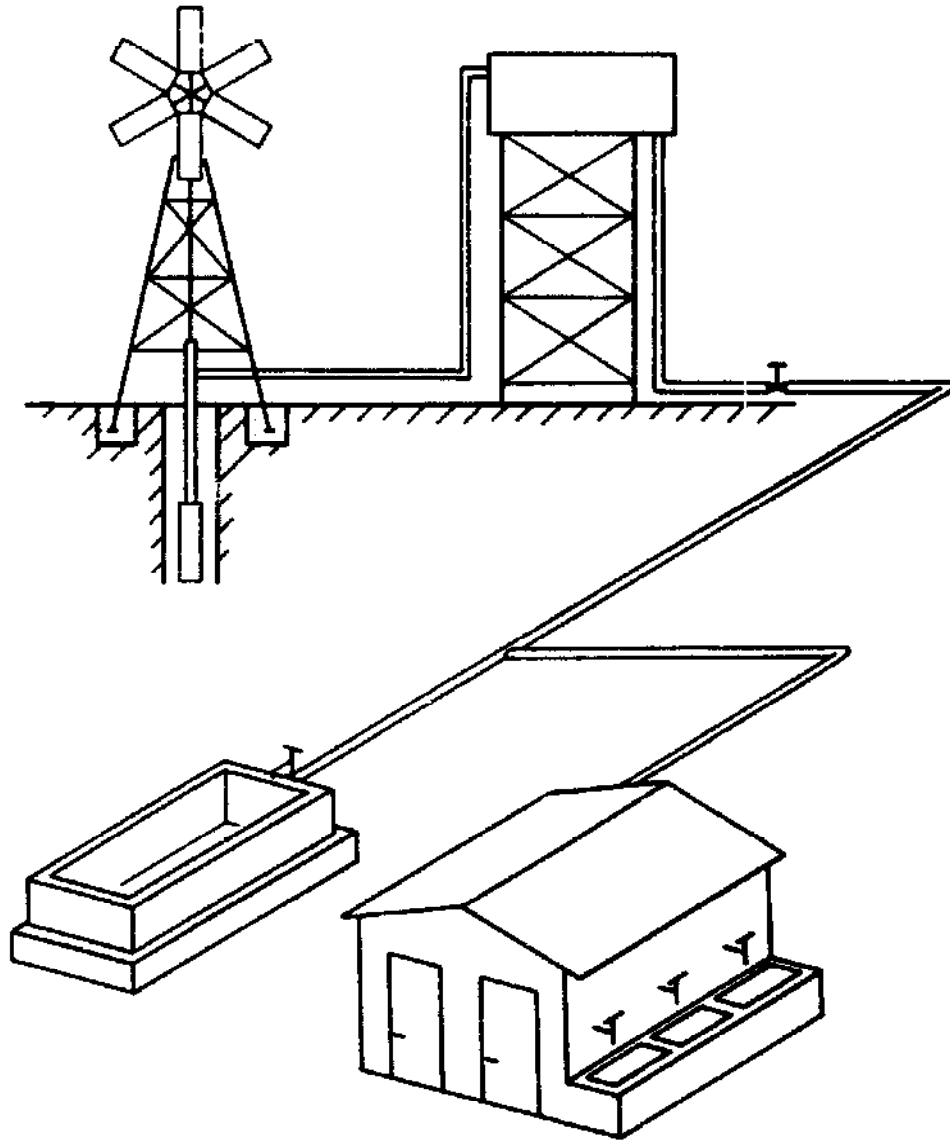

**Figure 2.1. Schematic layout of wind pumping system for water supply for domestic use and livestock.**

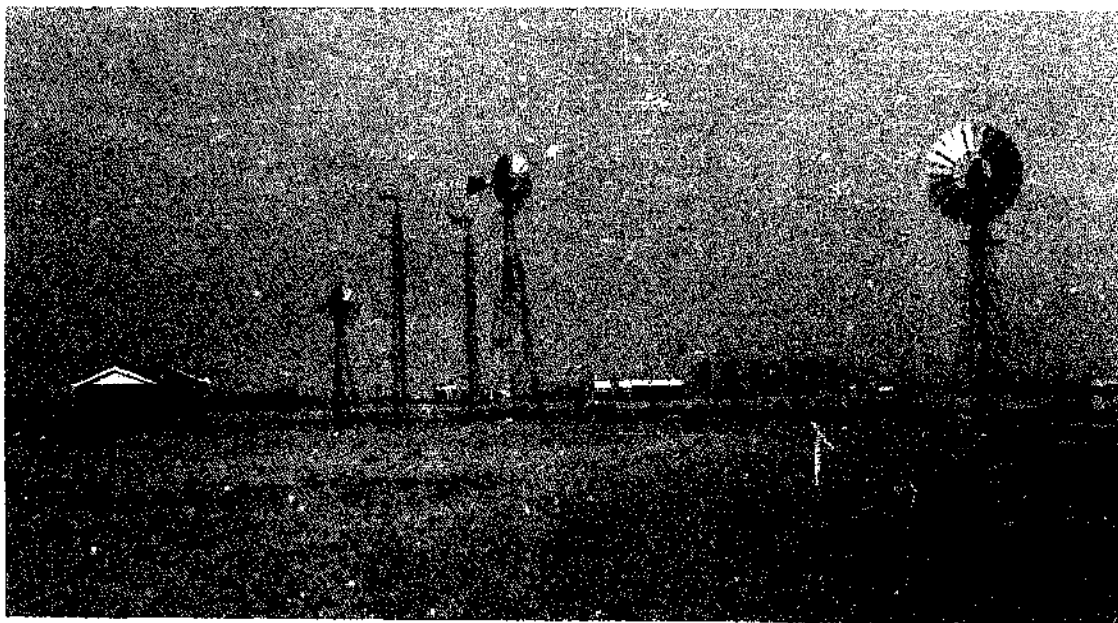

*Various types of mechanical wind pumps (Almere testfield, Netherlands).  
From left to right: Oasis, Fiasa, Southern Cross.*



*Bosman wind pump driving a centrifugal pump. Thousands are in use in the Netherlands  
to pump water from the drainage canals of the polder over heights of 1 m or less.*

**Figure 2.2.** Photographs of mechanical wind pumps.

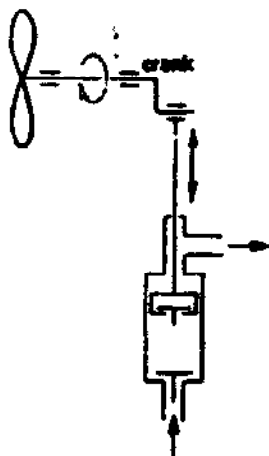

**Windmill driving a piston pump:  
most common type**

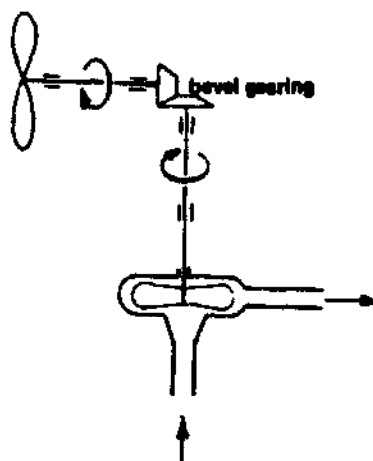

**Windmill with a rotating transmission:  
low head/high volume**

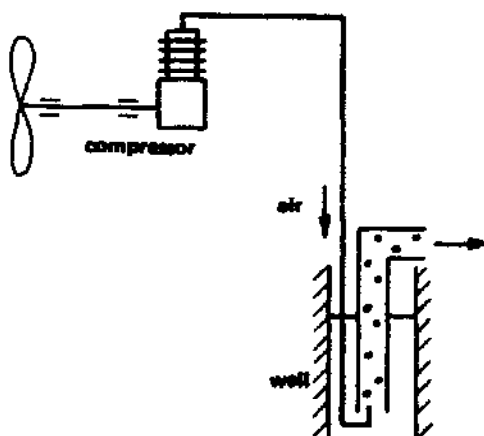

**Windmill with a pneumatic transmission, driving  
an air lift pump: no moving parts in the well**

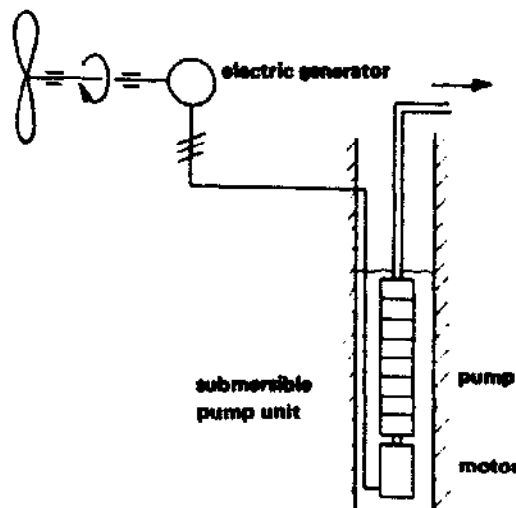

**Wind electric pumping system:  
remote pumping, large flow rates**

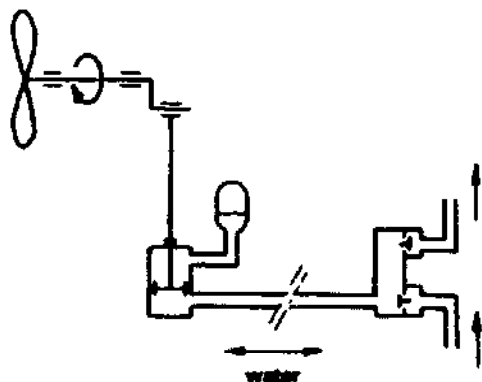

**Windmill with a hydraulic transmission:  
experiments with remote pumping**

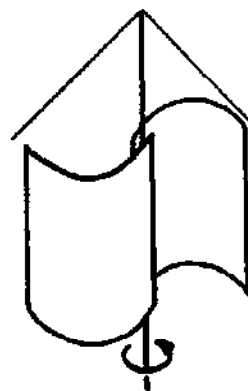

**Savonius rotor:  
of no practical interest**

**Figure 2.3. Types of wind pumps classified according to type of transmission.**



## 2.1. Types of wind pumps

A variety of wind machines are being used for water pumping. A convenient classification can be made on the basis of type of transmission between the wind rotor and the pumping device (Figure 2.3).

- o **Windmills driving piston pumps.** The wind rotor is coupled mechanically (directly, or through a gear box) to the piston pump. This is by far the most common type and will be discussed in more detail in the following section.
- o **Windmills with rotating transmission.** The wind rotor transmits its energy through a (mechanical) rotating transmission to a rotating pump, for example a centrifugal pump or a screw pump. Both are used especially for low head/high volume applications.
- o **Windmills with pneumatic transmission.** A few manufacturers fabricate windmills driving air compressors. The compressed air is used for pumping water by means of an air lift pump (basically two concentric pipes), or a positive displacement pump (basically a cylinder with a few valves). This type of transmission allows the windmill to be installed at some distance from the well. Another advantage is the absence of pump rods, and — in case of an air lift pump — of any moving part inside the well.
- o **Wind electric pumping systems.** Wind electric generators are sometimes used to drive electric pumps directly (without being coupled to an electric grid). Again, this transmission provides the freedom to install the wind machine at a windy site at some distance from the well. Electric submersible pumps may be used to pump water from narrow boreholes, with flow rates far in excess of those attainable with piston pumps.
- o **Windmills with hydraulic transmission.** Several experiments have been performed on remote pumping by means of a hydraulic transmission. Mostly water is used as the operating fluid.

The types of windmills described above are all horizontal axis windmills. At the moment these are the only types of practical interest for water pumping. In the past quite some research effort has been put into vertical axis machines for pumping, especially Savonius rotors. However, this has not led to practical applications for two main reasons: high cost per unit of water pumped (heavy machines combined with low efficiency), and poor reliability (it is difficult or impossible to incorporate a safety system in such a design). Vertical axis Darrieus wind rotors are hardly suitable for a water pumping system, as they need an external power source for starting. Therefore, vertical axis machines will not be mentioned further in this handbook.

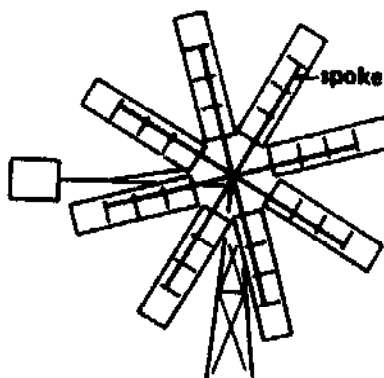
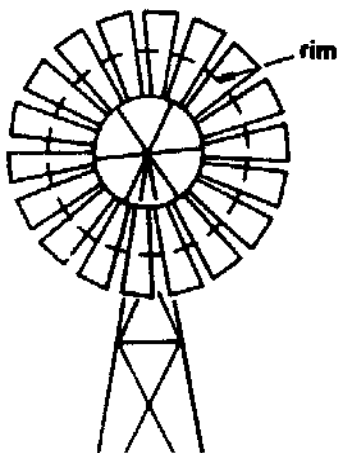

**Classical multiblade rotor (heavy)**

**Modern rotor (light)**

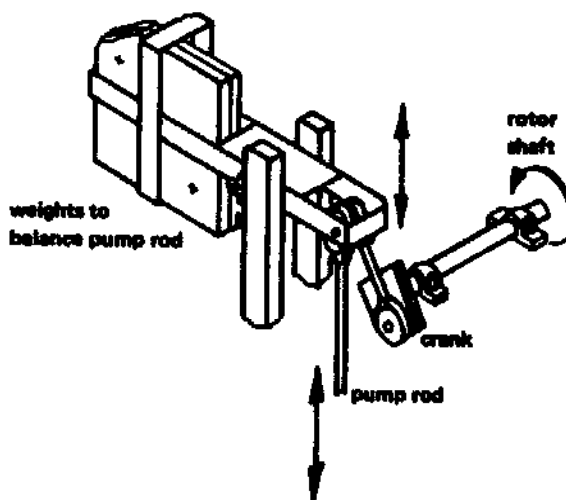
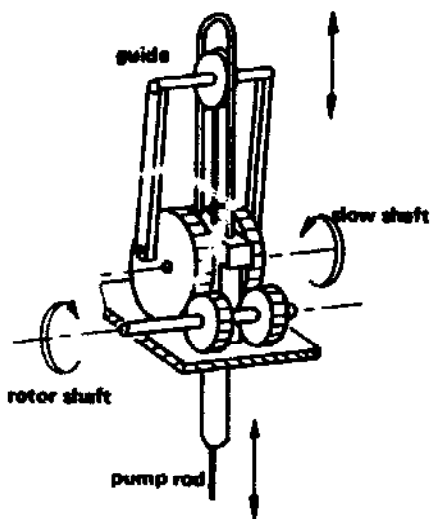

**Transmission of back-gearred windmill running in oil bath**

**Direct drive transmission**

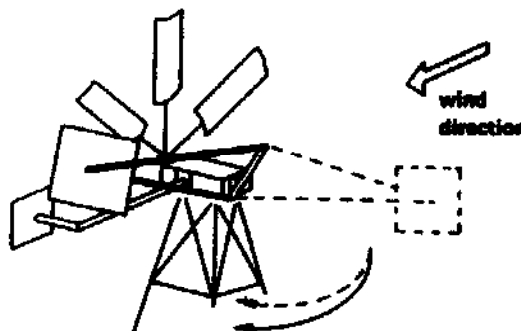
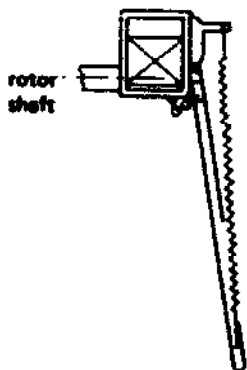
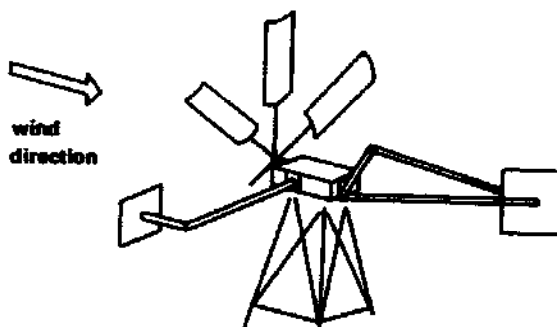
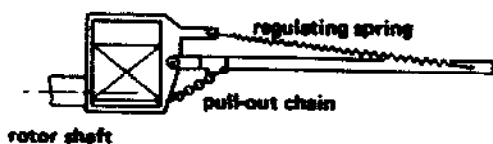

**Top view of ecliptic safety system**

**Hinged vane safety system**

**Figure 2.4. Components of mechanical windmills.**

## 2.2. Prime mover: mechanical windmill

As indicated before, the remainder of this chapter will concentrate on the most common type of wind pump: a windmill driving a piston pump through a mechanical transmission. Where appropriate, however, reference will be made to the other types. Figure 2.2 shows some photographs of such mechanical wind pumps (including one with a rotating transmission and a centrifugal pump).

In this section we will discuss the components and subsequently the characteristics of mechanical wind pumps. The piston pump, which actually lifts the water, is described in Section 2.3.

### 2.2.1 Windmill components

A windmill consists typically of the following components (see Figure 2.4):

- The rotor, which captures the wind's energy and converts it into mechanical energy.
- A transmission, which conveys the energy from the rotor to the pump, sometimes involving intermediate energy conversions.
- The safety system, which protects the windmill during gusts and storms.

#### Rotor

The rotor is the essential part of this prime mover: it converts the power of the wind into useful mechanical shaft power.

Usually the blades consist of curved steel plates. Sometimes sails are used. Classical "American" windmills have 15, 18, 24 or even 36 blades, mostly supported by a structure of spokes and rims. These rotors deliver maximum power when the speed of the blade tips approximately equals the wind speed. Recent designs have less blades: 4, 6, 8, or 12, mostly supported by spokes only. These rotors operate at higher tip speeds: For any given wind speed, maximum power is delivered when the speed of the blade tips equals 1.5 to 2 times the wind speed.

The rotor is fixed to a steel shaft by means of one or two hub plates. The shaft is supported by sleeve bearings (receiving oil from the gear oil bath), or by roller bearings (lubricated by grease or by oil), or by hardwood sleeve bearings (lubricated with oil). Rotors of water pumping windmills range from 1.5 to 8 m diameter.

In a 4 m/s wind, a rotor of 1.5 m diameter may produce up to 24 W of mechanical power, and an 8 m diameter windmill up to 680 W. In a 5 m/s wind, these values nearly double (46 and 1320 W respectively).

## **Transmission**

The transmission of a windmill conveys the mechanical energy delivered by the rotor to the pump (rod).

Many of the classical "American" windmills, especially the smaller models are "back-geared", i.e. they incorporate a gear box. The gears reduce the r.p.m. of the pump, normally by a factor of about 3. The gears are normally double to avoid uneven loading of the crank mechanism (see below) and usually run in an oil bath for lubrication. The oil needs to be changed about once a year.

An essential part of a windmill transmission is some kind of eccentric that transforms the rotating movement of the rotor into a reciprocating movement of the pump rod. Several types exist:

- Two drive rods connected eccentrically to the two slow gears, and connected through a guide to the pump rod (see Figure 2.4).
- A simple crank on the main shaft, connected directly to the pump rod.
- A crank on the main shaft, connected through a guide to the pump rod.
- A crank on the main shaft, connected through a lever system to the pump rod (see Figure 2.4).

The pump rod transmits the power to the pump. Often a swivel joint is incorporated, preventing the pump rod from rotating when the windmill's head assembly is yawing due to a change of wind direction. Normally the pump rod is guided at several points in the tower. The swivel joint and the guides require regular lubrication by greasing, for example once a month. The efficiency of the transmission is somewhere between 70% and 90%.

## **Safety system**

No wind machine can be expected to survive very long without an automatic safety system to protect it against gusts and storms. It would be impractical, even if it were possible, to design a wind machine strong enough to remain in full operation during storms, with an exception perhaps for very small wind machines of 1 m diameter or so. Hand-operated safety systems alone are not sufficiently reliable. Storms may occur very suddenly, unexpected storms may occur at night, and one moment of negligence may reduce an important investment to scrap.

The safety system of mechanical windmills is combined with the orientation system. At low wind speeds the rotor is oriented into the wind; with increasing wind speeds the rotor is gradually turned out of the wind so as to limit the speed of the pump and the forces acting on the structure.

The functioning of these safety systems is based on the equilibrium of aerodynamic forces (acting on one or two vanes and the rotor), and some other force (mostly a spring or weight) that serves to counteract the aerodynamic forces.

Normally the automatic safety system can also be operated manually to stop the windmill.

A mechanical brake is sometimes incorporated in the rotor hub. It is normally operated both by the automatic safety system and by the manual furling mechanism. These brakes are not capable of stopping a windmill in a storm. They merely hold the windmill when it is being serviced or when there is no need of water.

Two important characteristics of a safety system are:

- o The rated wind speed,  $V_r$ , at which the windmill reaches its maximum rotational speed, and hence pumping rate. For higher wind speeds the rotational speed is limited and gradually reduced by the automatic safety system.  $V_r$  is normally 6 to 8 m/s.
- o The cut-out wind speed  $V_{out}$ . At this wind speed the rotor is completely turned out of the wind and stops running. Usual values are 15 to 20 m/s.

### Tower

The three components discussed above (rotor, transmission, and safety system) together form the head assembly of the windmill. It is supported by a tower, which raises the assembly over any obstructions into a fair, unobstructed wind. In addition the tower serves as a rig when installing the pipes of deep well pumps.

Windmill towers are normally of lattice construction, factory welded as complete sections, or bolted together at the installation site. Normally they have four legs, sometimes three. Tower heights range from 6 m for small windmills to 18 m for large windmills. The most common height is around 10 m.

## 2.2.2. Windmill characteristics

As for any prime mover the most important characteristics of a windmill rotor are the torque-speed and power-speed diagrams. These curves depend on the wind speed. In order to summarize a whole set of curves into one curve, the following three coefficients are defined (see symbols below):

$$\lambda = \frac{\Omega \cdot R}{V}$$

Tip speed ratio, the ratio between the speed of the blade tip, and the wind speed.

The design tip speed ratio  $\lambda_d$  is that value of  $\lambda$  for which the power coefficient reaches a maximum (see below). The design tip speed ratio for classical "American" windmills is approximately 1 (slow-running). For more modern wind pumps it is somewhat higher: 1.5 to 2.0.

$$C_p = \frac{P}{\frac{1}{2} \rho A V^3}$$

Power coefficient, the ratio of the mechanical power delivered by the windmill and the reference wind power (i.e. the power in the wind passing through the rotor disk, if the rotor were not present). The maximum power coefficient, reached at  $\lambda_d$ , normally ranges from 0.3 to 0.4.

$$C_Q = \frac{Q}{\frac{1}{2} \rho A V^2 R}$$

Torque coefficient, ratio of the torque delivered by the wind rotor, and a reference wind torque. Since power is equal to rotational speed times torque ( $P = \Omega.Q$ ), a similar relation is found for the corresponding coefficients:  $C_P = \lambda C_Q$ .

For water pumping windmills the starting torque coefficient  $C_Q$  ( $\lambda=0$ ) is of special interest (see Section 2.4). The following rule of thumb is often applied:  $C_Q (\lambda=0) = 0.4/\lambda_d^2$ .

Symbols:	A	rotor area	(m <sup>2</sup> )
	C	coefficient	(-)
	P	power	(W)
	Q	torque	(Nm)
	R	rotor radius	(m)
	V	wind speed	(m/s)
	$\rho$	air density	(kg/m <sup>3</sup> ) approximately 1.2
	$\Omega$	rotational speed	(rad/s)
		( $\Omega = 2.\pi.n$ with n being the number of revolutions per second of the rotor).	

Subscript:	d	design
	Q	torque
	P	power

Figure 2.5 shows some typical examples of dimensionless torque-speed and power-speed diagrams. The rotors of recent design are lighter in construction than classical rotors of the same size. Under identical wind conditions the recent rotors run faster (higher rpm) than classical rotors. Power output is more or less the same, but the starting torque of recent design rotors is lower.

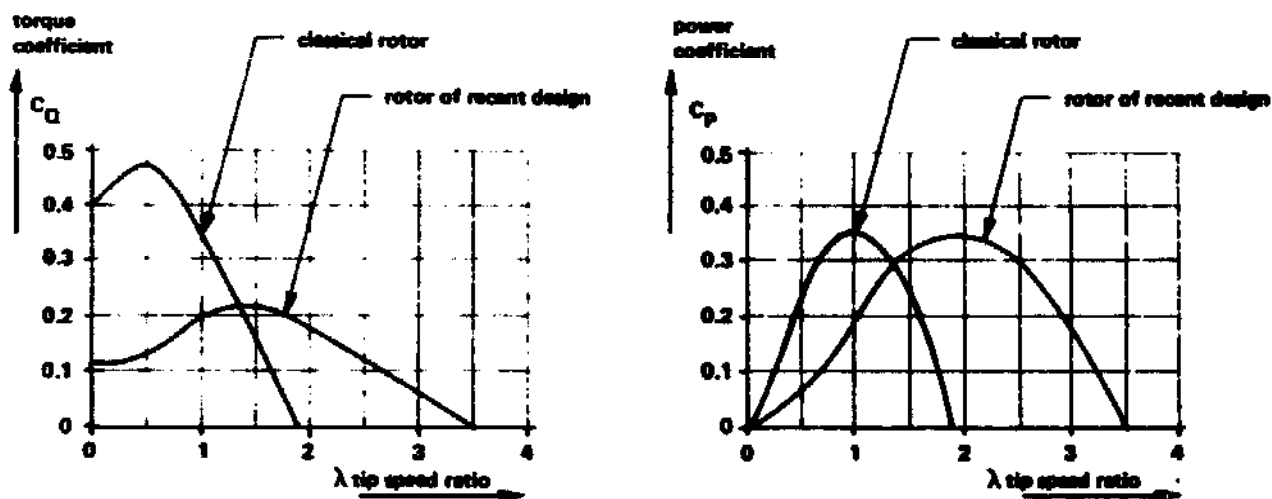
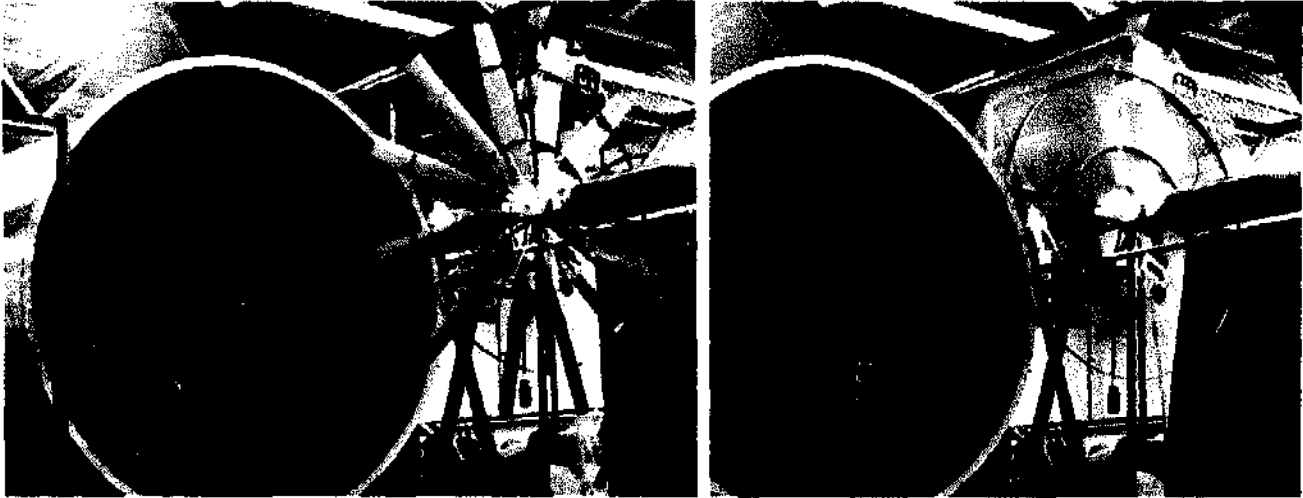
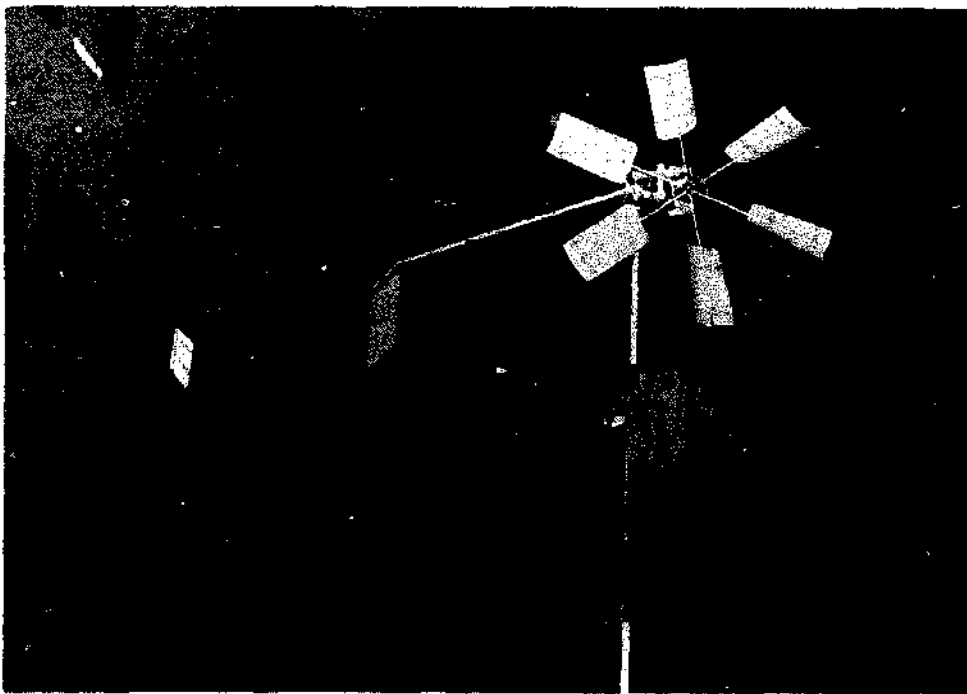

Figure 2.5. Dimensionless torque-speed and power-speed characteristics of wind rotors of mechanical wind pumps.



*Testing of a multi-bladed rotor in an open jet wind tunnel in the Netherlands. Note the rim construction of the rotor.*



*Testing a full scale 2-m diameter wind pump of CWD in the 12x16 m wind tunnel of the Chinese Aerodynamic Research and Development Center (CARD), Mianyang. Note the spar construction of the rotor and the small hinged side vane as part of the safety and control system.*

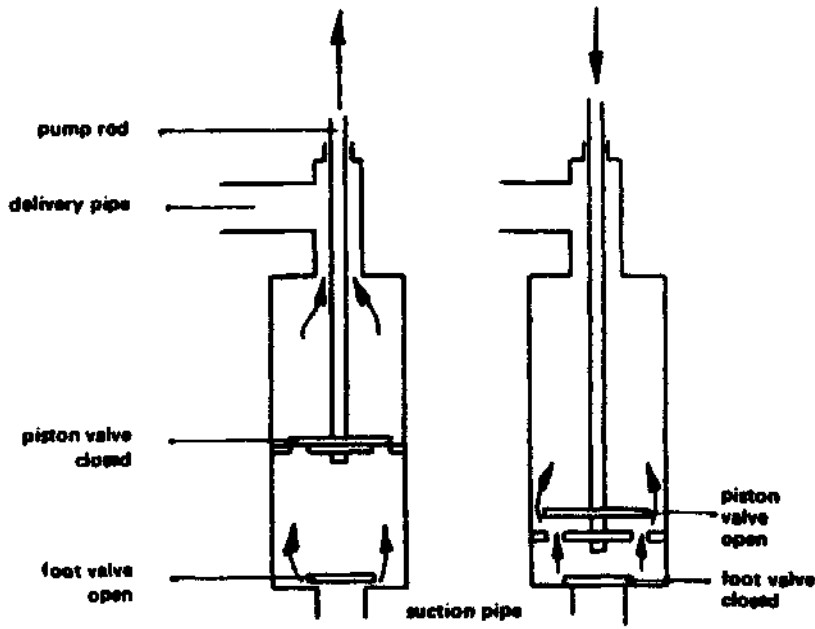

Principle of operation

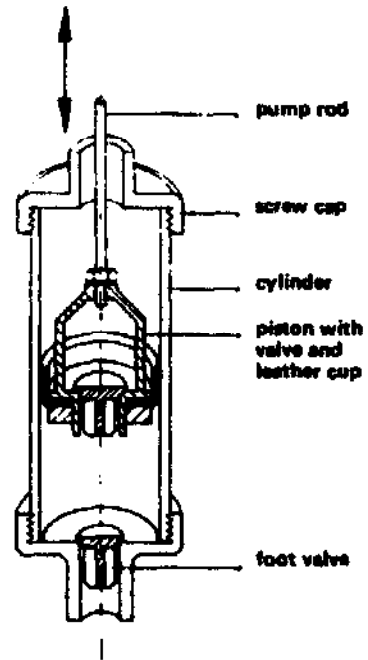

Components of a screw cap pump

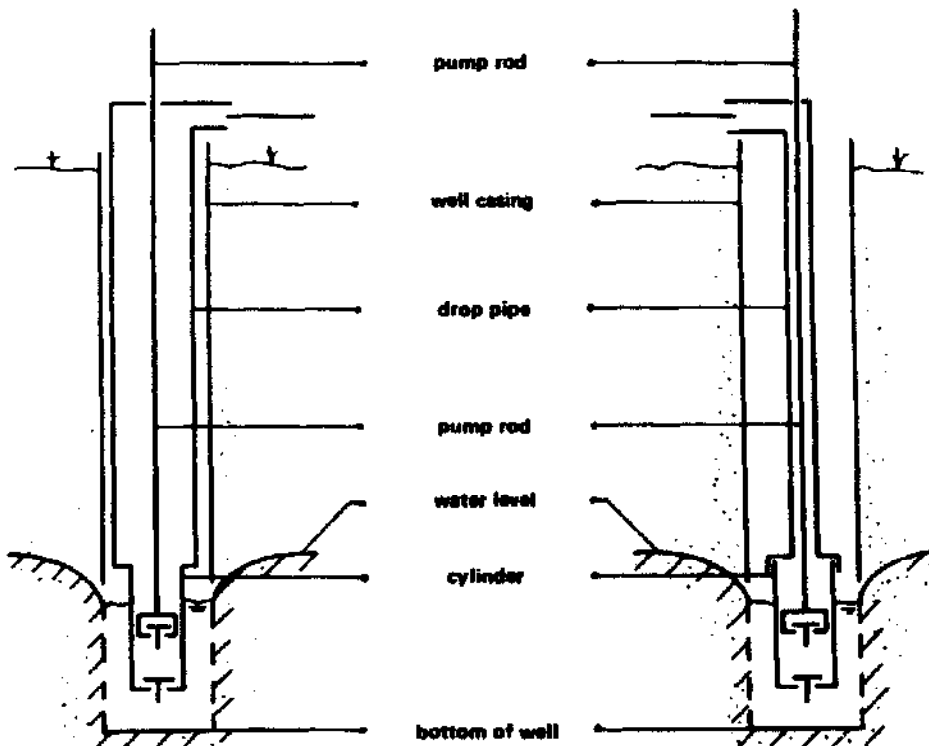

Deep well pump arrangement

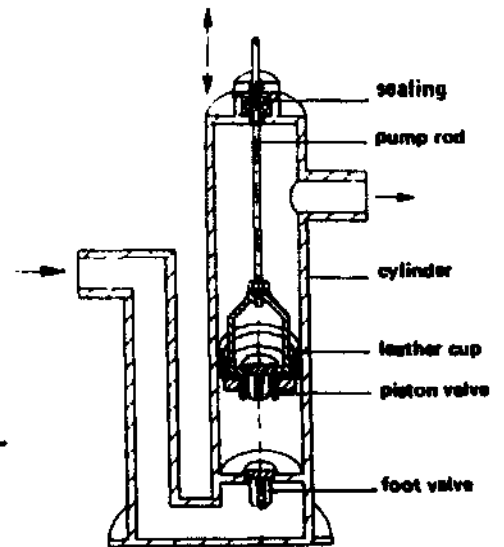

Suction pump

Figure 2.6. Piston pumps used in combination with windmills.



## 2.3. The piston pump

### 2.3.1. Description

The majority of water pumping windmills are equipped with single-acting piston pumps. The upper part of Figure 2.6 shows the principle of operation: When the piston moves down, the foot valve closes and water passes through the open piston valve. On the upward stroke the valve in the piston closes, the foot valve opens, and water is pumped.

A variety of materials is used for the cylinder: brass, stainless steel or PVC pipe but also a bronze bush inside a cast iron cylinder.

The sealing between piston and cylinder wall is normally realized by means of a leather cup. In high-pressure pumps (for large pumping heads) one finds two, or sometimes three cups above each other. The leather cups are subject to wear and must be replaced after six months to two years, depending on the quality of the water.

The piston body and valves are mostly made of brass (cast and/or machined). Valves are normally lined with some type of rubber for better sealing. If the delivery head is higher than the point where the pump rod leaves the delivery pipe, a pump rod sealing is required.

Sometimes air chambers are applied on the delivery and/or suction side of the pump, especially in case of long lines. The air chambers smooth the flow in the lines and reduce those forces in the pump rod that are related to acceleration of the fluid and water hammer effects.

For different applications (with respect to pumping head) different types of pumps are used (Figure 2.6):

- o **Suction pumps**, installed at ground level, for pumping from a maximum of 6 m water depth, from surface water (lakes or canals) or shallow wells. Some models are self-priming. These pumps come in a variety of diameters, up to 350 mm.
- o **Deep well pumps** for installation below ground level in open wells or tubewells. The diameter of tubewells usually limits the outer pump diameter to about 100 to 200 mm. For this application one often finds "screw cap pumps".

For application in very deep tubewells, one often sees "draw plunger pumps", in which the drop pipe is larger than the pump cylinder, and the pump is arranged in such a way that the piston and the foot valve may be lifted without lifting all of the piping.

Maximum pumping depths are 100 to 200 m.

### 2.3.2. Characteristics of a piston pump

A piston pump is a positive displacement pump, i.e. for each stroke the same volume of water is displaced, independent of head or speed of operation.

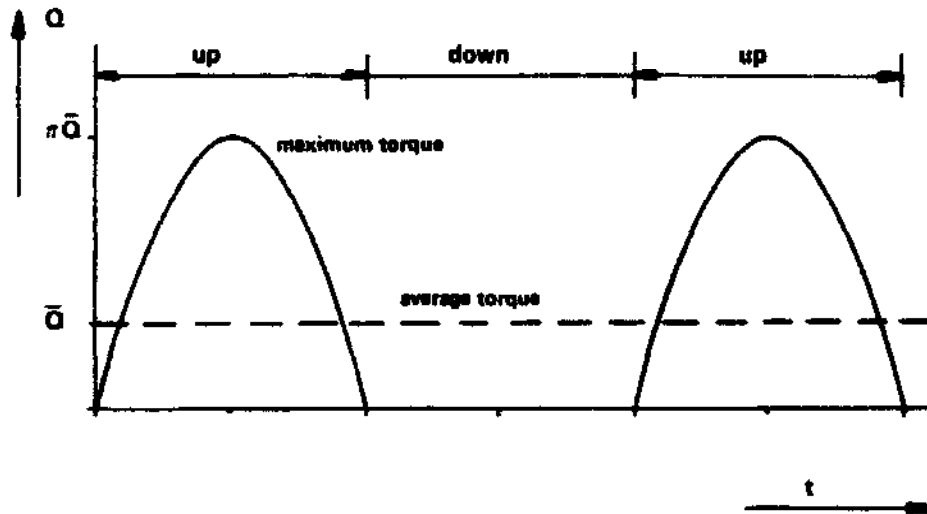

Figure 2.7. Torque of a piston pump versus time.

The torque needed to drive a piston pump is cyclic (Figure 2.7). During the upward stroke the piston is subject to the full water pressure. During the downward stroke the piston valve opens and the torque is virtually zero.

Once a windmill is running it feels only the average torque demanded by the load, because the variations are smoothed by the large inertia of the rotor. The average torque is practically constant, i.e. independent of the speed of operation. That is why a piston pump is often referred to as a "constant torque load".

Two types of efficiencies are distinguished for piston pumps:

$\eta_{\text{mech}}$  **Mechanical efficiency**, which is the ratio of hydraulic power output (see Chapter 1) to mechanical power input to the pump. This efficiency is less than 100%, because energy is lost due to flow resistance in the valves and pipes, and in mechanical friction of the cup leather against the cylinder and that of the pump rod sealing. High efficiencies (80% to 90%) are attained for high head pumps (i.e. more than 20 or 30 m), for which the pressure loss due to flow resistance is small in comparison with the static pressure. For low heads (3 to 10 m) the efficiency is far less (60% to 70%), pressure losses being relatively more important. Piston pumps are not very well suited for heads of less than 3 m, because of the low efficiency (losses are in a first approximation inversely proportional to head).

A low mechanical pump efficiency implies that a relatively large rotor is needed to meet specific pumping requirements. As rotor size is a prime factor determining the (investment) costs of a wind pump, it is clear that the mechanical efficiency of the pump is important for cost effectiveness.

$\eta_{vol}$  **Volumetric efficiency.** This is the ratio of the real flow rate and the ideal flow rate which would be expected on the basis of the stroke volume of the pump and the speed of operation.

At low speeds of operation the volumetric efficiency is normally less than 100% due to water leakage over the piston or valves, and to delayed closing of the valves. At high speeds it may exceed 100% as a result of inertia effects: at the end of the upward stroke the water column has gained so much momentum that it continues moving upwards during the downward stroke.

Volumetric efficiencies at the design point are normally 80% to 98%.

A low volumetric efficiency does not necessarily imply a low mechanical efficiency. If less water is pumped than would be expected, and if at the same time less power is needed to achieve this, the mechanical efficiency remains high despite a low volumetric efficiency. With a low volumetric efficiency a larger pump (stroke volume) is needed, not a larger windmill (rotor diameter). Use of a larger pump increases costs only slightly.

The main characteristics of piston pumps are summarized in Table 2.1, which also gives the characteristics of other types of pumps suitable for use with wind machines.

Figure 2.8 shows that the use of piston pumps is limited on two sides:

- o At high power requirements (high output and/or high pumping head), the diameter of the rotor of a mechanical wind pump would become prohibitively large, too heavy and too costly. A system consisting of a wind generator coupled to an electric multistage deep well pump (for large pumping heads), or a centrifugal or screw pump (for small pumping heads) is more appropriate.

Narrow tubewells of high capacity cannot be fully exploited by piston pumps. The area to the left of the horizontal line of dashes in Figure 2.8 indicates the approximate range of application of a mechanical wind pump. Of course this line is found more to the right in Figure 2.8.b compared to Figure 2.8.a, because an 8 m mechanical wind pump delivers more power at 6 m/s than at 3 m/s.

- o At low heads the efficiency of piston pumps drops and rotary pumps such as centrifugal pumps and screw pumps should be considered. The transmission losses in these systems are rather high. On the other hand they do not load the system dynamically as a piston pump does (Figure 2.7), so cause less fatigue problems.

Air lift pumps and air displacement pumps have not been included in Figure 2.8. Because of their low efficiencies their use is restricted to situations where maintenance conditions are extremely difficult. Their reliability can be attributed to the following: few moving parts in the well, insensitive to sand and to deviations of the tubewell from the vertical.

Type	Typical pumping head	Maximum efficiency	
		Pump	Pump + transmission
Piston pump	> 20 m	> 90%	80-90%
	10 m	70-80%	60-70%
	3 m	50-60%	40-50%
	< 3 m	decreasing to zero	
Centrifugal pump	Single stage, direct drive	40-60%	30-50%
	Multistage, electric, deep well	50-60%	20-30%
Screw pump	0-3 m	60-70%	40-60%
Air lift	10-50 m	20-30% *	10% *
Air-driven displacement pump	2-50 m	40-70%	10-30% *

Table 2.1. Types of pumps suitable for application in combination with wind machines. Values with an asterisk are tentative as field data are scanty.

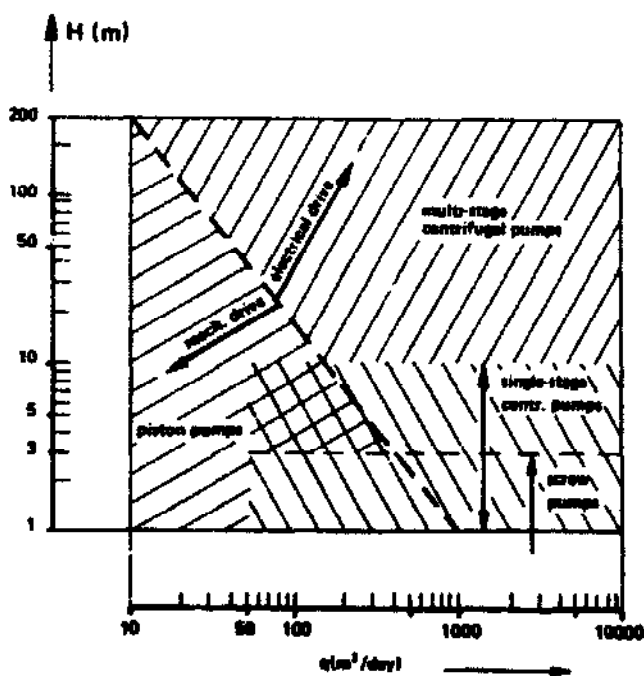

Figure 2.8a Average wind speed of 3 m/s.

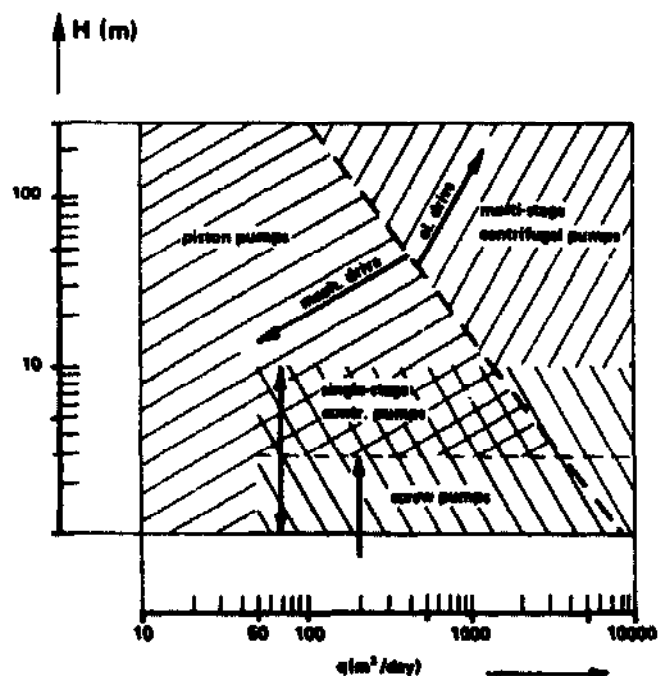

Figure 2.8b Average wind speed of 6 m/s.

Figure 2.8. Rough indication of the range of application of different pump types in combination with wind machines.

## 2.4. Matching of windmill and piston pump

The importance of proper matching of windmill and pump has already been briefly mentioned in the beginning of this chapter.

Choosing a large pump leads to a high output (volume of water pumped), but a low availability (i.e. the windmill will often stand still). The choice of a small pump improves availability but reduces output. In matching a pump to a windmill, one needs to establish the best possible compromise between output and availability.

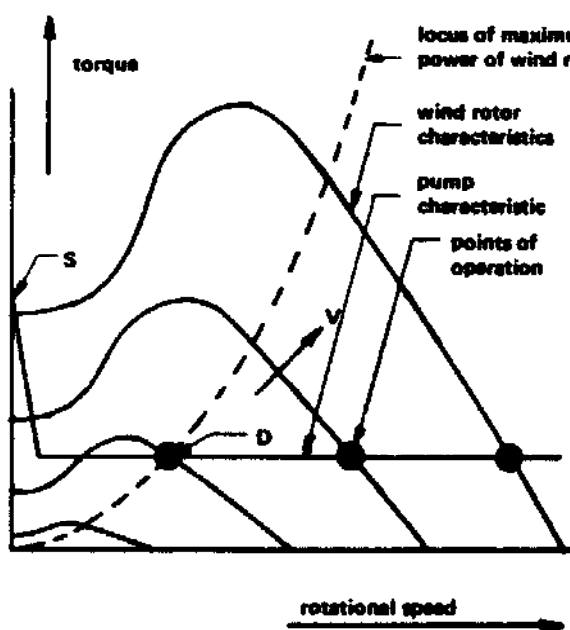

a. Torque-speed curves

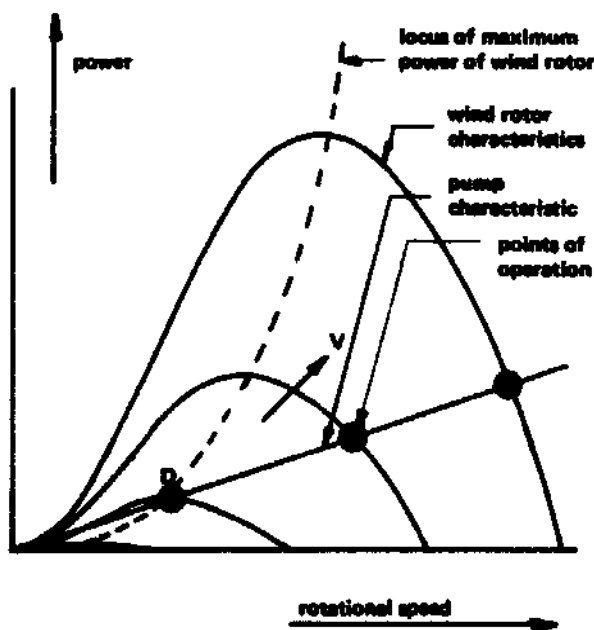

b. Power-speed curves

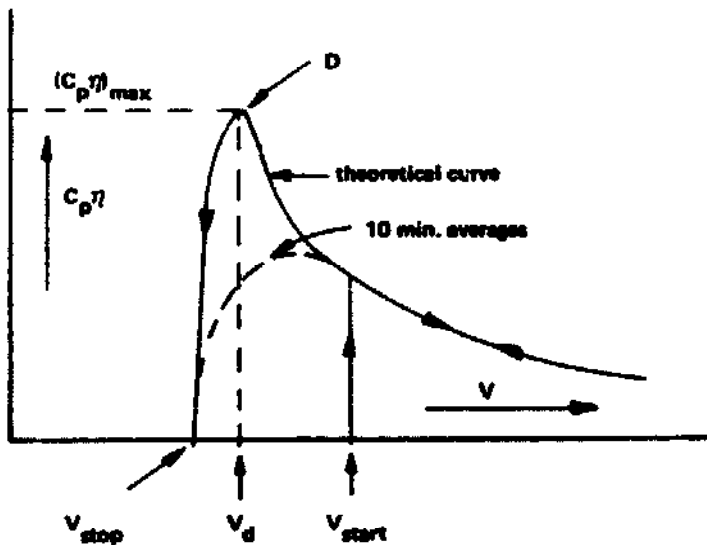

c. Overall power coefficient as a function of wind speed

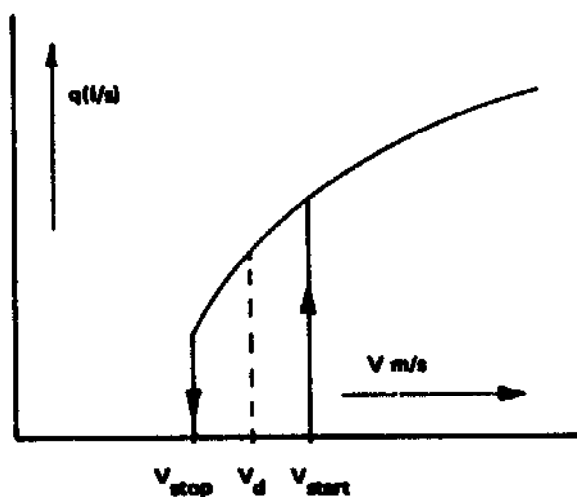

d. Start/stop behaviour

Figure 2.9. Matching of windmill and piston pumps.

The interaction of a windmill and a piston pump is illustrated in Figure 2.9.a and b. The figures indicate a set of torque-speed and power-speed curves derived from the general dimensionless curves of Figure 2.5. The dotted curves represent the locus of maximum power points of the wind rotor: a cubic curve in the power-speed diagram Figure 2.9.b, and a square curve in the torque-speed diagram, Figure 2.9.a.

Figure 2.9.a also indicates a typical pump characteristic: the (average) pump torque is constant. In the starting region the pump curve rises to  $\pi$  (3.14) times the average value since the windmill has to overcome the maximum torque for starting (see also Figure 2.7).

The windmill-pump system will operate at the points of intersection of windmill curves and pump curve, where the pump torque equals the rotor torque (or the power required by the pump equals the power delivered by the rotor). These points are indicated by dots in Figure 2.9.a and b. One sees immediately that a piston pump leaves a large part of the power available from the wind unused, especially at higher speeds. The windmill will operate at its maximum power coefficient for only one wind speed  $V_d$ , for which the pump characteristic intersects the locus of maximum power points (point D). This is illustrated once more in the diagram of overall power coefficient ( $C_P\eta$ ) versus wind speed in Figure 2.9.c. Figure 2.9.d shows the resulting water output characteristic. This coefficient ( $C_P\eta$ ) is called the overall power coefficient and includes rotor power coefficient  $C_P$ , and the efficiency of the transmission and pump. It is the ratio of hydraulic power output to wind power input at a given wind speed.

We have now identified the most important quantity governing the matching of a windmill and a piston pump:

$V_d$       Design wind speed, defined as the wind speed for which the ratio of hydraulic power output to the available wind power is maximum.

At this design wind speed the overall power coefficient is maximum; its value, as will become clear later, is one of the important parameters in describing the performance of a wind pump.

$(C_P\eta)_{\max}$       Maximum value of overall power coefficient which is attained at the design wind speed  $V_d$ .

Although this section is concerned with piston pumps, it is interesting to note that windmill systems driving rotating pumps can also be described by means of a design wind speed  $V_d$ . A similar  $(C_P\eta)-V$  curve is found as for piston pumps, but for entirely different reasons: Rotating pumps require a power input proportional to the cube of the rotational speed of the pump. Therefore, by a correct choice of the transmission ratio between rotor and pump, the wind machine of such a system can be made to operate at constant maximum power coefficient. The efficiency of the pump at constant head, however, depends strongly on the speed of operation, and reaches a sharp maximum at one speed only. Again one finds a  $(C_P\eta)$  curve similar to the one shown in Figure 2.9.

## Start and stop behaviour

A special problem of windmills driving piston pumps is starting. To start running a windmill needs a high wind speed to overcome the peak of the pump torque (point S in Figure 2.9). This wind speed is called  $V_{start}$ . It is higher than the design wind speed  $V_d$ . This problem aggravates for deep well pumps as the starting windmill has to lift not only the water column but also the weight of the pump rods.

Once the windmill is running, the rotor, thanks to its inertia, only "feels" the average torque demanded by the pump, but not the weight of the pump rod (the energy to lift the pump rod during the upward stroke is given back again during the downward stroke). In a decreasing wind a windmill keeps running well below  $V_{start}$  until it stops at  $V_{stop}$  (Figure 2.9).

**Note:**  $V_{start}$  and  $V_{stop}$  must not be confused with  $V_{cut-in}$ , as used for wind electric generators.  $V_{start}$  and  $V_{stop}$  describe a range of wind speeds within which a wind pump may pump or may not pump, depending upon whether the wind speed is increasing or decreasing.

Classical "American" windmills normally have a relatively low design wind speed  $V_d$  so as to obtain a good starting behaviour, thereby sacrificing some of the output.

A first step to improve starting behaviour is to balance the pump rod weight, permitting a larger pump to be installed without making starting more difficult. This is applied by some manufacturers.

The next step is to incorporate mechanisms for easy starting:

- o **Variable stroke mechanism.** A mechanism is incorporated which automatically adjusts the stroke. The system is allowed to start at small or zero stroke, demanding little torque. At higher speeds the stroke is increased, thereby increasing torque and water output. In this way the locus of maximum power points (Figure 2.9) can be followed much more closely. A major drawback for application of this system in developing countries is its complexity and high cost.
- o **A starting nozzle in the piston.** At low speeds all water displaced by the piston leaks through the nozzle, hardly requiring any starting torque. At higher speeds a pressure difference is built up over the nozzle and the pump effectively starts pumping. Some water is lost, but this is more than compensated for, since a larger pump can be used.
- o **Controlled valve.** At low speeds the piston valve is kept well open and starting is easy. At higher speeds the valve is closed and water is pumped. Energy loss is far less than in the case of a starting nozzle. This principle is being applied with the aid of a so-called "floating valve" which is lighter than water. Experimental results are promising (reference 31).

CHOICE OF DESIGN WIND SPEED $V_d$ ENERGY PRODUCTION COEFFICIENT $C_E$ OUTPUT AVAILABILITY			
	$V_d/V$	$C_E$	Output availability
<b>Windmills driving piston pumps</b> - Classical deep well - Classical shallow well or deep well with balanced pump rod - Starting nozzle and balanced - Ideal (future)	0.6	0.40	60%
	0.7	0.55	60%
	1.0	0.90	50%
	1.3	1.20	50%
<b>Wind machines driving rotating pumps</b>	1.2	0.90	50%

PEAK OVERALL POWER COEFFICIENT $(C_p \eta)_{max}$				
Pumping head:	$H < 3$ m	$H = 3$ m	$H = 10$ m	$H > 20$ m
<b>Windmills driving piston pumps</b> - Classical - Starting nozzle	0 to 0.15	0.15	0.20	0.30
	0 to 0.13	0.13	0.18	0.27
<b>Wind machines driving rotating pumps</b> - Mechanical transmission - Electric transmission		0.15 to 0.25 0.05 to 0.10		

QUALITY FACTOR	$\beta = P/AV^3$	$\beta = \frac{1}{2} \rho (C_p \eta)_{max} C_E$
Low 0.05	Medium 0.10	High 0.15

Table 2.2. Representative values of design and performance characteristics for wind pump systems, based on presently available information.



## 2.5. Performance of wind pump systems

As indicated in the beginning of this chapter, the main emphasis of this handbook is on windmills driving piston pumps. As has been explained in the previous section, the two main types are classical and modern wind pumps. They can be distinguished as follows:

- o Classical windmills typically have a heavy multi-bladed rotor and low speed of operation. The smaller sizes incorporate a gear box. They have a simple reciprocating piston pump. In some cases the pumprod weight can be balanced.
- o Modern wind pumps are more varied, including one or more of the following innovations: lighter construction, higher speed of operation, starting helps such as a starting nozzle, balanced pumprod, no gearing, etc.

In this section, information on performance will be given for:

- Classical wind pumps for deep well applications.
- Classical wind pumps for shallow wells, or (which is equivalent) for deep well with balanced pumprod.
- Wind pumps equipped with a starting nozzle and a balanced pumprod, which can be considered as a reasonable "modern" design.
- An "ideal" windmill that incorporates high efficiencies of rotor and pump, starting gadgets without energy loss and correct balancing of the pumprod weight. The latter is an optimum design that should be attainable for modern design wind pumps.

Besides the performance of windmills driving piston pumps, an indication is given for other types of pumps, i.e., rotating pumps with either mechanical or electrical transmission.

The performance of a wind pump, resulting from the matching of wind machine and pump (i.e. the choice of  $V_d$ ) can be summarized by two characteristic quantities, related to output and availability:

$$C_E = \frac{E}{\frac{1}{2} \rho V^3 A (C_P \eta)_{\max} T}$$

**Energy production coefficient**, defined as the real hydraulic energy production in a period  $T$ , divided by a reference energy which would be obtained in a constant wind equal to the average wind speed assuming that the wind machine is operating at maximum power coefficient during the whole period  $T$ . This coefficient depends strongly on the type of wind pump and the choice of  $V_d$ . (Note that  $E/T$  equals the average power  $\bar{P}$ ). For symbols see Section 2.2.2. Add  $T$  for time ( $s$ )).

**Output availability <sup>1</sup>**

**Output availability** is defined as the percentage of time during which sufficient wind is available to operate the wind pump at more than 10% of its average pumping rate. Again, this quantity depends strongly on the type of wind pump and the choice of  $V_d$ .

Table 2.2 presents typical values that are realized in practice for these two quantities, if the design wind speed in relation to the average wind speed is chosen according to the values indicated in the table. The values indicated in the table are based on an unavoidable compromise between output and output availability. For wind pumps with starting nozzle and balanced pumprod, one may enhance the output by choosing a higher design wind speed without affecting the starting behaviour (and hence output availability) too much. The values are also based on what is observed in practice. These values are further supported by a theoretical model presented in Appendix B.

As can be seen in the definition of the energy production coefficient above, one also needs to know the maximum overall power coefficient. Table 2.2 presents some typical values for different systems and different pumping heights. Also the density of the air has its influence (Section 3.2, Chapter 3). The effect of these three factors may be summarized by defining the quality factor  $\beta$  as a yardstick of the quality of the overall performance of a wind pump.

$$\beta = \frac{P}{A V^3} = \frac{1}{2} \rho (C_{P\eta})_{\max} C_E \quad \text{Quality factor. Typical values are indicated in Table 2.2, taking } \rho = 1.2 \text{ kg/m}^3$$

Note that the chart of Figure 1.6 was drawn, based on a value for the quality factor  $\beta$  of 0.1 (medium).

**Example:** Suppose the pumping head is  $H = 30$  m.

Using a classical wind pump,  $V_d/V$  is chosen to be 0.6, then the energy production coefficient is 0.40. The peak overall coefficient  $(C_{P\eta})_{\max} = 0.30$ . Assuming  $\rho = 1.2 \text{ kg/m}^3$ , then the quality factor  $\beta = 0.6 \times 0.3 \times 0.4 = 0.072$ , a value between "low" and "medium".

If on the other hand we were to use a rotating centrifugal pump with an electric transmission, then  $C_E = 0.80$  and with  $(C_{P\eta})_{\max} = 0.1$ , then  $\beta = 0.6 \times 0.1 \times 0.1 = 0.05$ , thus a low value of  $\beta$ .

It should be noted that the values given in Table 2.2 serve as a first approximation. Not only are experimental data insufficient, but also there may be differences between windmills in the same class of, say "classical wind pumps". Also the distribution of wind speeds at two sites with identical average wind speeds may differ. Such factors have their effect on the resulting  $\beta$ -values.

---

<sup>1</sup> The output availability should not be confused with what might be called **technical availability** (i.e. the percentage of time that the windmill is fully operational to pump water if sufficient wind is available).

From the fact that classical wind pumps have a lower energy production than modern wind pumps, one may not directly conclude that the modern pumps are always more attractive. The proven reliability of classical wind pumps can be of great importance especially for pumping from deep wells. Also the range of classical wind pumps available on the market is very wide.

## 2.6. Storage and distribution

An important part of pumping systems is the storage and distribution of water.

The efficiency of storage and distribution (i.e. the proportion of pumped water which actually reaches its point of use) has its effect on the size of the pumping system. High efficiency storage and distribution allow smaller pumping systems to be used.

The static head of the storage tank and the pressure losses in the distribution system determine the pressure for which the pump must be designed.

### 2.6.1. Storage of water

Generally speaking, the objective of a storage tank is twofold:

- o Matching the diurnal pattern of pumping and demand. A wind pump typically delivers an irregular modest flow rate throughout the day (and the night), whereas water is normally needed at a relatively high flow rate during short periods of the day.
- o Storage of surplus water during days of strong wind for later use when there is less wind.

A variety of tanks is used in combination with windmills (Figure 2.10). The type of tank which is most suited depends on the local circumstances and the application. In regions having an impermeable soil, it is often possible to construct very simple and cheap earth bund tanks. If high pressure is needed in the delivery system, an overhead tank will be necessary. Needless to say, this can enhance the cost considerably.

The most important characteristic of a storage tank is its capacity, expressed in  $m^3$  or number of days of storage. Common sizes are 20 to 200  $m^3$ , or 0.5 to 2 days. Storage for more than a few days' production is in most cases too expensive to be considered.

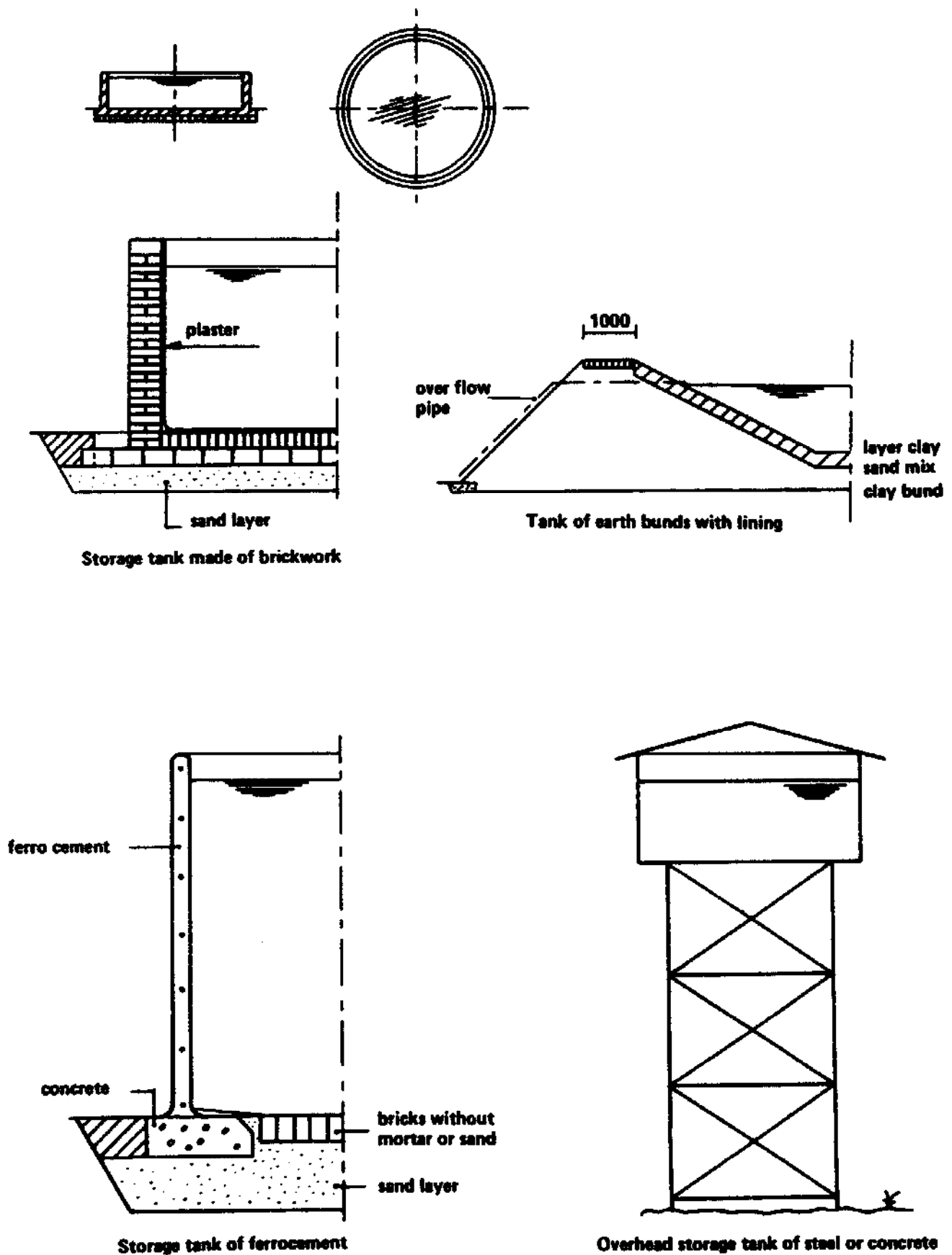

Figure 2.10. Storage tanks: principles of construction.

### **Storage for rural water supply**

In water supply systems for human consumption, storage tanks are usually used, even in combination with engine-driven pumps. In the case of engine-driven pumps, the tank stores the water which is pumped in a short period at a high flow rate for use over a longer period. It pressurizes the distribution system and forms an emergency stock of water.

For a wind pump, normally a larger storage capacity is needed to cover 1 to 2 days of demand. Usually some pressure is needed in the distribution system; therefore overhead tanks are used, or tanks of a cheaper construction at a sufficiently high point in the landscape. Tanks storing water for human consumption should always be covered to minimize pollution by dirt, insects and animals, and to prevent algae growth (by shading the water from the sunlight).

### **Storage for irrigation**

In irrigation schemes, based on engine-driven pumps, no water storage tanks are used. The water is pumped directly into the irrigation system, be it canals or pipes.

With windmills tanks are normally needed, except in cases such as:

- Paddy rice cultivation, when the field can be used for storage.
- If an engine-driven pump is used as a backup.

The main function of a storage tank in windmill irrigation is water management control. It stores the water which is pumped during periods when it is not immediately used, especially during the night. It allows the farmer to irrigate during short periods at a high, constant flow rate.

When using a wind pump for irrigation, it is essential to minimize the cost of the tank, since the cost of the water would otherwise become too high to justify its use for irrigation. Capacities of 1/2 day to 2 days are usual. Cheap earth bund tanks are preferred (Figure 2.10). Overhead storage tanks are prohibitively expensive for this application, hence irrigation systems requiring a high pressure (such as sprinklers) are normally not feasible.

## 2.6.2. Distribution<sup>1</sup>

### Rural water supply

A prime factor to consider when deciding on a distribution system for livestock or for a village water supply is the number of livestock or people to be supplied by one pump.

A village water supply needs to be designed to suit the residents of the village. There are several factors affecting rural water use habits, all of which should be taken into account when designing a water supply system. For example the time required for collecting water should be considered when choosing both the number of water points and the distance between them. Also the location of taps should be accessible for all village members. Rural water supply is treated extensively in references 11 and 12.

### Irrigation

The supply system for a small-scale irrigation scheme consists of two parts: a water distribution network to transfer water from the pump (or storage tank) to the field, and a field application system to apply water to the crops. The suitability for use with a wind pump of each of the four main methods of field application is considered in Table 2.3.

**Furrow irrigation:** With furrow irrigation the distribution system normally consists of open channels. Losses are due to evaporation (usually small, around 1%), seepage and evapotranspiration from weeds in the channels (can be high in earthen channels, 30% to 50%). The additional head due to a conveyance channel depends on the slope and channel length. The field application method will normally be furrows. Losses of irrigation water from the furrows occur due to surface run-off and deep percolation. An application efficiency of 50% - 60% is typical.

**Basin irrigation:** Here the distribution network will also be in open channels. The field is divided into small leveled basins surrounded by earthen banks (levees, ridges, bunds or dikes) up to 30 to 50 cm high around each unit. The size of the basins depends on the rate of water supply available and the rate of water infiltration into the soil. Overall field application efficiencies with lined channels, use of a storage tank and relatively small basins are usually about 60% to 80%.

**Trickle irrigation:** For this method water is conveyed in a main pipe and applied to the crop continuously with narrow perforated trickle tubes. High field application efficiencies are possible of around 85%. The head loss in the pipes is dependent on the water supply flow rate, the diameter and the total length of the pipes. Unless the area to be irrigated is level, the operating pressure has to be comparatively high to ensure an even water distribution, making the method less attractive for use with wind pumps.

---

<sup>1</sup> This section is more or less identical to the corresponding section of reference 1, with slight modifications.

**Sprinkler irrigation:** The field application efficiency of sprinkler irrigation is typically about 60% to 80%. The area watered by a given sprinkler depends on the operating pressure. For a diameter of coverage between 6 m and 35 m the sprinkler operating pressure is usually between 1 and 5 bar (low pressure sprinklers: 0.5 - 2 bar; medium pressure sprinklers: 2 - 5 bar), representing an additional head of 5 - 50 meters. Medium-pressure sprinklers are the most widely used. However, these are not an energy efficient way of irrigation and consequently not to be recommended for wind pumps. From a technical point of view it might be possible to use low-pressure sprinklers.

Field application method	Field application efficiency	Typical head	Suitability for use with wind pumps
Furrows	50 - 60%	0.5 - 1 m	yes
Basin	60 - 80%	0.5 - 1 m	yes
Trickle	85%	5 - 10 m	doubtful
Sprinkler: - low pressure - medium pressure	60 - 80%	5 - 20 m 20 - 50 m	doubtful no

**Table 2.3. Suitability of major irrigation methods for use with wind pumps.**

## 2.7. Which windmill should you choose?

There exists quite a variety of different wind pumping systems. The main differences between them concern the rotor, transmission, safety system and the pump. Figure 2.8. gives a rough indication of the type of system that might fulfil a given requirement. For the important range of application involving rotors up to 8 m diameter, the mechanical wind pump driving a piston pump is in general the most versatile solution. This fact is demonstrated by the existing market for commercial multibladed windmills which have been used for water pumping for decades.

The overall efficiency of a system depends on the total design concept, which is summarized in Table 2.2. The same table shows that innovative designs (including starting gadgets, etc.) have significant higher overall efficiencies, implying that a much smaller and less expensive wind pump is needed to fulfil the water requirements. Besides this better performance the specific weight of modern designs is lower and their relative simplicity of construction makes them potentially more appropriate for local manufacture and easier to maintain.

It should be noted, however, that the reliability of classical wind pumps is extremely good and field experience with this type of machine runs over decades. In contrast, the experience with innovative designs is short, their development ongoing and it will need more years of field experience to enhance their reliability.

## Chapter 3

### WIND PUMP SIZING

This chapter describes the steps that must be taken to determine the optimum size of wind pump to be used at a particular site and for a particular purpose. After following these steps, one should be able to answer the question "What type and size of wind pump is needed to fulfil the pumping requirements at this site?" Once the type of pump to use has been selected and its size determined, one can then consider what size of alternative pump would be needed to supply water at the same site (Chapter 4) and make an economic comparison between wind pumps and alternative pumping technologies (Chapter 5).

The steps to be followed in selecting the optimum size of wind pump for a site are:

- Assess water requirements
- Determine hydraulic power requirements
- Determine the available wind power resources
- Identify the design month
- Size the main components of the pump.

These steps are indicated on the left side of the decision chart in Figure 3.1. The same steps are described in Chapter 4 for sizing alternative pumping systems. The economic/financial steps shown on the right hand side of the chart are described in Chapter 5, which covers the financial analysis of pumping systems.

Each of the steps needed to size a wind pump is treated in a separate chapter section. Section 3.1 covers the assessment of water requirements. Section 3.2 gives formulas for calculating the hydraulic power requirements. Section 3.3 describes a method for determining the available wind power resources. Section 3.4 presents a procedure for determining the design month. Section 3.5 describes the factors that must be considered in choosing a wind pump and gives procedures for determining wind pump size. Section 3.6, which deals with preparation of specifications, is included in the chapter because technical specifications of system performance must be completed before one can undertake the financial analysis described in Chapter 5.

For each section of the chapter, a standard format sheet is provided that can be used for entering data and making the necessary calculations. These sheets have already been filled out for an example system (Flamengos, Cape Verde), where the classical wind pump (with a mechanically driven piston pump), the type of wind pump most commonly used today, was selected. The sizing methodology used for the classical wind pump may be used for all types of wind pumps to determine the diameter of their wind rotor. Examples of other wind pump installations, using various different types of pumps, are given in Appendix D. Blank format sheets are included in Appendix E.



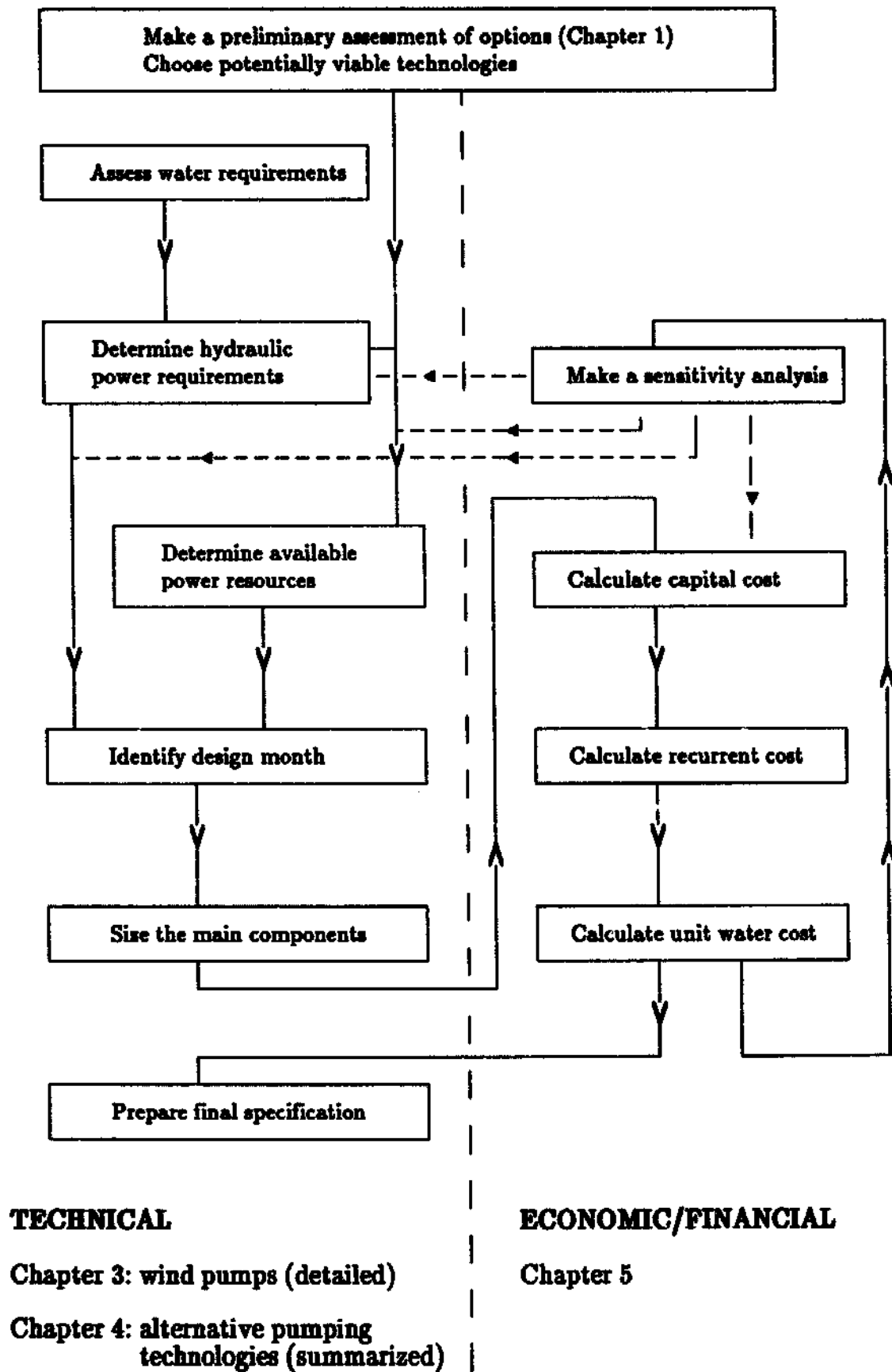

Figure 3.1. Steps to be taken for evaluation and design of pumping installations.

In selecting a pump size, one important consideration is the water output of the system. Recently an output prediction model has been developed, which is described in Appendix B. The simplified sizing system presented in this chapter is based on that model, and should be sufficient for most purposes. For special purposes, one may want to apply the more complete sizing method of Appendix B.

<b>Location</b>	Flamengos, Republic of Cape Verde Valley at north-east side of the island of Santiago
<b>Application</b>	Drinking water supply to village situated on the slopes of the valley
<b>Consumption</b>	15 m <sup>3</sup> /day throughout the year
<b>Water source</b>	Tube well of 70 m depth, situated at the valley floor Static water level (i.e. level when not pumping): 4 m below ground level (valley floor) Dynamic level (i.e. level when pumping): approximately 10 m below ground level
<b>Storage tank</b>	To be constructed on the slopes Height above valley floor: 12 m
<b>Pumping height</b>	22 m (dynamic level of well plus height of storage tank above valley floor)
<b>Wind situation</b>	The well site is well exposed to the north-east, the prevailing wind direction, coinciding with that of the valley. The only obstacles are the crops, with heights less than 2 m. The wind speed was estimated to be 0.7 times the wind speed at the airport of Praia for which data are available.

Table 3.1. Specification of example site (reference 24).

### 3.1. Assessing water requirements :

Before one can determine the hydraulic power requirements of a pumping system, one must know what the water is to be used for, whether for irrigation, rural water supply, or other uses. One can then make an estimate of the water requirements for that application. This section looks at the water requirements for irrigation and for rural water supply.

#### 3.1.1. Irrigation

The amount of water needed to irrigate a given area depends on a number of factors. The most important of these are:

- Nature of crop, crop growth cycle
- Climatic conditions
- Type and condition of soil
- Topography of the terrain
- Conveyance efficiency
- Field application efficiency
- Water quality

All of these factors need to be taken into account in the design of a small wind pump installation for irrigation. Any one of them can have a large influence on the amount of water needed. Some of them vary with the seasons, so that the quantity of water required will change over a period of time.

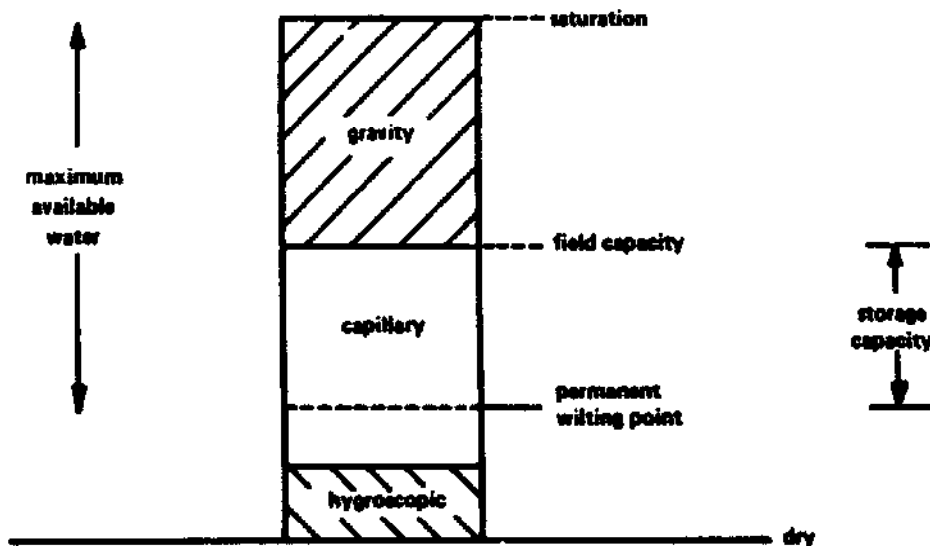

Figure 3.2.a. Soil moisture quantities (reference 1).

<sup>1</sup> This section of the wind pump handbook is largely identical to the corresponding section in the solar handbook (reference 1). The subject matter is not specific to the energy source used.

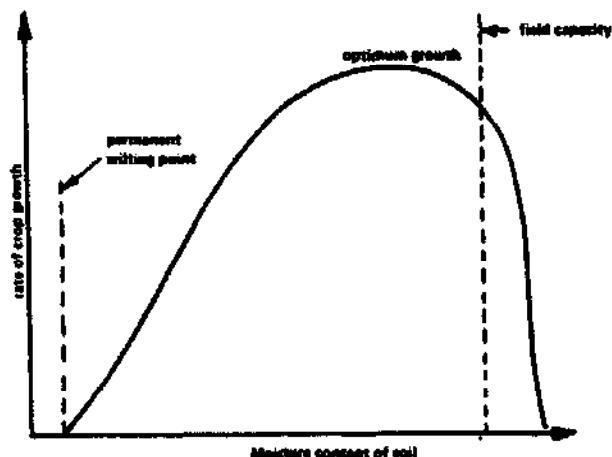

Figure 3.2.b.

Rate of crop growth as a function of soil moisture content (reference 1).

The crop takes its water requirements from moisture held in the soil. Useful water for the crop varies between two levels: the "permanent wilting point" and "field capacity" (see Figure 3.2.a). Water held by the soil between these two levels acts as a store. When this store approaches its lowest level, the crop will die unless additional water is supplied.

The rate of crop growth depends on the moisture content of the soil. There is an optimum growth rate condition in which the soil water content lies at a point somewhere between the field capacity and the permanent wilting point (Figure 3.2b). However, this point varies for different crops and for different stages of growth. It is not easy to adjust the irrigation intervals so that there is optimum crop growth.

An estimate of the quantity of water required for irrigation can usually be obtained from local experts, preferably agronomists. It involves three major stages (for full details see reference 9):

- o Crop water requirements are estimated, using prediction methods, because of the difficulty of obtaining accurate field measurements.
- o The effective rainfall and groundwater contributions to the crop are subtracted from the crop water requirements to give the net irrigation requirements.

Month	Bangladesh: April to July : rice Oct. to April: vegetables (m <sup>3</sup> per day per hectare)	Thailand Jan. to Dec.: sugar cane (m <sup>3</sup> per day per hectare)
January	7.1	1.3
February	17.5	27
March	28.4	32
April	85.0	42
May	- )	42
June	- )	31
July	- ) rainy	28
August	- ) season	22
September	- )	12
October	- )	-
November	15.0	-
December	16.5	21

Table 3.2. Typical net irrigation water requirements for Bangladesh and Thailand (reference 1).

- o Field application and water conveyance efficiency are taken into account to give the gross pumped water requirements.

To illustrate the diversity in irrigation water requirements between different crops and different locations, Table 3.2 gives water requirements for different crops in Bangladesh and Thailand.

It must be stressed that the assessment of water requirements for a farm under windmill irrigation is less straightforward than for an engine-driven pump. The output of a wind pump cannot be controlled at will, and one will have periods with excess water and other periods with lack of water. In some exceptional cases farmers might even adapt their cropping pattern to some extent to the seasonal variations of wind pump output.

### 3.1.2. Water requirements for rural water supply

The estimate of water demand for villages and livestock is considerably easier than that for irrigation, because the volume required can be obtained by multiplying the number of people or animals by their estimated per capita consumption.

Domestic water requirements per capita vary markedly in response to the actual availability of water. If there is a home supply, consumption may be five or more times greater than if water has to be collected at a public water point.

A WHO survey in 1970 showed that the average water consumption in developing countries ranges from 35 to 90 liters per capita per day. The long-term aim of water development is to provide all people with ready access to safe water. For the near future a reasonable goal to aim for would be a water consumption of about 40 liters per capita per day. Thus for typical village populations of 500, water supplies will have to be sized to provide about 20 m<sup>3</sup> per day.

In order to limit the time spent on collecting and carrying water, a single pump or water point should usually supply no more than about 500 people.

To prevent overgrazing in the vicinity of water points, their capacity should be kept reasonably small.

Table 3.3 shows typical daily water requirements for a range of livestock.

Species	Litres of water/head
Camels	40 - 90
Horses	30 - 40
Cattle	20 - 40
Milk cow in production	70 - 100
Sheep and goats	1 - 5
Swine	3 - 6
Lactating sow	25
Poultry	0.2 - 0.3

Table 3.3. Typical daily water requirements for livestock, reference 34.

### 3.2 Calculating the hydraulic power requirements

Once the water requirements are known, the hydraulic power requirements can be determined, using the equation 1.1.c, or the equivalent nomogram of Figure 4.1.

$$P = 0.113 \times q \times H$$

P	average power	(W)
q	pumping rate	(m <sup>3</sup> /day)
H	total head	(m)

The total head includes:

- Pumping height:
  - . Static water level of the water source below ground level.
  - . Drawdown of the water source i.e. the lowering of the water level due to pumping.
  - . Static lifting height above ground level, e.g. for pumping into a storage tank.
- Head losses in the piping (due to friction).

The pressure loss in the pipes depends on the pipe diameter and the flow rate as shown in Figure 3.6. For wind pumps the pressure loss is mostly kept very small, about 5% to 10% of the total head. After sizing the piping (see below), one needs to verify this assumption, especially at low heads and in the case of long lines.

Table 3.4 gives a format sheet for estimating the average hydraulic power requirements. It has been completed for the example system (at Flamengos, Cape Verde), assuming a 10% head loss in the pipes.



*In designing the system head losses in the piping (due to friction) should be taken into consideration.*

In the example the static head is assumed to be constant throughout the year. However, where there are variations due to drawdown, monthly mean values of the static head should be used. In the example, the pumping requirement is constant. However, especially in case of irrigation, the requirements will vary with seasons, and monthly mean values must be used (see example in Appendix D).

HYDRAULIC POWER REQUIREMENTS					
Location. <i>FLAMENGOS, CAPE VERDE</i> .....					
Delivery pipe head loss. <i>10</i> ...%			Delivery pipe length. <i>50</i> ...m		
Month	Pumping requirement (m <sup>3</sup> /day)	Pumping height (m)	Head loss (m)	Total head (m)	Average hydraulic power requirement (W)
Jan	<i>15</i>	<i>22</i>	<i>2</i>	<i>24</i>	<i>41</i>
Feb	<i>15</i>	<i>22</i>	<i>2</i>	<i>24</i>	<i>41</i>
March	<i>15</i>	<i>22</i>	<i>2</i>	<i>24</i>	<i>41</i>
April	<i>15</i>	<i>22</i>	<i>2</i>	<i>24</i>	<i>41</i>
May	<i>15</i>	<i>22</i>	<i>2</i>	<i>24</i>	<i>41</i>
June	<i>15</i>	<i>22</i>	<i>2</i>	<i>24</i>	<i>41</i>
July	<i>15</i>	<i>22</i>	<i>2</i>	<i>24</i>	<i>41</i>
Aug	<i>15</i>	<i>22</i>	<i>2</i>	<i>24</i>	<i>41</i>
Sept	<i>15</i>	<i>22</i>	<i>2</i>	<i>24</i>	<i>41</i>
Oct	<i>15</i>	<i>22</i>	<i>2</i>	<i>24</i>	<i>41</i>
Nov	<i>15</i>	<i>22</i>	<i>2</i>	<i>24</i>	<i>41</i>
Dec	<i>15</i>	<i>22</i>	<i>2</i>	<i>24</i>	<i>41</i>
Total yearly water requirement <i>5475</i> m <sup>3</sup> /year					

Table 3.4. Format sheet for assessment of hydraulic power requirements.

### 3.3 Determining the available wind power resources

Month by month wind data are required, in order to assess adequately the suitability of a location for wind pumps. It is not sufficient to size a wind pump on the basis of annual wind power resources because a pump sized in this way may not provide sufficient water in months of low wind speeds.

If wind speeds have been measured at the site at the correct height, the results of the measurements may be used directly in the second column of the format sheet, shown in Table 3.5. However, this is seldom the case, and one has to rely on data from nearby meteorological stations and other available information. Unfortunately, no simple straightforward procedure can be given to obtain the desired results: monthly average wind speeds at the anticipated hub height of the wind pump.

WIND POWER RESOURCES				
Location. <i>FLAMENGOS</i> ..... Height above sea level. <i>4100</i> ..... m <i>CAPE VERDE</i> .....				
Hub height. .... <i>12</i> ..... m Terrain roughness. .... <i>0.10</i> .....				
Combined correction factor for hub height and roughness. <i>0.98</i> ...				
Month	Average potential wind speed at 10 m (m/s)	Average wind speed at hub height (m/s)	Density of air (kg/m <sup>3</sup> )	Specific wind power (W/m <sup>2</sup> )
Jan	<i>5.0</i>	<i>4.9</i>	<i>1.2</i>	<i>71</i>
Feb	<i>5.5</i>	<i>5.4</i>	<i>1.2</i>	<i>94</i>
March	<i>5.5</i>	<i>5.4</i>	<i>1.2</i>	<i>94</i>
April	<i>5.2</i>	<i>5.1</i>	<i>1.2</i>	<i>80</i>
May	<i>5.6</i>	<i>5.5</i>	<i>1.2</i>	<i>100</i>
June	<i>4.7</i>	<i>4.6</i>	<i>1.2</i>	<i>58</i>
July	<i>3.6</i>	<i>3.5</i>	<i>1.2</i>	<i>26</i>
Aug	<i>3.4</i>	<i>3.3</i>	<i>1.2</i>	<i>22</i>
Sept	<i>3.6</i>	<i>3.5</i>	<i>1.2</i>	<i>26</i>
Oct	<i>4.5</i>	<i>4.4</i>	<i>1.2</i>	<i>51</i>
Nov	<i>4.5</i>	<i>4.4</i>	<i>1.2</i>	<i>51</i>
Dec	<i>5.0</i>	<i>4.9</i>	<i>1.2</i>	<i>71</i>

Table 3.5. Format sheet for assessment of wind power resources.



As indicated in Chapter 1, the assessment of wind resources is complex and uncertain, due to large variations in wind resources from one time to another and from one location to another. Also the conversion of data of a nearby meteorological station into site-specific data is quite complicated.

In general the assessment of wind energy resources is not an easy job and it is worthwhile consulting an expert if one is available. The necessary steps for an assessment, which are discussed in more detail in Appendix A, are summarized here:

- Interpretation of data of meteorological service.
- Correction and conversion of data to so-called potential wind speed, which would be observed at that location if the terrain were completely flat and open.
- Correction for the terrain characteristics of the site and the hub height of the projected wind machine to obtain the real wind speeds, at hub height.
- Assessment of the site's wind power resources.

The procedure is presented in a simplified form in the format sheet of Table 3.5. In the table a combined correction for terrain roughness and hub height is applied directly to monthly average values of the potential wind speed. In reality one would use a table showing wind speeds in different directions and would apply corrections for each wind direction. Finally one would combine the results into one monthly average.

**Note:** As well as the monthly average values one should consider the daily variations in wind speed. For example, in a situation with 6 hours of strong winds a day, and 18 hours of calm, one should design the wind pump to satisfy the daily pumping requirements during those 6 hours. It lies outside the scope of this handbook to treat this in detail.

Once the monthly average wind speed at hub height has been found, one may continue the procedure.

Subsequently one must determine the density of the air. At sea level it is about 1.2 kg/m<sup>3</sup>. At high altitudes it is considerably lower, down to 0.7 kg/m<sup>3</sup>. An air density table is included in Appendix A.

Once the average wind speed and the air density are known, one may calculate the specific wind power:

$$P_{\text{wind}} = \frac{1}{2} \rho V^3 \quad \text{with} \quad \begin{array}{ll} P_{\text{wind}} & \text{specific wind power} \quad (\text{W/m}^2) \\ V & \text{average wind speed} \quad (\text{m/s}) \\ \rho & \text{density of air} \quad (\text{kg/m}^3) \end{array}$$

The format sheet in Table 3.5 shows the results for the example system. The site of the example is practically at sea level, and the density of air is put at 1.2 kg/m<sup>3</sup>. Note the strong effect of small differences in wind speed: 3.3 m/s gives 22 W/m<sup>2</sup>, whereas 5.5 m/s gives 100 W/m<sup>2</sup>!

The data in Table 3.5 illustrate how sensitive the specific wind power (a measure of the power input to a wind pump) is to the value of the wind speed. In sizing the wind pump system and calculating unit water costs in subsequent steps, it is advisable, if there are doubts about the accuracy of the measured wind data, to perform a sensitivity analysis on the data. That is, one should go through the procedure (see Figure 3.1) a second time

using a slightly different wind speed value. As explained in Chapter 1, slight variations in wind speed can have a large influence on available wind power as the power of the wind (when the wind is blowing freely) is proportional to the wind speed cubed. So, a small error in estimating wind speed can lead to a large error in calculating available wind power resources.

DESIGN MONTH					
Location: <i>FLAMENGOS, CAPE VERDE</i> .....					
Month	Average hydraulic power $P_{hydr}$ (W)	Average wind speed at hub height (m/s)	Specific wind power $P_{wind}$ (W/m <sup>2</sup> )	Reference area $P_{hydr}/P_{wind}$ (m <sup>2</sup> )	Design month
Jan	41	4.9	71	0.6	
Feb	41	5.4	94	0.4	
March	41	5.4	94	0.4	
April	41	5.1	80	0.5	
May	41	5.5	100	0.4	
June	41	4.6	58	0.7	
July	41	3.5	26	1.6	
Aug	41	3.3	22	1.9	←
Sept	41	3.5	26	1.6	
Oct	41	4.4	51	0.8	
Nov	41	4.4	51	0.8	
Dec	41	4.9	71	0.6	

Table 3.6. Format sheet for identification of design month.

### 3.4. Determining the design month

To continue the sizing procedure, the month by month average hydraulic power requirements and wind power resources must be known.

There are two options for operating the wind pump: either as a standalone system which must be sized to provide all water, or as a fuel saver. In the latter case the wind pump provides the basic water supply, but peak demands are met by an alternative method.

The procedure for a standalone system will be given here as it can be presented in a rather straightforward manner.

**Note:** If one were to choose to operate the wind pump as a fuel saver, sizing of the pump would be an iterative process, going from sizing to economic analysis, and back to sizing again. Choosing a very large windmill which fulfils all needs would save a large amount of fuel, but is not necessarily the most economic solution: there will be periods of high wind speeds with excess of water which cannot be used, and this does not correspond to any fuel saving. For a very small windmill all output can be put to use, but the fuel saving is less than the real potential. One must find the optimal size through the iterative process.

The sizing methodology for standalone systems is based on the concept of the **critical month** or **design month**. This is the month in which the water demand is highest in relation to the wind power resources, i.e. the month when the system will be most heavily loaded. The **design month** is found by calculating the ratio of the hydraulic power requirement to the wind power resource for each month. The month in which this ratio is a maximum is the **design month**.

This ratio has the dimension of an area and will be referred to as the **reference area**. It is related to the rotor area needed to capture sufficient power. In sizing the wind pump, this **reference area** will be converted into a real rotor area by incorporating specific wind turbine parameters.

Table 3.6 presents a format sheet for identifying the design month, completed for the example. Data on hydraulic power requirements and wind power resources are taken from the previous sheets. For the example, the design month is found to be August.

WIND PUMP SYSTEM SIZING	
Location..	FLAMENGOS CAPE VERDE.....Height above sea level.4100...m
Design month...	AUGUST.....
Design month water requirements	
Pumping rate.....	15.....m <sup>3</sup> /day
Pumping height.....	24.....m
Hydraulic power requirement, $\dot{P}_{hydr}$ .....	41.....W
Design month wind power resources	
Average wind speed.....	3.3.....m/s
Air density (standard 1.2).....	1.2.....kg/m <sup>3</sup>
Specific wind power $P_{wind}$ .....	22.....W/m <sup>2</sup>
Design month reference area $\dot{P}_{hydr}/P_{wind}$ .....	1.9.....m <sup>2</sup>
Type of wind pump	<input checked="" type="radio"/> Classical deepwell <input type="radio"/> Classical shallow well, balanced pump rod <input type="radio"/> Recent design, starting nozzle, balanced pump rod
Step	Calculations
1. Tower	Height.....12.....m
2. Rotor	Energy production coefficient.....0.4 Maximum overall power coefficient.....0.3 Diameter.....4.3.....m
3. Pump	Design wind speed.....2.0.....m/s Design tip speed ratio.....1 Transmission ratio.....0.5 Stroke volume.....2.2.....l Stroke.....12" = 305.....mm Diameter.....4" = 102.....mm
4. Storage tank	Volume.....30.....m <sup>3</sup> Height.....12.....m
5. Pipe work	Diameter.....2 1/2" = 65.....mm Total length.....50.....m

Table 3.7. Format sheet for wind pump system sizing.

## **3.5. Sizing the wind pump system**

Before the size of the wind pump can be estimated one has to decide what type of wind pump will be used, e.g. classical or modern.

### **3.5.1. Considerations in choosing the type of wind pump**

Choosing the type of system that would fulfil the requirements of a customer is not easy. Table 2.1 and Figure 2.8, Chapter 2 give a rough indication of which type of wind pump suits a certain requirement. In some cases more options are feasible and these will have to be checked. One important consideration is whether or not a design is available on the market.

Supposing that (given the requirements) a mechanical wind pump driving a piston pump is the only solution. One still has to decide whether to go for a classical multibladed wind pump or one of a more modern design. Additionally, one must decide whether to import the wind pumps or to start local production.

In general — and especially for deep well pumping — the classical multibladed wind pumps are more reliable than the modern pumps of innovative designs. Field experience with classical wind pumps runs over decades, while none of the modern designs has been field tested for more than 10 years. However, maintenance of the classical windmill can be difficult if specialized spare parts have to be imported. In general the modern designs make more use of standard materials that can be obtained on the local market. In all cases a minimum requirement for proper maintenance is the availability of spare parts.

#### **Local production**

Local production, whether of the classical wind pumps or of modern wind pumps, presents many problems and should not be undertaken without careful consideration of the following:

- o Is the scope of the market expressed in the number of wind pumps that could be sold annually, large enough to justify local production? The initial costs (manpower and infrastructure) of setting up local production are high. It requires expertise (engineers, etc.), that might be used more profitably in other sectors of the economy.
- o Is local production more attractive from a financial/economical point of view than import? This depends on many factors, among others the level of wages and materials. For example, both labor and material costs (steel, etc.) are very low in Sri Lanka. Wind pumps are produced there at an extremely low investment cost of \$ 100/m<sup>2</sup> rotor area (see also Chapter 5 on Financial assessment). These conditions do not prevail in many other countries.
- o Are there sufficient production capabilities available in the country? Can manufacturers meet the required quality standards of the design?

- o The output of modern wind pumps can be substantially higher than that of classical wind pumps. This can be of paramount importance especially for irrigation: a farmer has to weigh his benefits against the costs, i.e. unit water costs.
- o If wind energy for water pumping is regarded — on the national political/economic level — as an important issue, local production and opting for modern designs could well be made part of a long-term policy.
- o If a substantial market for wind pumps exists in a country, local production of modern designs will in the long run be more profitable financially for the user and more economically advantageous for the country than importing pumps.

These remarks may serve to stress the importance of making a proper and detailed assessment of the type of windmill to be chosen and weighing the pros and cons of local production.



*Local production*

### 3.5.2. High output versus high output availability

The sizing of a wind pump system must be based on the establishment of a compromise between two conflicting demands:

- High output, i.e. a lot of water must be pumped.
- High output availability, i.e. the water must become available in a regular, continuous fashion.

The concepts of output and output availability have been defined in Section 2.4, Chapter 2. A wind pump with a large pump will lift a large amount of water, but needs more wind to get it started, and therefore often stands still. It provides high output but low output availability. A wind pump with a small pump will start easily, but pump less water. It provides a low output but has high output availability.

For the purpose of this paragraph it is assumed that a "reasonable" compromise has been chosen, according to Table 2.2. The reader who wishes to choose the compromise in a different way is referred to Appendix B, Section B.2.

Table 3.7 contains a format sheet which may be used as a guideline in the sizing procedure. In the upper half of the sheet the data pertaining to the design month must be filled in (to be derived from the three previous sheets, Tables 3.4, 3.5 and 3.6).

To perform the sizing procedure, the following information is needed:

- a. Tower height
- b. Rotor diameter
- c. Pump size
- d. Storage tank
- e. Piping

#### a. The tower height

Although the rotor diameter is the most important characteristic of a wind machine, the tower height needs to be known first so that one can calculate the wind speed at hub height (see Table 3.5). Data on monthly average wind speed at hub height is needed in order to estimate available wind power resources (Section 3.2).

The tower height should be chosen so as to raise the rotor blades well above any obstacles in the surroundings of the windmill. In the presence of trees the rotor tips should have a clearance of at least one rotor diameter over the tree tops.

The choice of the tower height is limited, as manufacturers normally supply a standard range of towers, from 10 to 15 m high. For small windmills one finds towers down to 6 m and for large windmills up to 24 m.

For the example system the standard height of 12 m was selected.

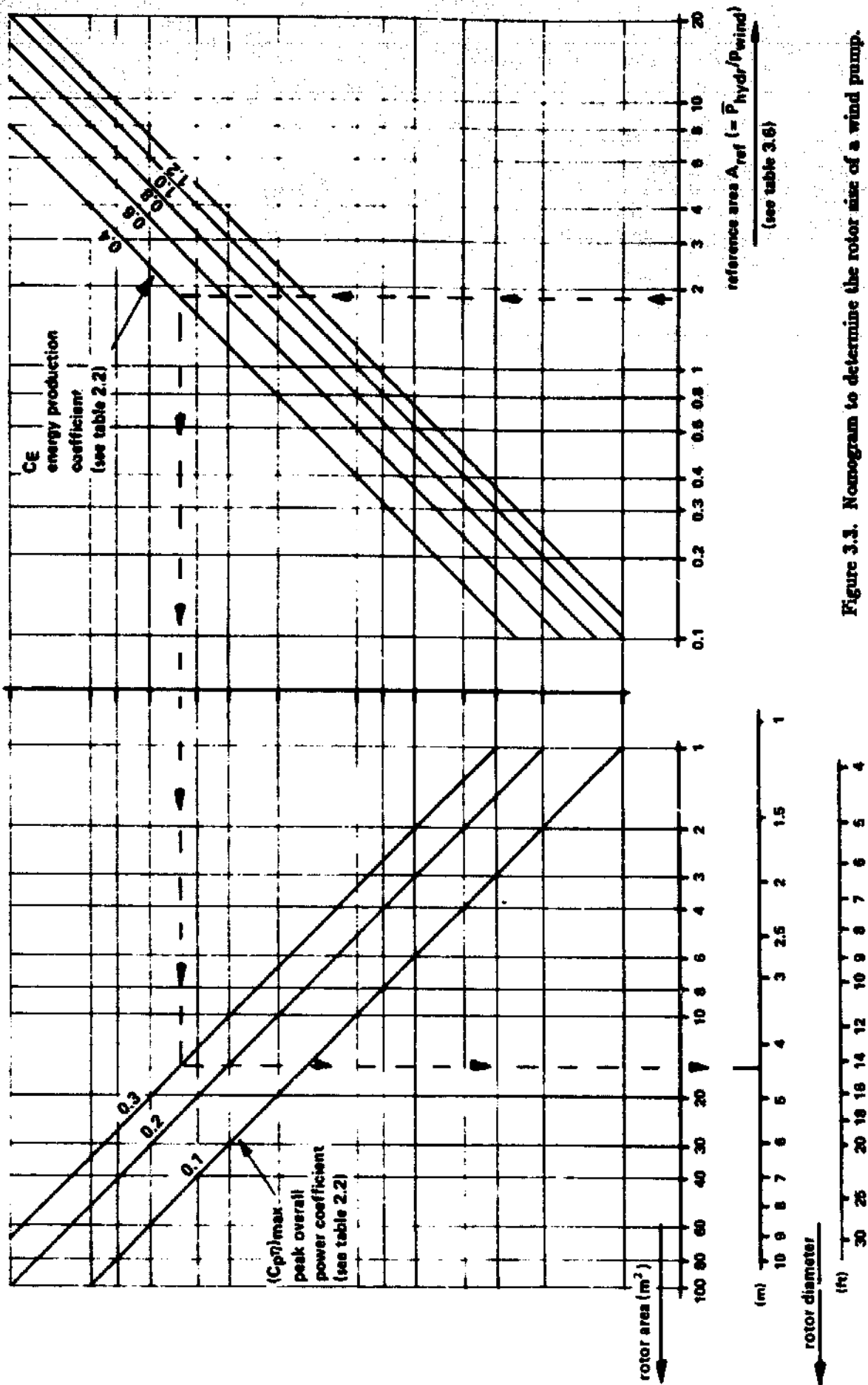

Figure 3.3. Nomogram to determine the rotor size of a wind pump.



## b. The rotor diameter

The rotor diameter is the most important characteristic of a wind pump, determining both its output and its cost.

The nomogram in Figure 3.3 may be used to determine the required rotor size as follows:

- o The starting point is the axis of the reference area, which is the ratio of average hydraulic power requirement and specific wind power. This ratio was determined in the format sheet for determining the design month (Table 3.6).

For the example system the reference area for the design month, August, was found to be  $1.9 \text{ m}^2$ .

- o The right hand part of the nomogram accounts for the energy production coefficient, which is related to the type of wind pump. Common values are indicated in Table 2.2, Chapter 2.

In the example one wishes to apply a classical multiblade wind pump. The water level is 10 m below ground level. Therefore one takes the value for "classical wind pump, deep well", and finds  $C_E = 0.40$ .

- o The left hand part of the nomogram accounts for the peak overall power coefficient, which depends mainly on the pumping height. Common values may be found in Table 2.2, Chapter 2.

In the example the pumping height is 22 m, and the wind pump is a classical wind pump. Therefore one finds  $(C_P \eta)_{\max} = 0.3$ .

- o Finally one finds the required rotor diameter. If a windmill of exactly this diameter is not available, choose the nearest standard size.

In the example system one finds a rotor diameter of 4.5 m. This is very close to one of the wind pumps of the standard range being applied: 4.3 m (14 ft.). In this case, choose the 14 feet wind pump.

**Note:** If a rotor diameter is found to be out of proportion to the tower height, reconsider the tower height and repeat the procedure.

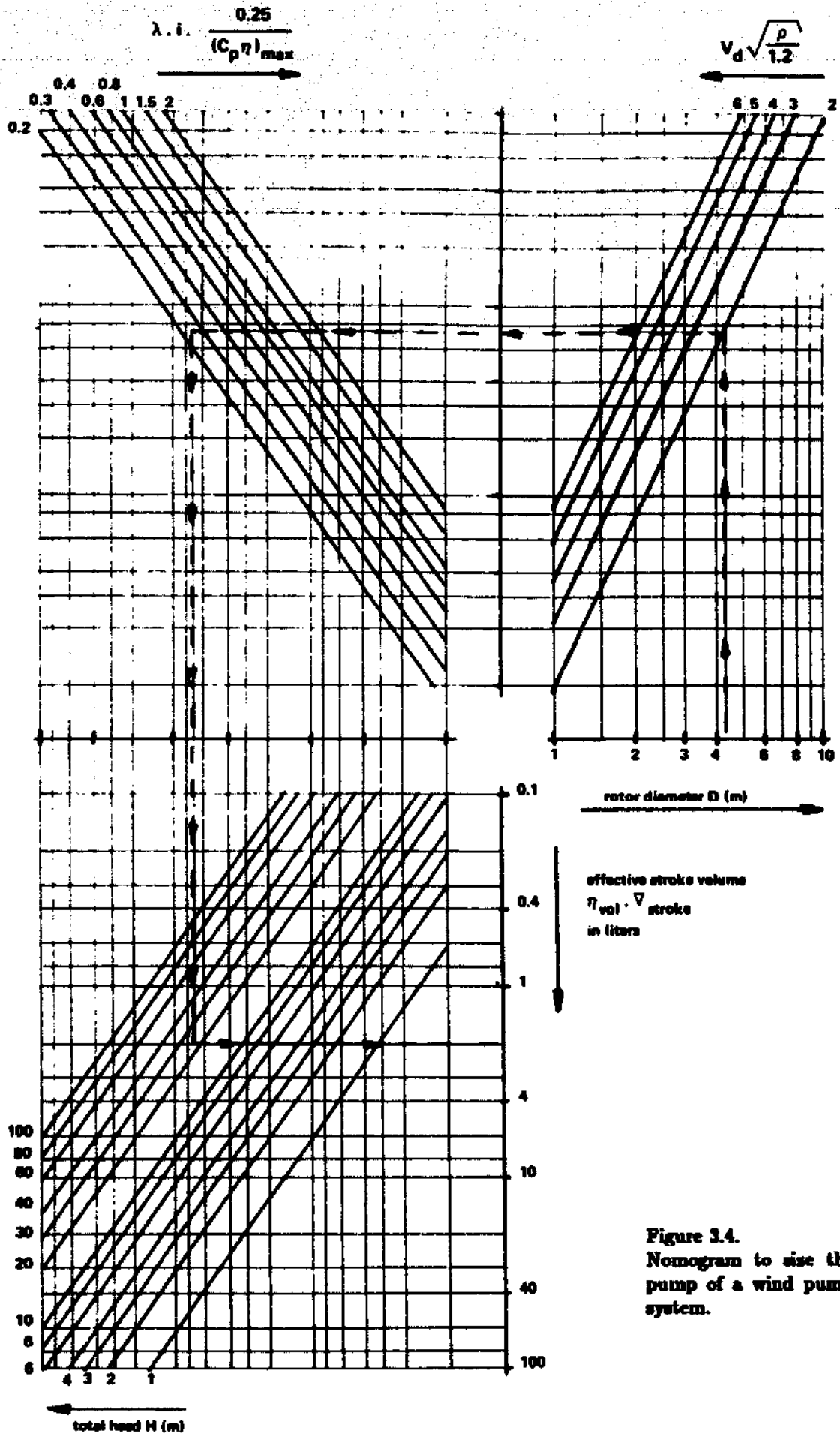

Figure 3.4.  
Nomogram to size the  
pump of a wind pump  
system.

### c. The pump size

The nomogram in Figure 3.4 may be used to determine the size of the pump, characterized by its stroke volume. The nomogram can be used as follows:

- o The starting point is the rotor diameter, the horizontal axis on the right. For the example system this is 4.3 m.
- o The design wind speed is taken into account in the upper right quadrant. In Table 2.2, Chapter 2 one finds the appropriate value of the ratio of design wind speed to average wind speed. If the density of air (indicated in the format sheet on wind power resources, Table 3.5) differs significantly from  $1.2 \text{ kg/m}^3$ , one must apply a correction as indicated in the figure: instead of  $V_d$  one should take  $V_d$  times  $\sqrt{(\rho/1.2)}$ .

For our example, a classical wind pump with deep well pump, the ratio of  $V_d/V$  given in Table 2.2 is equal to 0.6. With the average wind speed in the design month of 3.3 m/s, one finds  $V_d = 2 \text{ m/s}$ . No correction for the density of the air is needed, since it is equal to  $1.2 \text{ kg/m}^3$ .

- o The speed of operation is represented in the upper left part of the nomogram. The design tip speed ratio  $\lambda_d$  is approximately 1.0 (unity) for most classical wind pumps, and 1.5 to 2.0 for recent designs. The transmission ratio  $i$  is equal to unity for directly-driven wind pumps and around 1/3 for back-geared wind pumps. The nomogram has been drawn for a value of the peak overall power coefficient of 0.25. If it differs significantly one must apply a correction as indicated in the figure, multiplying  $(\lambda_d \cdot i)$  by  $0.25 / (C_P \eta)_{\max}$ .

In the example system, comprising a classical back-geared wind pump,  $(\lambda_d \cdot i)$  is equal to 0.3. As indicated earlier the peak overall power coefficient  $(C_P \eta)_{\max} = 0.3$ . Therefore the corrected value  $0.3 \times 0.25 / 0.3 = 0.25$  is applied.

- o The lower left part of the nomogram takes into account the total head. For the example  $H = 24 \text{ m}$ .
- o Finally, one finds on the lower vertical axis the effective stroke volume, the volume of water to be pumped in each stroke. The geometric stroke volume  $V_{\text{stroke}}$  must be slightly larger ( $V_{\text{stroke}}$  is the volume displaced by the piston in each stroke). The relation between the two is expressed in the volumetric efficiency  $\eta_{\text{vol}}$  (see Chapter 2). For the slow-running pumps of classical wind pumps it ranges from 0.9 to unity. For pumps in recent designs, especially pumps having a starting nozzle,  $\eta_{\text{vol}}$  may be lower, around 0.8.

For the example system one finds an effective stroke volume of 2.0 l. Assuming a volumetric efficiency of 90%, the geometric stroke volume is 2.2 liters.

On the basis of the stroke volume thus obtained one must select the pump diameter and the stroke. The result will depend on the stroke settings available in the windmill's transmission, and on the pump diameters available. Sometimes an important limiting factor for the pump diameter is the tubewell in which the pump has to fit.

Figure 3.5 can be helpful in selecting a combination of diameter and stroke. Note that the figure gives the internal diameter of the pump cylinder, whereas the external diameter has to fit into the tubewell.

For the example system one takes the maximum stroke available for the 14' windmill, which is 12" (or 305 mm). With a desired stroke volume of 2.2 l one finds a pump diameter of 96 mm. This is close to one of the pumps of the standard range in use: 4" (102 mm).

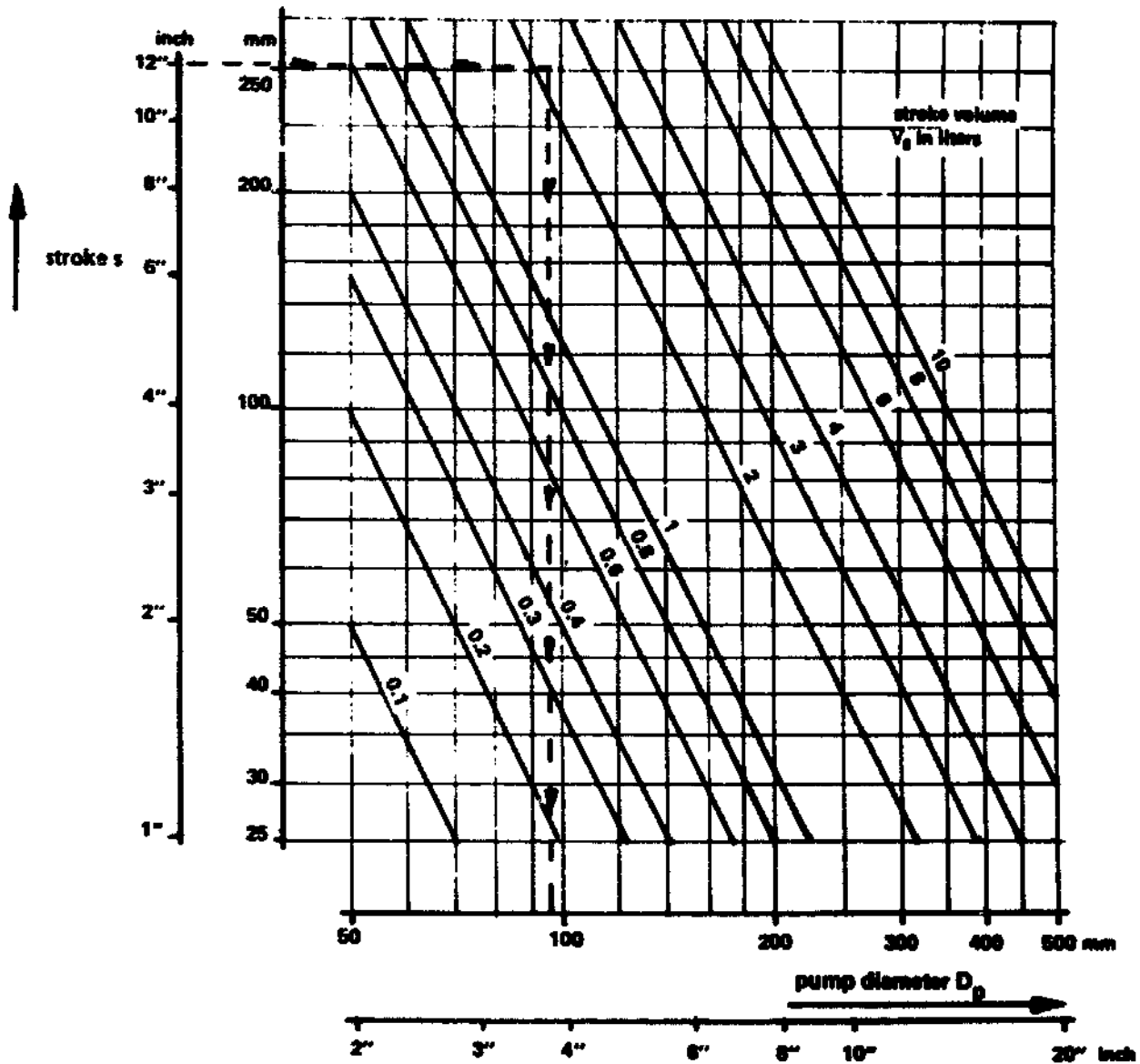

Figure 3.5. Nomogram to choose stroke and diameter of piston pump.

#### **d. The storage tank**

As outlined in Chapter 2, a storage tank is an essential part of any wind pump system. Often its cost is a substantial part of the total system cost. Therefore it needs careful consideration in the design phase.

The main characteristics to be determined are the size (volume) and the height above ground level. For the sizing procedure one needs to distinguish between application for rural water supply and for irrigation (Section 3.1).

#### **Sizing the storage for rural water supply**

Rural water supply systems usually incorporate storage tanks, even if the water is lifted by engine-driven pumps. In the case of wind pumps however, larger tanks may be required.

With engine-driven pumps, storage tanks are normally made large enough to adapt the pumping rate to the rate of consumption. During the hours of the day when people come to fetch water, the rate of consumption may be higher than the pumping rate of the pump. The storage tank should be large enough to supply this peak demand. The tank should also be large enough to guarantee some emergency supply in case the pump breaks down.

Sizing the tank of a wind pump system requires a slightly different approach. The tank should be made large enough to store all water pumped during the hours that consumption is low or zero (especially at night). In calculating this amount of water, one should take a day of relatively strong wind, hence a pumping rate above the average. A tank sized in this way should be large enough to store some water for days when the wind speed is below average.

In addition one needs to consider the duration of continuous windless periods. The tank should be made large enough to overcome these periods. It may sometimes be acceptable to reduce consumption during periods of low supply, e.g. by postponing clothes washing for one or two days. However, such a decision should only be made after careful consideration of its effects on the local population.

If one finds that a storage tank of more than two or three days capacity is required, it might be more economical to limit the size of the storage tank, and use an engine-driven pump as a back-up. Storage tanks are usually designed to hold enough water for 1 to 3 days of consumption.

For the example system a tank size of 2 days of capacity, i.e. 30 m<sup>3</sup> was chosen on the basis of previous experience in the same region.

#### **Sizing the storage for irrigation**

When a wind pump is used for irrigation, a storage tank is virtually indispensable. The tank should have a minimum capacity large enough to store about half-a-day's output in the month of highest demand.

For economic reasons the maximum size is normally 1 or 1.5 days of storage. Of course, this upper limit depends on the cost of the tank. If a storage tank can be made fairly cheaply, a somewhat larger capacity may be justified. Obviously, one enters here into an iterative process going from sizing to economic evaluation and back again.

The maximum cost (and hence the maximum size) of the storage tank also depends somewhat on the crops to be grown. For high-value crops, a somewhat higher cost for the storage tank may be acceptable.

A very detailed way of sizing a tank is possible on the basis of sequential hourly wind data. One may calculate the output of a windmill on an hourly basis, and calculate excess and deficit of water. Analyzing these data one may choose an appropriate size for the storage tank.

When doing so, one should not aim at bridging long windless periods by means of the storage tank, since this does normally not lead to an economic optimum. Generally it is more economic to accept periods with little water and some loss of crop productivity, or alternatively decide to apply a back-up engine-driven pump or increase the size of the wind pump.

For more information on sizing storage tanks, see Appendix B, Section B.4.

#### e. The piping

The network of pipes that carries water to the storage tank is an integral part of the wind pump system. The piping network behind the storage tank is part of the consumer's system and is not treated here. It can be designed using well-established engineering rules.

In order to size the piping, the maximum flow rate of the water must first be estimated.

If the wind pump system is designed according to the previous steps, the maximum pumping rate will be approximately 3 to 5 times the average pumping rate in the design month. If there are no air chambers, the flow of water pumped will not be continuous but pulsating. The peak flow will be approximately 3 times the maximum pumping rate.

The following flow rates are suggested for sizing the pipe work:

- Wind pump without air chambers — 10 to 15 times the average pumping rate during design month.
- Wind pump with air chambers — 3 to 5 times the average pumping rate during design month.

The pipe diameter required to keep the head loss within acceptable limits may be determined from Figure 3.6.

The piping of a wind pump must be designed for a relatively low head loss of around 10% of total pumping height. This is because variations of the flow in the pipes cause considerable forces in the pump rod and may cause it to break. In order to limit these forces, the pipes should be relatively large. Sometimes wind pump manufacturers specify the minimum pipe diameter to be used. A complete calculation procedure for this aspect is beyond the scope of this handbook.

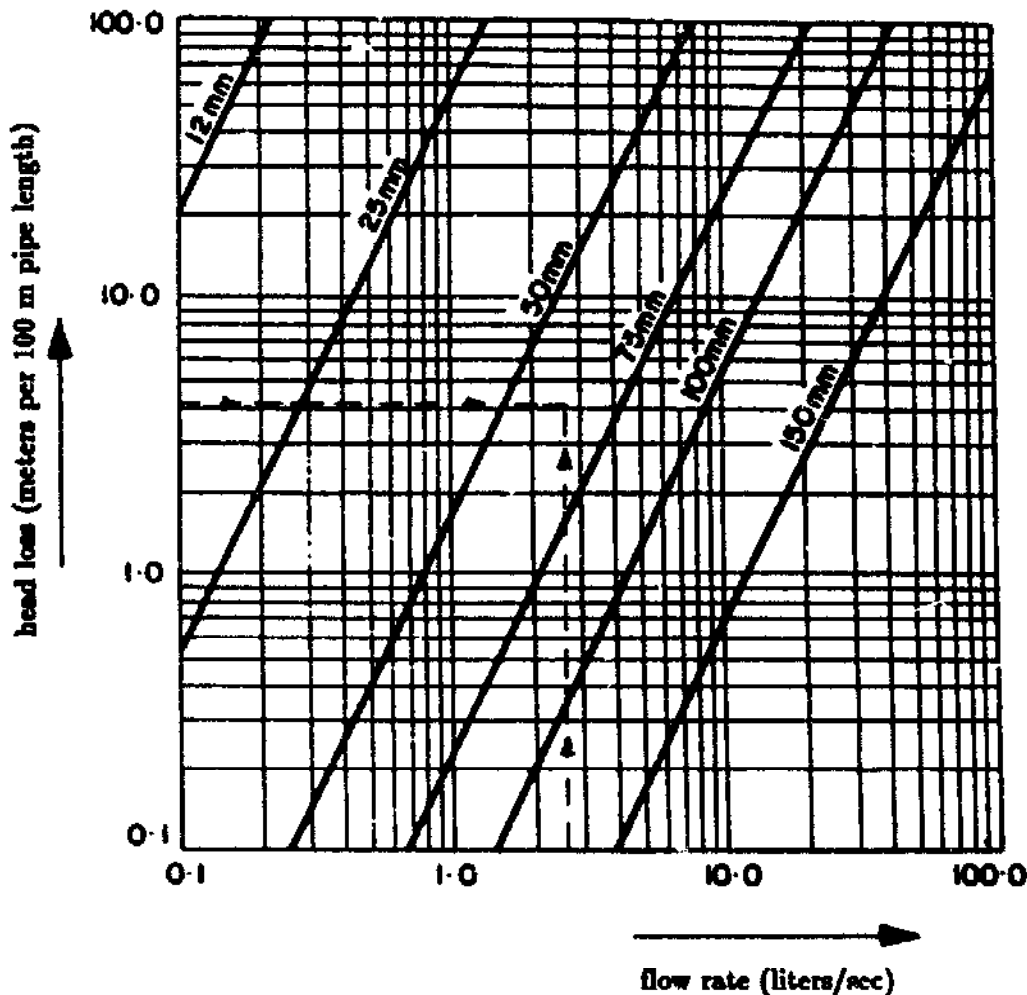

Figure 3.6. Head loss in smooth pipes of different internal diameters

Special attention must be paid to the suction line, if a suction pump is applied. It must be checked that the total suction head, i.e. the suction height plus the pressure loss in the suction line, does not exceed 6 or 7 m.

In the example system the average pumping rate in the design month is 15 m<sup>3</sup>/day, or 0.17 l/s. A classical windmill without air chambers is applied. Hence the pipe work must be designed for a flow rate of 2.6 l/s. According to Table 3.4, a head loss of 10% corresponds to 2 m. Since the total length of pipe is 50 m, the head loss may be 4 m/100 m. From Figure 3.6 one finds a pipe diameter of 65 mm, approximately 2½".

### 3.6. Preparing the final specifications

The reader should now be in a position to make his own preliminary assessment of wind pumping viability in accordance with Chapter 1, and to supply full details of his requirements. Before a system is purchased it is important to ensure that it is technically able to meet the demand and that it will meet the economic constraints.

WIND PUMP PERFORMANCE SPECIFICATION												
Location: <b>FLAMENGOS, CAPE VERDE</b> .....		Height above sea level... <b>4100</b> .....m										
1. Water source		Type: <b>TUBEWELL, DIAMETER 145 mm</b> ..... Distance (for surface pumping).....m Diameter (for wells)..... <b>145</b> .....mm Water level (when pumping)... <b>10</b> .....m										
2. Delivery system		Type..... <b>PIPE</b> ..... Length..... <b>60</b> .....m Pipe diameter... <b>2 1/2" = 65</b> .....mm Efficiency..... <b>100</b> .....%										
3. Storage system		Type..... <b>TANK ON HILL SIDE</b> ..... Volume..... <b>30</b> .....m <sup>3</sup> Height..... <b>12</b> .....m										
4. Design month details		Month..... <b>AUGUST</b> ..... End use water requirement. <b>15</b> .....m <sup>3</sup> /day Pumped water requirement. <b>15</b> .....m <sup>3</sup> /day Hydraulic power requirement... <b>42</b> .....W Average wind speed at hub height..... <b>3.3</b> .....m/s										
5. Wind regime and water requirement												
	Jan	Feb	Mar	Apr	May	Jun	Jul	Aug	Sep	Oct	Nov	Dec
average wind speed at hub height (m/s)	<b>4.9</b>	<b>5.4</b>	<b>5.4</b>	<b>5.1</b>	<b>5.5</b>	<b>4.6</b>	<b>3.5</b>	<b>3.3</b>	<b>3.5</b>	<b>4.4</b>	<b>4.4</b>	<b>4.9</b>
pumped water requirement (m <sup>3</sup> per day)	<b>15</b>	<b>15</b>	<b>15</b>	<b>15</b>	<b>15</b>	<b>15</b>	<b>15</b>	<b>15</b>	<b>15</b>	<b>15</b>	<b>15</b>	<b>15</b>
6. Windmill specification		Tower height..... <b>12</b> .....m Machine type <b>CLASSICAL BACK GEARED</b> ..... rotor diameter... <b>14" = 4.3</b> .....m stroke..... <b>12" = 305</b> .....mm Pump type..... <b>DEEPWELL</b> ..... cylinder diameter... <b>4" = 102</b> .....mm										

Table 3.8. Format sheet for specification of wind pump performance.



A specification sheet, which may be included in a tender document (see Appendix F) is shown in Table 3.8. When issuing the tender documents the purchaser should complete at least items 1 to 4 and preferably also item 5, and fill in the tower height in item 6.

However, if the purchaser intends to make his own economic assessment before contacting a supplier, all items of the specification sheet should be completed as far as possible. These data are required for the financial assessment detailed in Chapter 5.

It is useful to complete items 5 and 6 as a check on the system proposed by the tenderer. Most manufacturers of water pumping windmills have only an approximate idea of the output performance of their machines, especially in regions where they have no experience in estimating the wind potential. Some guidance on the required rotor diameter should also be given (normally manufacturers do not give any output guarantee).

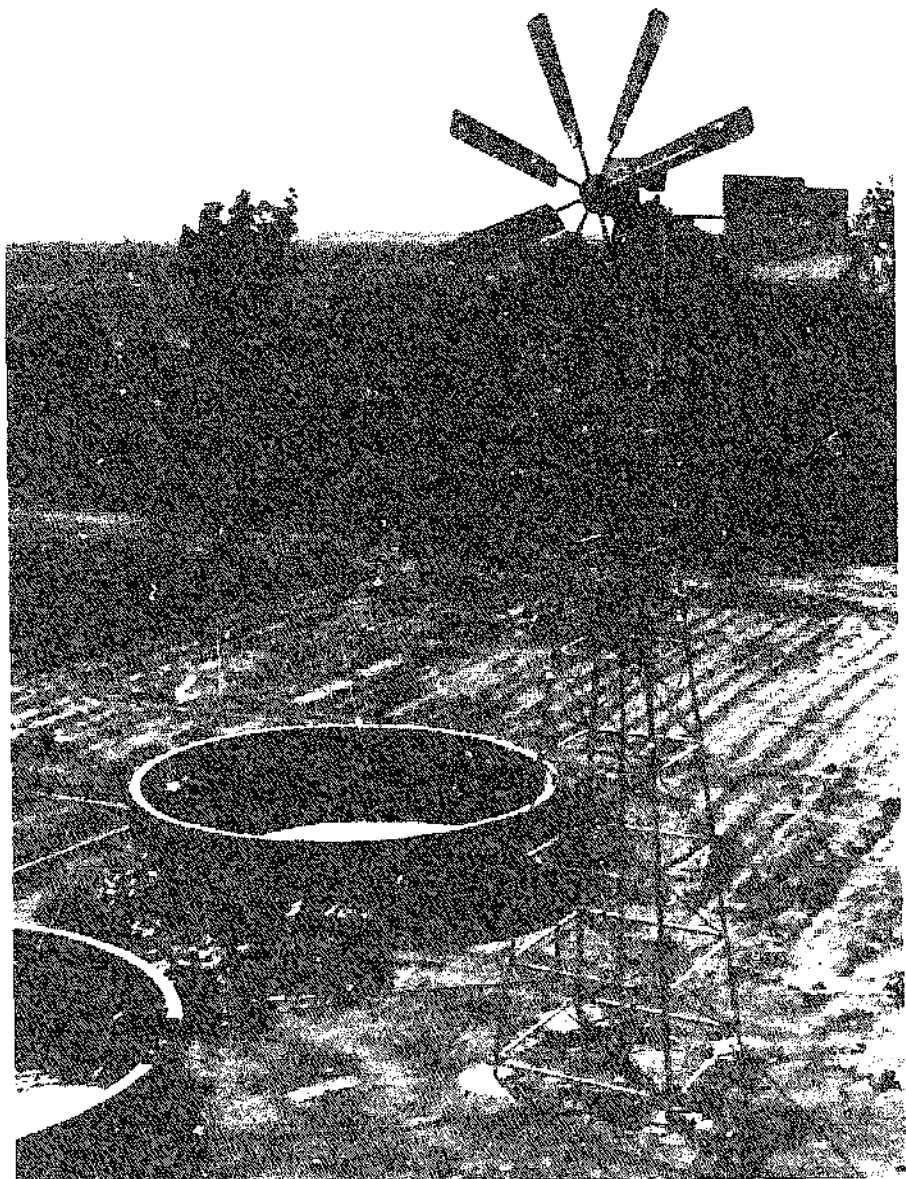

*In specifying the wind pump all items should be included: water source, wind pump, delivery system, storage system and distribution or field application system. Soba experimental farm, Sudan 1987*

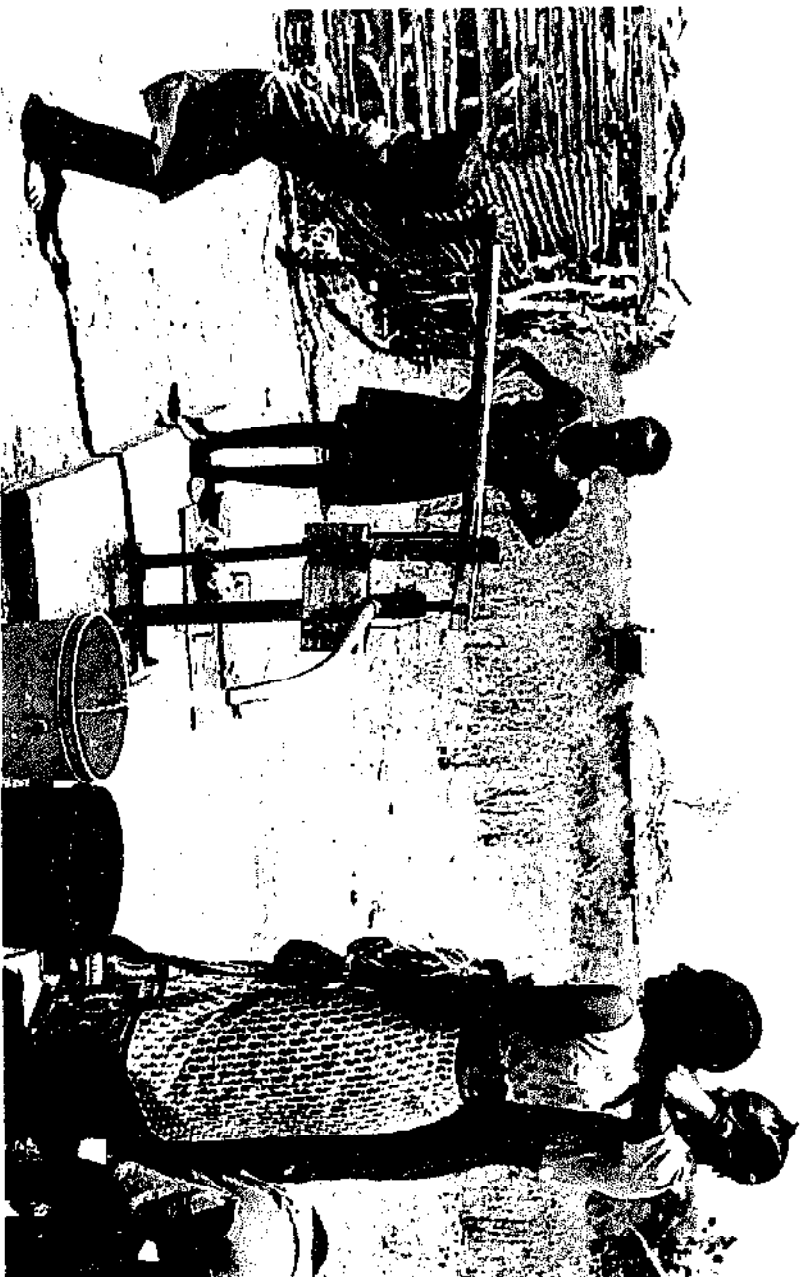

*Hand pump in Tanzania.*

## **Chapter 4**

# **SIZING OF ALTERNATIVE SMALL WATER PUMPING SYSTEMS**

When considering the use of a wind pump, it is good practice to consider alternative pumping systems also. In this chapter a brief summary is given of the technical performance characteristics and sizing aspects of the main alternative small-scale pumping technologies.

The following pumping techniques are included:

- solar pumps
- engine-driver pumps (diesel, kerosene)
- animal traction and hand pumps.

It would be beyond the scope of this handbook to give complete sizing procedures for all types of pumps. Electric pumps have not been included, for example, since the evaluation of small electric pumps in comparison to alternative technologies is quite simple. If a grid connection exists and if electricity supply is sufficiently guaranteed, electric pumping is in general the most economic solution. If long electric lines are required and/or if a special transformer has to be installed, electric pumping is often excessively expensive.

Wind pumps are not included here as the procedures for sizing wind pumps were covered in Chapter 3. The reader should use the information in Chapter 3 to estimate the size of wind pump needed for a given situation, then size alternative systems following the procedures given in this chapter, and finally make cost comparisons between the systems based on information contained in Chapter 5. In this way it should be possible to decide whether to investigate any of the alternative systems further, or whether to pursue wind pumping.

Sizing of alternative pumping systems can be done following the steps given in Figure 3.1, Chapter 3 for sizing wind pumps. They are:

- Assess the water requirements
- Determine the hydraulic power requirements.
- Determine the available power resources (in case of solar).
- Identify the design month.
- Size the power source and pump.

As the first step, assessing the water requirements, is identical for all pumping technologies, it will not be repeated here. The reader should refer to Chapter 3, Section 3.1.

If one of the alternatives looks attractive, the reader should refer to specialized literature and/or contact an expert on the subject for more precise sizing and final detailed specification (Figure 3.1, Chapter 3).

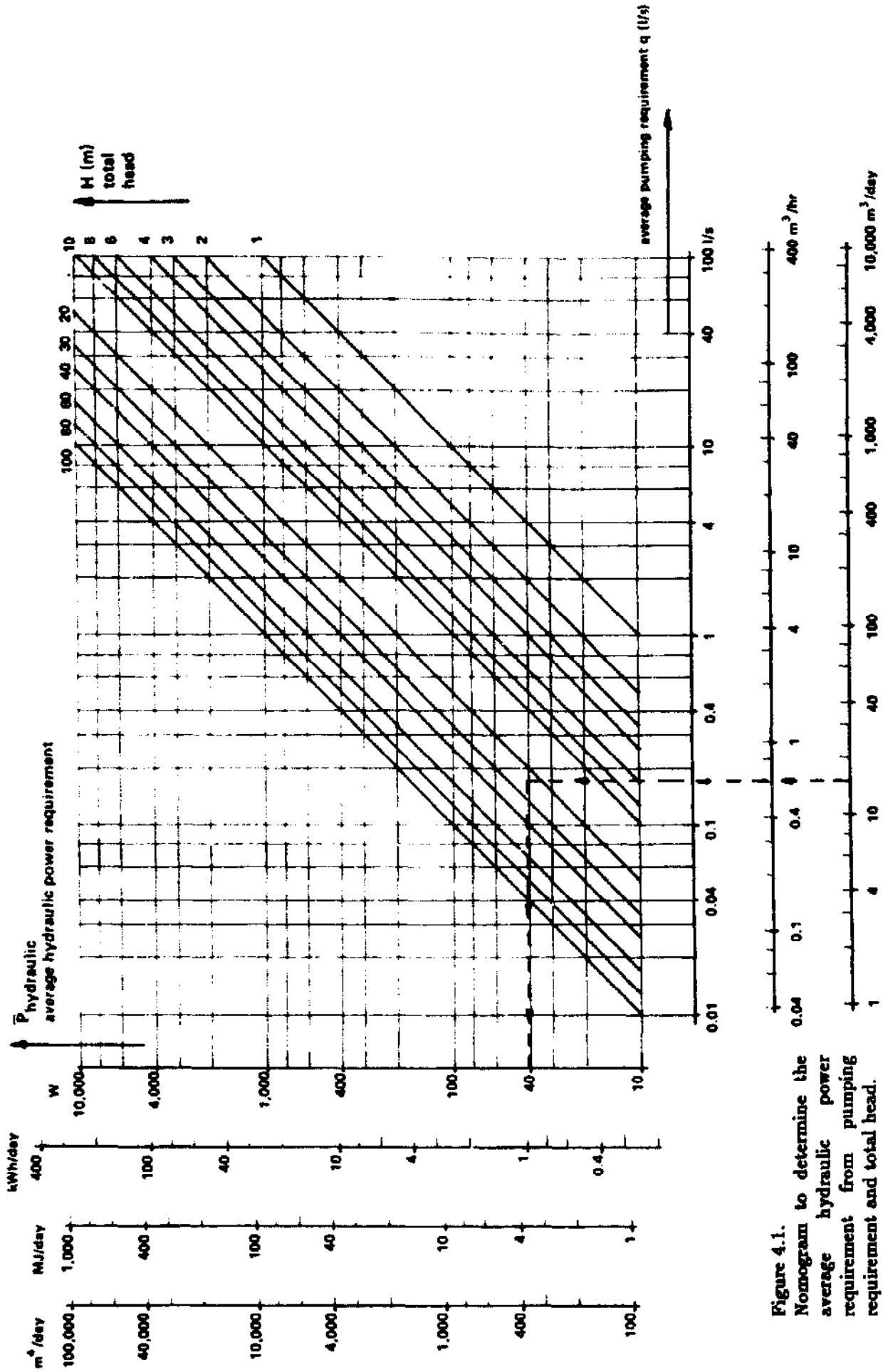

Figure 4.1. Nomogram to determine the average hydraulic power requirement from pumping requirement and total head.

## 4.1. Determining monthly hydraulic power requirements

This step is identical for all pumping systems. It was extensively described in Section 3.1. In short, the average monthly pumping rates must be determined as well as the total pumping head. The hydraulic power requirement may be calculated using the formula given in Section 3.1, or using the nomogram in Figure 4.1 (which includes the most common units in use). Also calculate the total annual water requirement. Use the format sheet of Table 3.4 to summarize the information.

For the example wind pump system the pumping requirement is constant throughout the year: 15 m<sup>3</sup>/day. With a total pumping head of 24 m one finds an average hydraulic power requirement of 41 W. The total annual water requirement is 5475 m<sup>3</sup>.

## 4.2. Determining the available power resources

For solar power, data are required in a format similar to that used in Section 3.2, Chapter 3. In comparison with wind power, variations are far smaller. In tropical regions, the solar irradiation reaching the earth's surface is of the order of 10 to 20 MJ/m<sup>2</sup>/day (or 100 to 200 W/m<sup>2</sup>). The methods for obtaining data on solar power are described in detail in the solar pump handbook (reference 1).

Other power sources (engine fuel, animal, human power) are assumed to be available on demand. In reality the availability of fuel sometimes poses problems.

For the example system the wind power resources were indicated in Section 3.2.

## 4.3. Determining the design month

For the example wind pump system, the design month is August (see Table 3.6). The procedure for identification of the design month for wind pumps is outlined in Section 3.3.

**Solar pumps:** the design month is the month having the highest ratio of daily average water requirements to daily average solar irradiation  $H$ .

**Engine, animal and hand pumps:** the design month is the month with the highest water demand. It should be noted, however, that the real costs of pumping may increase in harvesting and sowing periods when both human and animal labor are in short supply.

## 4.1. Determining monthly hydraulic power requirements

This step is identical for all pumping systems. It was extensively described in Section 3.1. In short, the average monthly pumping rates must be determined as well as the total pumping head. The hydraulic power requirement may be calculated using the formula given in Section 3.1, or using the nomogram in Figure 4.1 (which includes the most common units in use). Also calculate the total annual water requirement. Use the format sheet of Table 3.4 to summarize the information.

For the example wind pump system the pumping requirement is constant throughout the year: 15 m<sup>3</sup>/day. With a total pumping head of 24 m one finds an average hydraulic power requirement of 41 W. The total annual water requirement is 5475 m<sup>3</sup>.

## 4.2. Determining the available power resources

For solar power, data are required in a format similar to that used in Section 3.2, Chapter 3. In comparison with wind power, variations are far smaller. In tropical regions, the solar irradiation reaching the earth's surface is of the order of 10 to 20 MJ/m<sup>2</sup>/day (or 100 to 200 W/m<sup>2</sup>). The methods for obtaining data on solar power are described in detail in the solar pump handbook (reference 1).

Other power sources (engine fuel, animal, human power) are assumed to be available on demand. In reality the availability of fuel sometimes poses problems.

For the example system the wind power resources were indicated in Section 3.2.

## 4.3. Determining the design month

For the example wind pump system, the design month is August (see Table 3.6). The procedure for identification of the design month for wind pumps is outlined in Section 3.3.

**Solar pumps:** the design month is the month having the highest ratio of daily average water requirements to daily average solar irradiation  $H$ .

**Engine, animal and hand pumps:** the design month is the month with the highest water demand. It should be noted, however, that the real costs of pumping may increase in harvesting and sowing periods when both human and animal labor are in short supply.

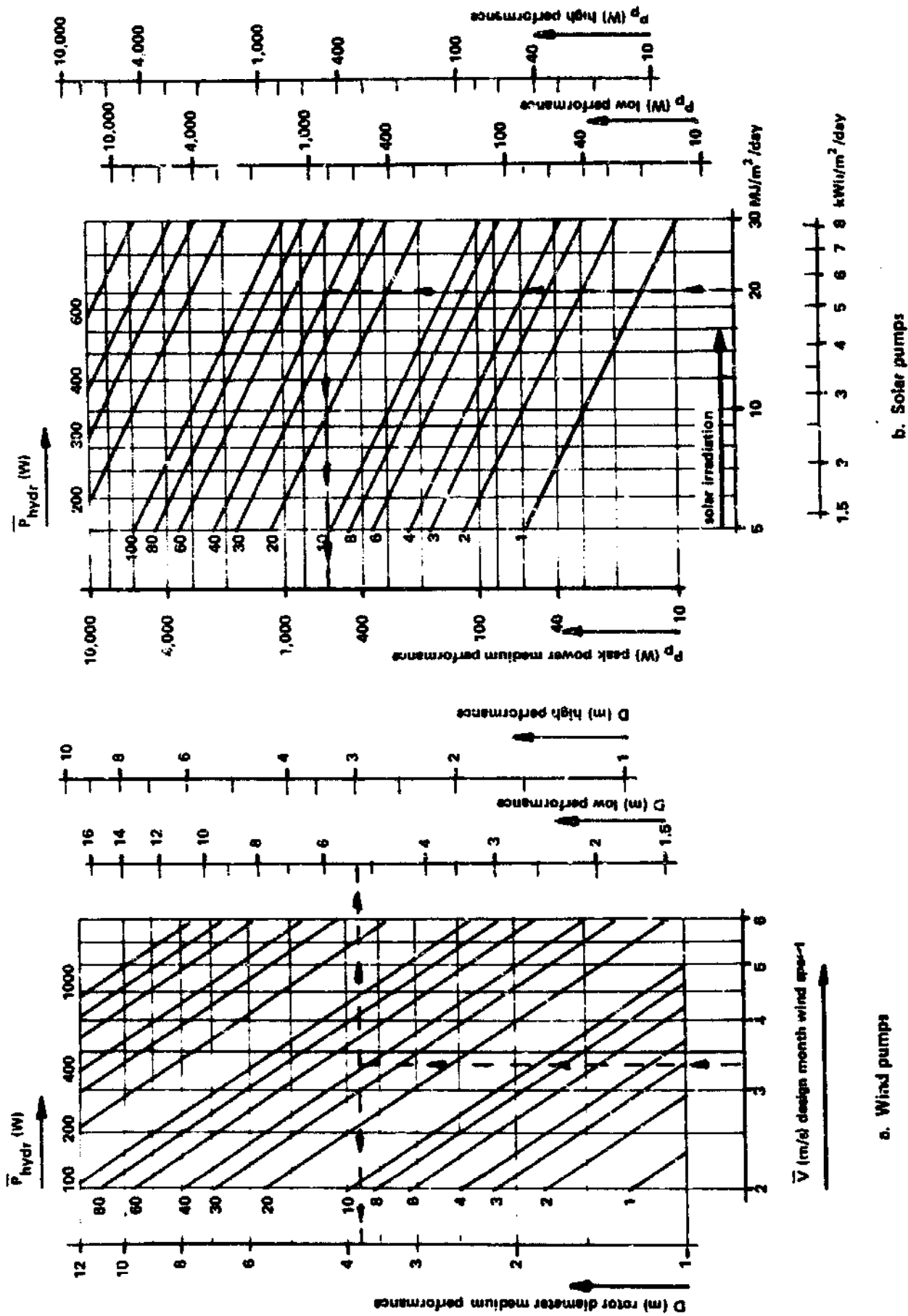

Figure 4.2 Nomograms for approximate sizing of wind and solar pumps

## 4.4. Sizing the power source and pump

### 4.4.1. Wind pumps

A detailed procedure for sizing wind pumps was given in Section 3.4, Chapter 3.

For the example system, the design month power requirement is 41 W. The average wind speed in the design month is 3.3 m/s. The performance of the wind pump, being a classical wind pump with high pumping head, will lie somewhere between "low" and "medium". In this way one finds from the nomogram in Figure 4.2 a rotor diameter between 3.8 and 5.4 m. With the detailed method of Section 3.4, we found 4.5 m, resulting in the choice of a 4.3 m wind pump. The same order of magnitude is obtained from the simplified nomogram of Figure 4.2.a.

A tank size of 30 m<sup>3</sup> is chosen, somewhat more than two days of storage.

### 4.4.2. Solar pumps

A photovoltaic array (PV array) is rated at a temperature of 25°C under full sunshine (specifically 1000 W/m<sup>2</sup> irradiance) by its electrical output, i.e. its peak power performance in Watts. The efficiency of solar cells at peak power lies between 10 and 13%. At higher temperatures the efficiency is lower.

The pumping unit is designed to be well matched to the array under full sunshine conditions. At lower irradiation levels, however, the matching is poorer and the total efficiency of the system drops.

It is customary (reference 1) to define a **daily subsystem efficiency**  $\eta_s$ , defined as the ratio of daily hydraulic energy output to the daily electrical energy input from the solar panel.

Table 4.1 (taken from the "Solar Water Pumping Handbook, reference 1) provides a guide on typical values  $\eta_s$  for different types of system configuration.

From Table 4.1. we have chosen three typical levels of performance:

- low performance,  $\eta_s = 25\%$
- medium performance,  $\eta_s = 35\%$
- high performance,  $\eta_s = 45\%$ .

The overall (daily) average efficiency — the ratio of the daily water energy output to the solar irradiation input — is the product of the array efficiency times daily subsystem efficiency; e.g. if  $\eta_{array} = 10\%$  and  $\eta_s = 35\%$  then the overall (daily) efficiency is 3.5%. A value of 5% represents a system with a good efficiency.



Lift	Sub-system type	Typical subsystem daily energy efficiency		Typical subsystem peak power efficiency	
		Average	Good	Average	Good
2 meters	- Surface suction or floating units with submerged suction utilizing brush or brushless permanent magnet, d.c. motors and centrifugal pumps	25%	30%	30%	40%
7 meters	- Floating d.c. units with submerged pump - Submerged pump with surface mounted motor, brush or brushless permanent magnet d.c. motors single or multi-stage centrifugal pumps	28%	40%	40%	60%
20 meters	- a.c. or d.c. submerged multi-stage centrifugal pump set, or - Submerged positive displacement pump with d.c. surface motor	32%	42%	35%	45%

Table 4.1. State of the art for motor/pump subsystem of solar pumps (reference 1)

Also for solar pumps one needs to consider the sizing of the storage tank. For irrigation the storage tank may be somewhat smaller than in the case of a windmill, since some water is pumped during daylight hours each day. For rural water supply one may assume two days of storage.

The example case is also indicated in Figure 4.2.b., assuming the solar power in the design month to be 20 MJ/m<sup>2</sup>/day (or 5.5 kWh/m<sup>2</sup>/day) and assuming a medium performance level. As indicated earlier the average hydraulic power requirement in the design month is 41 W. If a solar pump were to be used in the example instead of the wind pump, the solar photovoltaic panels should have a peak power rating of 600 W.

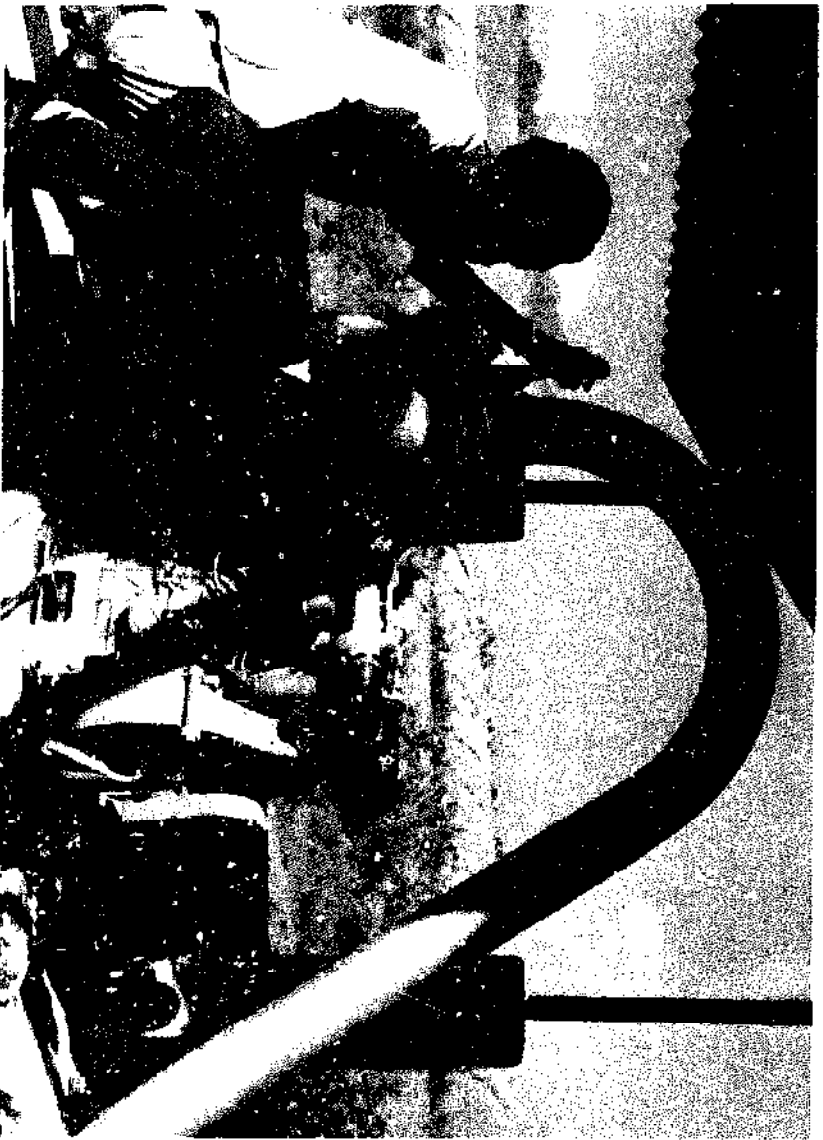

*Diesel engine pumping system in Somalia.*

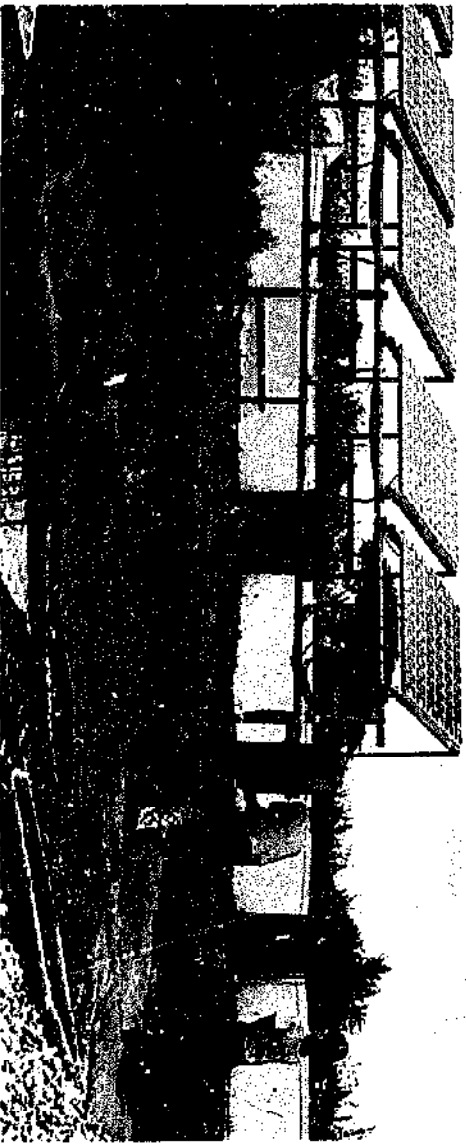

*Solar pumping system in Somalia.*

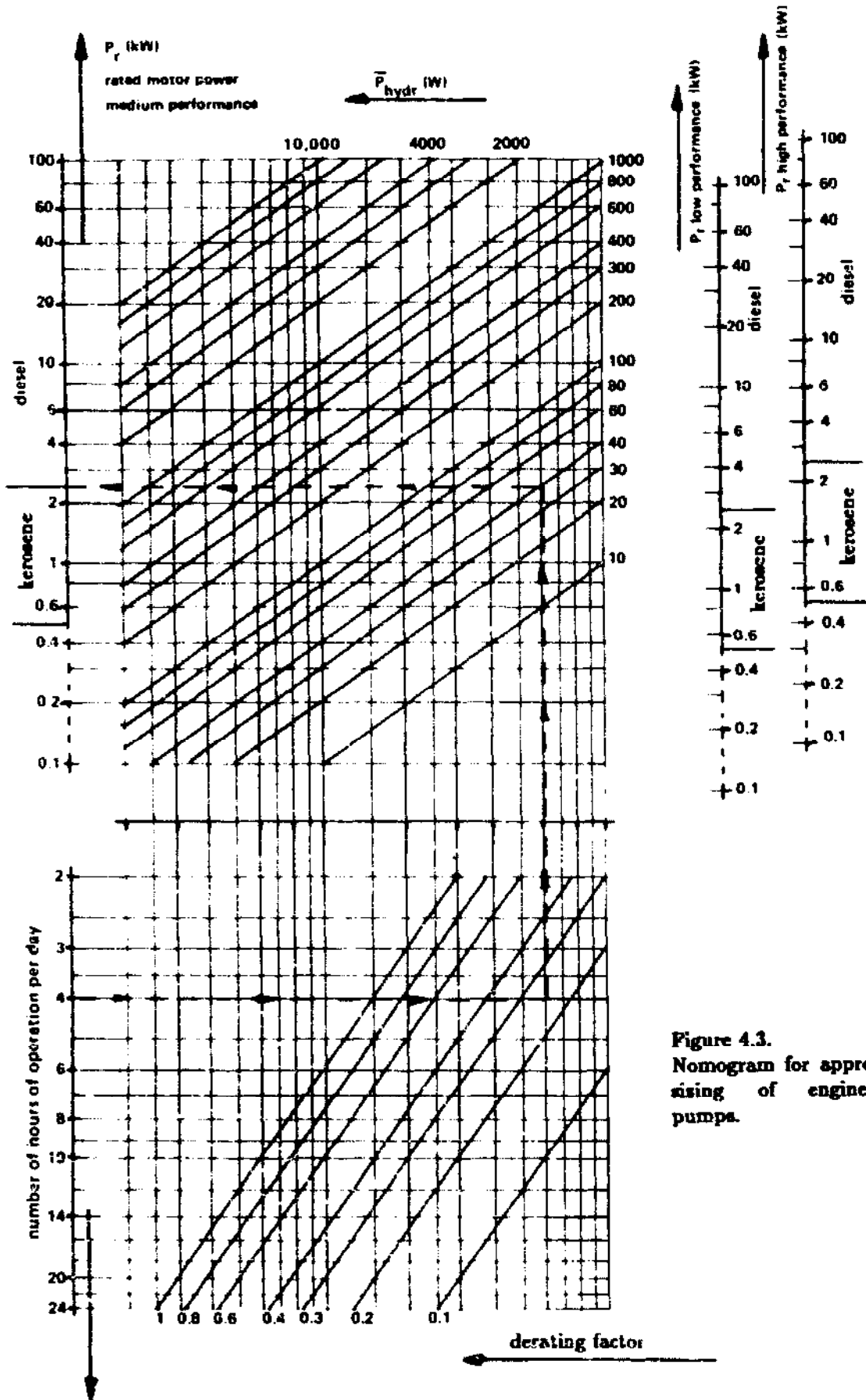

Figure 4.3.  
Nomogram for approximate  
sizing of engine-driven  
pumps.

### 4.4.3. Engine-driven pumps

Figure 4.3 may be used for an approximate sizing of engine-driven pumps. The following aspects are to be taken into account:

- o Number of hours of operation. This is related to irrigation practices, presence of a storage tank, etc. For example, for direct field application a small kerosene pump may be operated by its owner for four hours per day. For a large irrigation scheme of several farms, a diesel pump may operate twelve hours per day.
- o Derating factor. Usually the engine is oversized in relation to the pump. For small pumps the de-rating may be around 0.5, for large motor pump sets, matched to the application, it may be 0.7.
- o Minimum motor size. The smallest size of diesel motor readily available is approximately 2.5 kW, and the smallest size of kerosene motor used in pump sets is of the order of 0.5 kW. For very small pumping requirements these sizes may be too large. In such cases the number of hours of operation will be reduced. Sometimes the derating factor is further reduced.

From the nomogram in Figure 4.3 three values may be found for the size of the motor for different levels of performance, characterized by the combined efficiency of the pump and lines:

- Low performance,  $\eta_{\text{pump,lines}} = 30\%$
- Medium performance,  $\eta_{\text{pump,lines}} = 40\%$
- High performance,  $\eta_{\text{pump,lines}} = 50\%$

For very small pumps and low pumping heads, the performance can be expected to be relatively low. For large sizes and larger pumping heads, a relatively high performance can be expected.

Storage tanks are normally not used for irrigation with engine pumps. Rural water supply schemes usually incorporate storage tanks with a capacity of half a day to two days.

The example case is also indicated in Figure 4.3. Since the example is concerned with a deep tubewell, the type of engine pump to be applied will be a deep-well turbine pump driven by a diesel motor. As indicated earlier, the average hydraulic power requirement is 41 W. For a diesel pump, this is a relatively low requirement, and one will apply the smallest available size of diesel motor: 2.5 kW. A medium level of performance can be expected (large pump head, but relatively small size). Since the pump is too large in comparison to the water requirement, it is used only 4 hours a day with a derating factor of 0.25 (this corresponds to a pump demanding 630 W power input).

### 4.4.4. Animal traction and hand pumps

Figures 4.4.a and b, taken from the solar handbook (reference 1) give an estimate of the number of animal or hand pumps needed to provide the required quantity of water. Where actual figures of the output of hand and animal pumps are known, these should be used in preference to the estimates of Figure 4.4.

With respect to the example case: Technically it is very difficult to apply animal traction pumps for pumping from a deep tubewell. It would be possible to install a hand pump. However, as can be seen from the nomogram in Figure 4.4.b one hand pump would not be able to fulfil the pumping requirements: 15 m<sup>3</sup>/day at 24 m head. Drilling tubewells to accommodate a sufficient number of hand pumps would be prohibitively expensive.

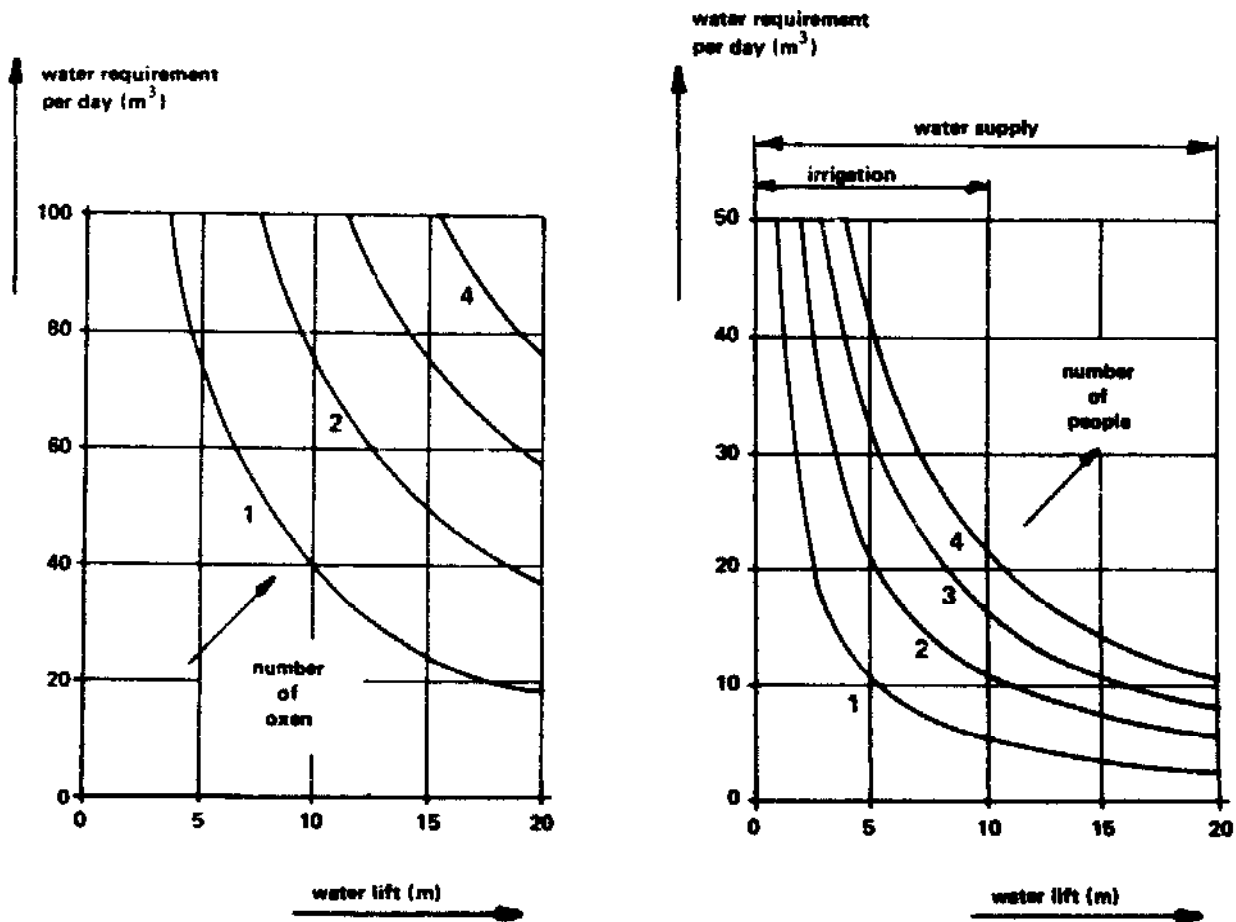

a. Number of oxen required to provide the specified quantity of water at different lifts. The curves have been calculated by assuming that an ox can provide 350 Watts of power for 5 hours per day, and that the efficiency of the water lifting device is 60%.

b. Number of people required to provide the specified quantity of water at different lifts. The curves have been derived by assuming that a single person can provide 60 Watts of power for 4 hours per day and that the efficiency of the hand pump is 60%.

Figure 4.4. Graphs for approximate sizing of animal traction and hand pumps (reference 1).



*Animal traction for pumping.*



*Irrigation of rice with a 12-PU-500 wind pump in India.*

## Chapter 5

# FINANCIAL ASSESSMENT

This chapter is designed to help the reader evaluate the economics of a wind pumping system and compare the costs of wind pumping with the alternative pumping systems described in Chapter 4. In Section 5.1, we make a distinction between an economic analysis, which generally must be made by policymakers on a national level, and a financial analysis, which looks at the wind pump investment from the perspective of the user. Section 5.2 gives a step-by-step procedure for comparing the costs of different pumping technologies in a specific situation, using data from the example site (Flamengos, Cape Verde) referred to in Chapter 3 (Figure 3.1). Section 5.3 provides general data on costs for the various types of pumping system. The final section of the chapter, Section 5.4, gives a comparison of unit water costs for different pumping systems, based on typical cost values of investment, maintenance, fuel consumption, and so on. The methodology for making these comparisons is presented in Appendix C.

While the cost figures given in this chapter can be used in a general way for comparison, it should be emphasized that a proper evaluation for a specific situation must be based on actual costs of materials, interest rates, maintenance costs, subsidies and other cost factors in the specific region for which a decision on investment in a wind pumping system will be made.

### 5.1. Economic and financial analysis

An economic or financial analysis is intended to determine whether the investment in a wind pump is justified. Such an analysis can also help to determine if it makes sense to start a dissemination program. Clearly its success depends on whether or not prospective users benefit from investing in the technology.

The user in this context may mean:

- The national community
- The private investor, whether it be a farmer or an institution of some kind, wanting to use wind pumps

As criteria for these two categories rarely, if ever, fully coincide, it is customary to discern two levels of analysis:

- o Economic analysis (also referred to as national or macroeconomic analysis): Is the investment profitable from a national resource allocation perspective?
- o Financial analysis (also referred to as business or microeconomic analysis): Is the investment profitable from the user's perspective?



Foreign currency savings and employment generation are important aspects of economic analysis. The analysis ignores national taxes and subsidies as these only represent transfer of money within the national community. Market prices are converted to shadow prices, which represent the real economic value of a commodity. Economic analysis is beyond the scope of this handbook, but it should be mentioned here that the introduction of wind pumps goes hand in hand with foreign currency savings and employment generation, more so if wind pumps are produced locally.

Financial analysis for the direct user can be split up into two parts:

- o Cost-benefit analysis: is the investment profitable, i.e. do the total benefits exceed the costs over a certain period?
- o Cash flow analysis: can the user finance his investment?

In a cash flow analysis all expenditures and receipts are calculated year by year. All loans, subsidies, profits, the user's own capital, etc. should be included in the analysis. If the farmer is to survive, all expenditures within one single year must be covered by receipts in that same year.

While we must stress the importance of the cash-flow analysis, it is impossible to make general statements about it, as so many factors depend on local conditions. However, it is important to note that wind pumps, like solar pumps, demand relatively high capital investments compared with engine-driven or other pumps. The prospective user must consider carefully whether he can afford to invest in a wind pumping system.

Only the cost-benefit analysis is discussed in this handbook. By using the information given in this chapter, the prospective owner of a wind pumping system should be able to determine whether his investment will be profitable.

The owner may be a small private farmer, owning one windmill, or a water supply authority owning a large number of windmills. The cost-benefit analysis is made on the basis of real prices and costs as they are received or paid by the owner. Of course, taxes and subsidies are included, as they are a reality to the owner.

A complete cost-benefit analysis is divided into two parts:

- o Analysis of costs related to purchase, transport, installation, operation, maintenance, repair, spare parts, lubricants, and (in the case of an engine-driven pump) fuel.
- o Analysis of benefits such as receipts from the sale of agricultural products or water, fuel saving, increased food self sufficiency, and so on. Benefits may be relatively low in the first few years while the farmer is gaining experience with windmill irrigation) and increase in later years.

The costs and benefits may be analyzed in several ways in order to draw conclusions as to the profitability of an investment. The different methods are named according to the criteria used, e.g., cost/benefit ratio, pay back period, net present value, internal rate of return.

For all these methods one needs to know the benefits. However, it is difficult to make any general statements on benefits since these depend strongly on the specific application and local situation. Therefore, this handbook will only treat costs, expressed as unit cost of the water delivered to the user.

On the basis of unit water costs one can make cost comparisons between different technologies serving the same purpose, assuming that the benefits are approximately equal. This kind of analysis is also known as "least cost analysis".

Costs are basically divided into investment costs (or capital costs) and recurrent costs. The investment is a cost incurred once in the lifetime of an installation (although payment of terms and interest may be spread over a longer period). Recurrent costs occur every year in more or less the same way. They include operation, maintenance and repair costs.

In order to make investment and recurrent costs comparable one may adopt two approaches:

- o **Annuity method.** Convert the investment into an equivalent yearly cost called the annuity. This is the amount of money that would have to be paid every year during the (economic) lifetime of the installation, if the investment were financed through a loan. The annuity is constant throughout the years, exactly covering repayment of the investment and interest on the debt. The total yearly costs is then obtained by adding the annuity and the recurrent costs together.
- o **Present worth method.** Convert the recurrent costs into an equivalent capital, the present worth. The present worth of future costs is the amount of capital that should be reserved at the moment of investment in order to cover all future costs. It is calculated taking the interest on the capital (or what is left of it) into account.  
The total "life cycle cost" is then obtained by adding the investment cost and the present worth of the recurrent costs together.

In this handbook we will use the annuity method. It is somewhat simpler than the life cycle cost method and the results are more directly understandable for a broad audience. The conclusions that can be drawn from both methods are practically identical, although the annuity method is somewhat more limited with respect to future cost escalations of isolated cost components, such as fuel.

For a detailed and comprehensive overview of the methods used in financial analysis, see reference 15.

It must be emphasized that no economic or financial evaluation is complete without a sensitivity analysis. The assumptions on which an evaluation is based are often subject to a large margin of uncertainty. After arriving at a certain figure as the result of an economic or financial evaluation, one must also indicate how the figures obtained would change if the assumptions were varied within a reasonable range, for instance if interest rates rose at a faster rate than expected, or if the costs of operation and maintenance and other recurrent costs increased more than anticipated.

UNIT WATER COST FOR A SMALL SCALE PUMPING SYSTEM	
System description	
Location.....	FLAMENGOS, CAPE VERDE.....
Design month <i>AUGUST</i> ....	Design month pumping requirement.... <i>15</i> .....m <sup>3</sup> /day
Total head... <i>24</i> .....m	Design month hydraulic power requirement..... <i>41</i> .....W
Annual water requirement... <i>5475</i> ...m <sup>3</sup>	
Power source... <i>WIND PUMP</i> .....	Size... <i>4.3 m DIAMETER</i> .....
Storage tank size..... <i>30</i> .....m <sup>3</sup>	
Economic information	
Interest rate.....	Real interest rate... <i>10%</i> .....
Inflation rate.....	
Costs	
System component 1: <i>WIND PUMP</i> .....	
Investment... <i>US \$ 4943</i> .....	
Lifetime..... <i>10</i> .....years	
Annuity..... <i>16%</i> .....	
Average annual capital cost.....	<i>\$ 191</i> .....
Average annual cost of maintenance and repair... <i>\$ 200</i> .....	
System component 2: <i>STORAGE TANK AND PIPING</i>	
Investment... <i>US \$ 3618</i> .....	
Lifetime..... <i>15</i> .....years	
Annuity..... <i>13%</i> .....	
Average annual capital cost.....	<i>\$ 470</i> .....
Average annual cost of maintenance and repair... <i>\$ 36</i> .....	
Annual cost of operation of the system.....	<i>\$ 474</i> .....
Total annual costs	<i>US \$ 1971</i>
Unit water costs	<i>US \$/m<sup>3</sup> 0.36</i>

Table 5.1.a. Format sheet to calculate the unit water cost of a small-scale pumping system. Completed for the example wind pump system of Chapter 3, Flamengos, Cape Verde.

## 5.2. Procedure for a simplified cost comparison of small-scale water pumping techniques in a specific situation

As indicated in the preceding section, a complete economic and financial analysis including costs and benefits, is outside the scope of this handbook, especially as many parameters involved are very specific to local situations. However, for a first appraisal, we can compare the bare costs of water. The procedure presented here allows the reader to compare these costs for the principal small-scale water-lifting systems:

- Wind pumps
- Solar pumps
- Engine-driven pumps (diesel or kerosene)
- Animal-powered pumps
- Hand pumps

The technical performance and sizing aspects for these systems were treated in Chapter 4. As already mentioned in that chapter, electric pumps are not considered, since the evaluation of small electric pumps in comparison to alternative technologies is normally rather simple and obvious: If a grid connection exists, electric pumping — assuming electricity supply is sufficiently guaranteed — is in general the most economic solution. If long electric lines are required and/or if a special transformer has to be installed, electric pumping is normally excessively expensive.

In order to calculate the cost of water delivered to the user, the complete system should be considered, including the water source (well), power source, pump, piping, storage tank, distribution network, and — in case of irrigation — field application.

When comparing different pumps, one may leave out some of the components. For example, if a certain amount of water is to be pumped from a well, using either a wind pump or an engine-driven pump, one may leave out the cost of the well, which is the same in both cases. One will then find the costs of pumping water (which may be used for a comparison), and not the total cost of the water. The same can be true for other cost components, e.g. field application. But one must first make sure that calculations used for comparisons are truly comparable.

The cost comparison procedure as presented in this section is based on the following main assumptions:

- Benefits are equal for different pumping technologies.
- The rate of interest is constant.
- The rate of inflation is constant and equal for all cost components.

The procedure for cost comparison corresponds to the economic/financial boxes in Figure 3.1, Chapter 3.

- Calculate the average annual capital cost (AACC).
- Calculate the annual recurrent costs (ARC).
- Calculate the unit water costs.

Once these costs have been calculated one can then determine **sensitivity** of the outcome to variation in the input data, such as change in interest rate, wind speed, and so on.

UNIT WATER COST FOR A SMALL-SCALE PUMPING SYSTEM	
System description	
Location.....	FLAMENGOS, CAPE VERDE
Design month.....	Design month pumping requirement.....15.....m <sup>3</sup> /day
Total head.....24.....m	Design month hydraulic power requirement.....41.....W
Annual water requirement..	547.5...m <sup>3</sup>
Power source.....	SOLAR PUMP Size.....600 Wp
Storage tank size.....	30.....m <sup>3</sup>
Economic information	
Interest rate.....	Real interest rate...10%
Inflation rate.....	
Costs	
System component 1: SOLAR PUMP	
Investment.....	US \$ 9000
Lifetime.....	15.....years
Annuity.....	13 %
Average annual capital cost.....	\$ 1170
Average annual cost of maintenance and repair.....	\$ 162
System component 2: STORAGE TANK AND PIPING	
Investment.....	US \$ 3618
Lifetime.....	15.....years
Annuity.....	13%
Average annual capital cost.....	\$ 470
Average annual cost of maintenance and repair.....	\$ 36
Annual cost of operation of the system.....	\$ 474
Total annual costs	\$ 2312
Unit water costs	US \$/m <sup>3</sup> 0.42

Table 5.1.b. Format sheet to calculate the unit water cost of a small-scale pumping system. Completed for the example solar pump system, Flamengos, Cape Verde.

The different steps will be described briefly. Tables 5.1.a to c show identical format sheets to note the results, completed for the example used in Chapter 3 (Flamengos, Cape Verde) for: a) wind pumps, b) solar pumps. c) engine-driven pumps. Other examples are given in Appendix D.

## Calculating average annual capital cost (AACC)

The first component of pumping costs is the capital cost, or cost of investment. This cost is incurred once in the lifetime of a pumping installation. In order to make it comparable to recurrent costs, which occur every year, the cost of investment must be converted into an annual capital cost, using the following formula:

$$AACC = ANN \times I$$

with: AACC      annual average capital cost  
ANN      annuity factor  
I      investment

The AACC, annual average capital cost, is a fixed annual amount, covering exactly repayment of capital and interest throughout the lifetime of the investment. The annuity factor ANN depends on both lifetime and interest rate in the following way:

$$ANN = \frac{r}{1 - (1+r)^{-n}}$$

with: r    interest rate  
n    lifetime (years).

For the convenience of the reader, Appendix C contains a table of the annuity factor for various values of interest rate and lifetime.

In order to find the average annual capital costs, the following three factors need to be considered: Investment cost, lifetime, and interest rate.

### Investment cost

The cost of investment for different pumping systems depends primarily on their size as specified in Chapters 3 and 4, i.e. rotor area for wind pumps, peak power for solar pumps, rated power for engine pumps, etc. Section 5.3 presents some typical values of the specific cost, i.e. cost per unit size.

Care must be taken to include the costs of all components of the system. The following must be included:

- Water source (well)
- Power source (wind machine, solar panels, engine, etc.)
- Pump
- Piping

UNIT WATER COST FOR A SMALL-SCALE PUMPING SYSTEM	
System description	
Location..... <i>FLAMENGOS, CAPE VERDE</i> .....	
Design month..... <i>7</i> .....	Design month pumping requirement..... <i>15</i> .....m <sup>3</sup> /day
Total head.... <i>24</i> .....m	Design month hydraulic power requirement..... <i>41</i> .....W
Annual water requirement. <i>5475</i> .....m <sup>3</sup>	
Power source. <i>DIESEL PUMP</i> .....	Size..... <i>2.5 kW</i> .....
Storage tank size..... <i>30</i> .....m <sup>3</sup>	
Economic information	
Interest rate.....	Real interest rate.. <i>10%</i> .....
Inflation rate.....	
Costs	
System component 1: <i>DIESEL PUMP</i> .....	
Investment... <i>US \$ 2500</i> .....	
Lifetime..... <i>7</i> .....years	
Annuity..... <i>21%</i> .....	
Average annual capital cost.....	<i>\$ 525</i> .....
Average annual cost of maintenance and repair.....	<i>\$ 438</i> .....
System component 2: <i>STORAGE TANK AND PIPING</i> .....	
Investment... <i>US \$ 3618</i> .....	
Lifetime..... <i>15</i> .....years	
Annuity..... <i>13%</i> .....	
Average annual capital cost.....	<i>\$ 470</i> .....
Average annual cost of maintenance and repair.....	<i>\$ 36</i> .....
Annual cost of operation of the system.....	<i>\$ 839</i> .....
Total annual costs	<i>\$ 2308</i>
Unit water costs	<i>US \$/m<sup>3</sup> 0.42</i>

Table 5.1.c. Format sheet to calculate the unit water cost of a small-scale pumping system. Completed for the example diesel pump system, Flamengos, Cape Verde.

- Storage tank
- Distribution network
- Field application system (in case of irrigation)

If amounts of useful water pumped are equal for different systems, one may compare the cost of pumping only, leaving common costs (water source, piping, etc.) out of consideration .

Other cost aspects include:

- Purchase (or manufacture)
- Packing, transport
- Site preparation, installation
- Overhead cost (management, secretarial costs)

For the example system the cost of the water source is not included, since an abandoned well was used, for which it was difficult to assess a value.

The cost of investment given for the windmill is the total cost including purchase and installation, in 1983 (reference 23): US \$ 4943.

The cost of investment for the storage tank and the piping is an estimate based on experience constructing similar tanks. Since they are made of heavy masonry they are relatively expensive: total US \$ 3618.

For the solar pump to be applied in the example case (600 W peak power) the cost was assumed to be US \$ 15/pW, for a total of US \$ 9000.

The cost of the diesel pump (2.5 kW engine), with deepwell turbine pump, suitable for the example, is approximately US \$ 2500. A storage tank is included with the diesel pump since the use of a storage tank is common practice in water supply schemes.

### **Lifetime**

Realistic lifetimes must be used. Even if the (technical) lifetime of an installation is very long (e.g. 30 years for a concrete foundation), one must use a shorter (economic) lifetime, representing the period during which the installation will be effectively used (e.g. 15 years for a foundation). In 30 years' time circumstances may have changed and different solutions for water supply may have been found (such as a central pumping station with a piped distribution).

Different components of an installation may have different lifetimes. In that case the average annual capital cost must be determined for each component separately, and the annual costs added together.

The format sheet in Table 5.1, Chapter 5 has space to deal with two different lifetimes. If necessary, one may continue the format sheet using longer or shorter lifetimes than those given. Some general indications of typical lifetimes are given in Section 5.3.

In the example, a lifetime of 10 years was selected for the wind pump, which is a conservative estimate.



Many storage tanks of the type used in the example are over 25 years old. However, an economic life of 15 years was estimated for the tank.

An economic life of 15 years was assumed for the solar pump, and 7 years for the diesel pump, corresponding to 10,000 hours of operation at 4 hours a day.

### **Interest rate**

The real interest rate, interest corrected for inflation, must be applied. In a first approximation (if both rates are small) this is equal to the difference of both rates. Care must be taken to apply a realistic rate of interest. Even if the official bank rate is low, capital may be so scarce that it is in fact only available at a much higher rate. A typical value, often used in general assessments, is 10%. The value of 10% was used in the example.

## **Calculating annual recurrent costs (ARC)**

Recurrent costs are considered to consist of two parts: maintenance and repair costs, and costs of operation.

### **Maintenance and repair costs**

Depending on the character of the maintenance and repair activities to be carried out, one may distinguish three types of maintenance and repair costs:

- o A constant annual amount, more or less independent of the size of the installation, reflecting for example a regular inspection visit to each installation (monthly, yearly). This type of cost is a component of the maintenance and repair cost of most types of pumping systems.
- o An annual amount proportional to the initial investment. This is the most important component of maintenance and repair costs of wind pumps and solar pumps. The time to be spent on maintenance and repair and the cost of spare parts is related to the size of the installation, which in its turn is related to the investment.
- o An amount proportional to the time of operation, which is typical for engine-driven pumps. For example, these pumps need maintenance after 1,000 running hours and overhaul after 8,000 hours. In contrast, for both wind and solar pumps the time of operation has little influence on the costs of maintenance and repair.

Section 5.3 gives some typical values of maintenance and repair costs of different types of pumping systems.

In the example, Table 5.1, the cost of maintenance and repair of the wind pump is indicated to be US \$ 200, which is 3% of the investment plus a fixed sum of US \$ 50 per year. In practice even lower costs were observed of around US \$ 160 per year (reference 23). The cost of maintenance and repair of the storage tank is very low; here a value of 1% of the investment was taken. For the solar pump the costs of maintenance and repair were taken from Table 5.5, resulting in an annual cost of US \$ 162. For the diesel pump these costs were assumed to be US \$ 300 per 1000 running hours, or US \$ 438 per year.

### Operating costs

For the different water pumping systems different types of operating costs are to be taken into account:

**Wind and solar pumps:** The cost of operation is mainly related to salaries for attendance, operation of the pump, and water distribution.

**Fuel pumps:** Here the fuel cost is the main cost of operation. Also salary costs are to be taken into account for attendance, starting and stopping the motor, and water distribution.

**Animal traction pumps:** The cost of feeding the animal(s) is the main cost of operation.

**Hand pumps:** Especially for irrigation the cost of labor is to be taken into account in some way or another, as the same labor could be used for more profitable purposes such as hoeing or applying fertilizer.

In the example, the cost of one year's salary of a watchman/operator was taken as the annual cost of operation for all types of pumps.

For the diesel pump, the cost of fuel has to be added. The fuel consumption of the engine-driven pump set defined in Section 4.4.3, Chapter 4 is approximately 0.5 l/hr (field value), corresponding to an efficiency of 13%. Assuming a cost of fuel of US \$ 0.50/l the total cost is estimated at US \$ 365.

## Calculating unit water costs

The unit water cost may be found by dividing the total average annual cost by the total annual water requirement. The total average annual cost is simply the sum of the average annual capital cost and the annual recurrent costs (steps 6 and 7):

$$AAC = AACC + ARC$$

with: AAC        average annual cost  
      AACC        average annual capital cost  
      ARC        annual recurrent cost.

For the example case one finds the following results:

Wind pump	US \$ 0.36/m <sup>3</sup>
Solar pump	US \$ 0.42/m <sup>3</sup>
Diesel pump	US \$ 0.42/m <sup>3</sup>

In a thorough analysis one should not end here, but investigate the influence of all uncertain assumptions on the results, i.e. carry out a sensitivity analysis.

As an example the influence of the interest rate will be investigated. By taking an interest rate of 15% instead of 10%, the results become as follows:

Wind pump	US \$ 0.43/m <sup>3</sup>	an increase of	20%
Solar pump	US \$ 0.51/m <sup>3</sup>	an increase of	21%
Diesel pump	US \$ 0.46/m <sup>3</sup>	an increase of	10%

One clearly sees that a change of interest rate changes the comparative costs. Wind and solar pumps are more sensitive to the interest rate than the diesel pump.

Wind pumps are found to be more cost effective than engine pumps due to several special conditions in the case of this example for Cape Verde: The example concerns a tubewell of low capacity; in this case a relatively expensive turbine pump with diesel engine is needed, which is not available in a small size. The larger-size, more costly pump would be under-utilized. Moreover practice in Cape Verde shows that the same type of expensive storage tanks are used for both engine pumps and wind pumps. Wind pumps are typically used for deep tubewells of low capacity.



*Low lift irrigation in Sri Lanka with a 3 m wind pump (background) designed and manufactured by the Wind Energy Unit of the Water Resources Board with assistance of CWD, Holland.*

### 5.3. General data on costs

This section presents information on typical costs, which may be applied to the procedure outlined in Chapter 4. It is based as much as possible on real costs, for which references are indicated. The information is presented as specific costs, i.e. costs per unit size of installation (e.g. per unit rotor area for windmills, per unit rated power for engine pumps).

#### 5.3.1. Data on wind pump costs

The main characteristic of a wind pump, as stated before, is its rotor area. The output performance and the costs of the pump (both capital and recurrent) depend primarily on the size of the rotor.

##### Investment costs

An extensive inventorization of wind pump prices was made in 1983 by IT Power for the World Bank and UNDP (reference 2). A wide variety of prices was found. This information is presented in a somewhat simplified form in Figure 5.1. It covers most of the data given in reference 2, leaving out extremes.

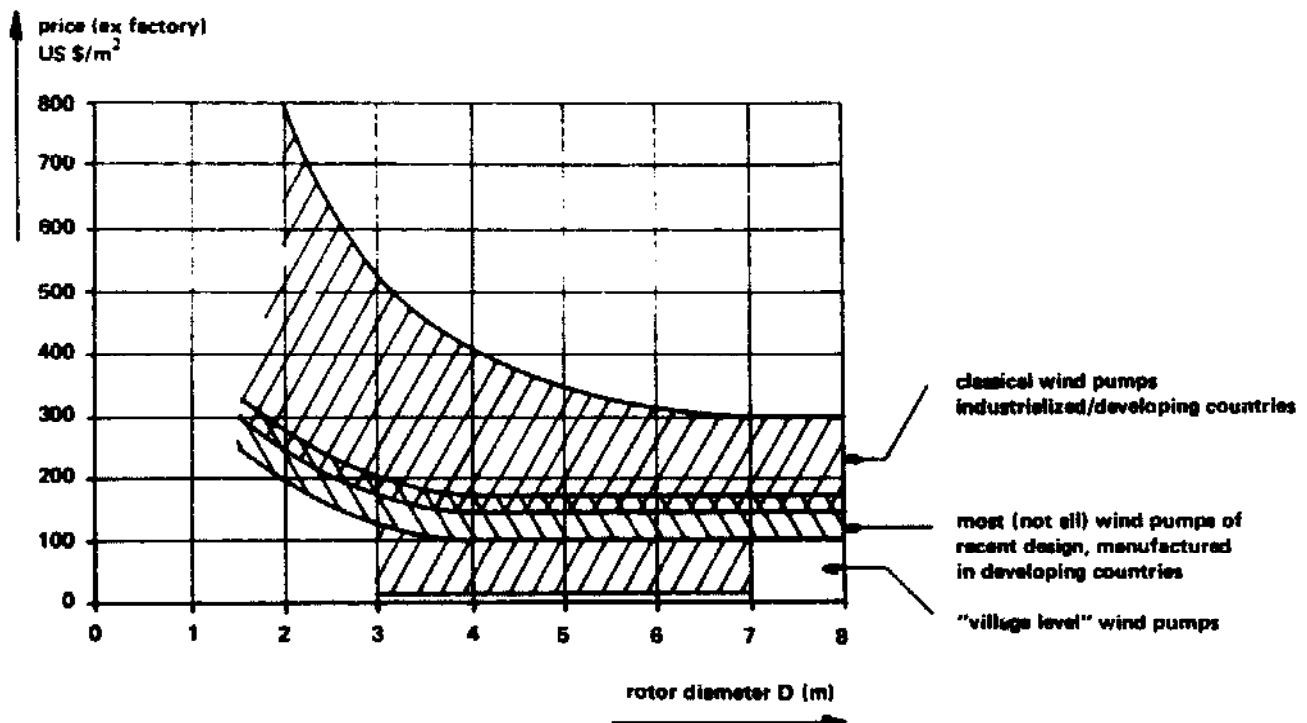

Figure 5.1. Prices (ex factory) of wind pumps, based on information given in reference 2 (1983).

One sees that most wind pumps cost from US \$ 150 to US \$ 300 per  $m^2$  of rotor area. At the lower end of the scale the cost per  $m^2$  is somewhat higher. This category includes machines manufactured in both industrialized and developing countries. Most, but not all, machines of recent design produced in developing countries have a somewhat lower cost: US \$ 100 to US \$ 150 per  $m^2$ . Some, but not all, classical machines manufactured in the United States are considerably more expensive: US \$ 500 to US \$ 600 per  $m^2$ , or up to US \$ 800 per  $m^2$  for very small sizes.

At the bottom end of the scale one finds "village level" wind pumps. These are machines manufactured from materials available in rural areas, such as wood and sail cloth. The low investment costs, US \$ 10 to US \$ 100 per  $m^2$ , are somewhat misleading as this kind of machine requires major repairs every week and a complete overhaul every season or so. The applicability of this type of machine depends mainly on the willingness of villagers to be dependent on a technology that constantly requires repairs. It can only be expected to be successful in exceptional cases.

Due to large differences in labor and material costs in different countries for the production of similar types of wind pumps, Figure 5.1 shows a broad variation of prices. Another indicator that distinguishes different types of wind pumps more clearly is their weight. Using the same set of data from which Figure 5.1 was derived (reference 2), the specific weights were calculated (i.e. the total weight per unit rotor area). These are presented in Figure 5.2 (taken from reference 27). Using weight as a criterion, a clear distinction is visible between classical and innovative wind pumps.

The final, total costs of the machines will depend on the costs of material (mostly steel), and the costs of processing it. Of course, these costs are specific to a country or even a region. In countries which have to import steel products the costs of material will be relatively high, and often include import taxes. Cost of processing will be high both in countries with high salaries and in countries with a weak infrastructure (which makes industrial enterprise less efficient). Typical values of the cost per unit weight of complete windmills were derived from reference 2 and are indicated in Table 5.2.

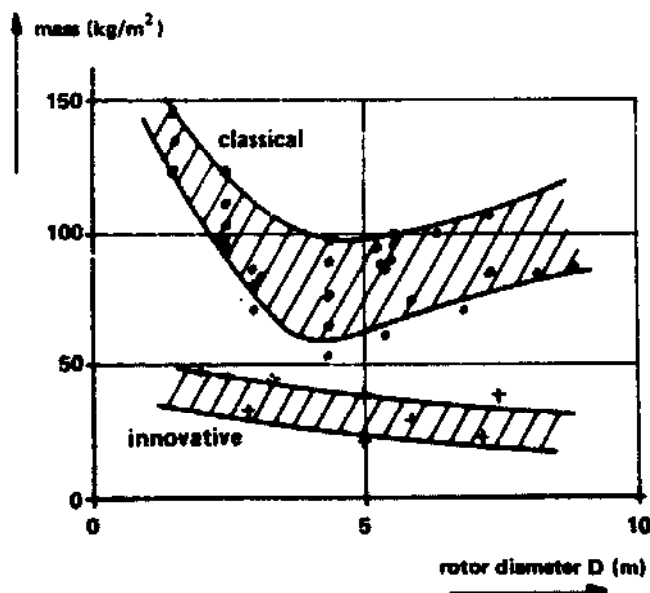

Figure 5.2.  
Trends in specific mass ( $kg/m^2$  rotor area) of classical multiblade and modern design wind pumps.  
Note: values have not been corrected for tower height and pumping depth, but the trend seems sufficiently clear (reference 27).

The information on investment costs presented so far relates to prices *ex factory*. Other costs are important too, such as transport and installation. Table 5.3 presents a tentative breakdown of wind pump cost components. The three main components of a wind pump itself are distinguished. The table refers to classical wind pumps.

### Outlook for the future

An important question concerns the scope for future cost reduction. During the last ten years several innovative wind pump designs have been developed, and some are now entering a phase for dissemination on a larger scale. These machines are much lighter than the classical wind pumps (Figure 5.2) and have a much better performance (Table 2.2). An important issue, of course, is the cost of production per unit weight of the machines (Table 5.2). A potential exists for bringing down these costs by setting up

WIND PUMP COSTS PER UNIT WEIGHT (US \$/kg)		
USA, Europe	most manufacturers	5-6
	some	2-3
Australia, N. Zealand	one manufacturer	1.30-1.50
	other	2.50-4.00
Developing countries	some (e.g. Sri Lanka)	2-3
	other (e.g. Cape Verde)	7-10

Table 5.2. Wind pump costs per unit weight, based on information given in reference 2.

WIND PUMP COST COMPONENTS				
		Small (D=2m)	Medium (D=4m)	Large (D>6m)
Machine (i.e. head, rotor, vane, transmission)		40%	60%	75%
Tower		50%	30%	20%
Pump, pipes		10%	10%	05%
Total price ex factory		100%	100%	100%
Packing, transport:	Local	0 to 5%		
	Overseas	25 to 50%		
Import duties		P.M. (0 to over 100%)		
Installation		5 to 25%		
Total investment cost				
- Local manufacture		110 to 130% of price ex factory		
- Import		130 to 175% of price ex factory plus import duties		

Table 5.3. Approximative cost components of classical wind pumps in percentages. The price ex factory has been taken as 100%.

series production in developing countries. Altogether the pumping cost attributed to the wind pump itself may decrease by a factor of 2 to 4. This would make wind pumping more advantageous as compared to other means of pumping water.

### **Lifetime**

The lifetime of a wind pump depends not only on the technology but also on the quality of maintenance and repairs. Cases are known of wind pumps over 40 years old which are still fully operational. Of course, 40 years is not a realistic (economic) lifetime. Reasonable lifetimes are 15 years for classical windmills and 10 years for recent, light-weight wind pumps.

### **Maintenance and repair costs**

Hardly any systematic information is available on costs of maintenance and repair of wind pumps. These costs depend strongly on the specific situation: How is maintenance organized, is it done by the owner, or by a central agency? Do large distances have to be covered by maintenance personnel? It also depends on the physical environment. In unfavorable climates with a lot of sand or salt in the air, regular cleaning and annual painting may be absolutely necessary, even for galvanized steel.

Again these costs depend on the size of the wind pump. The cost of spare parts depends on the size, as does the time needed for repair. However, for very small sizes the costs will be relatively higher, since part of the cost does not depend on size, especially the cost of travel to and from the installation. A reasonable, general assumption for maintenance and repair costs would seem to be 3% to 5% of the investment per year, plus a fixed sum of US \$ 50.

### **Cost of operation**

The cost of operation of a wind pump is mainly the cost of attendance. Again, the amount of the cost depends strongly on the specific situation. In the case of a windmill used for irrigation on a small farm, the cost of operation of the windmill is practically zero, since it is part of the regular work on the farm. In the case of a wind pump incorporated in a rural water supply scheme that is managed by a central authority, the salary of an attendant must be paid. Often, this same attendant will be responsible for distribution and sale of the water, meaning that part of the overall cost may be attributed to distribution instead of pumping.

### Cost of storage

An essential part of a wind pump system is a storage tank. Table 5.4 presents some guidelines on costs of storage tanks.

STORAGE TANK COST ASPECTS			
	Investment cost (\$ per m <sup>3</sup> of storage)	Lifetime (years)	Annual maintenance (% of investment)
Simple technology: Earth bund, low head	\$ 10 - \$ 20	10	5%
High technology: Steel, concrete overhead storage	\$ 50 - \$ 100	30	1%

Table 5.4. Approximative cost aspects of storage tanks.

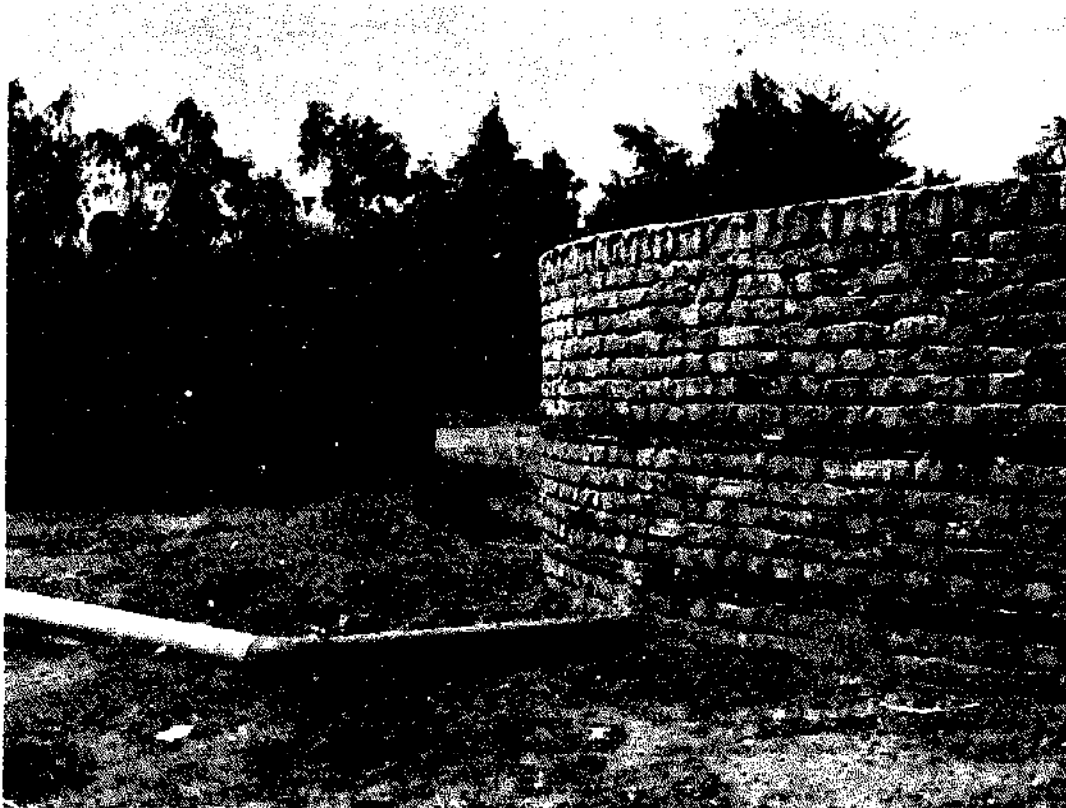

*A storage tank adds considerably to the costs of a pumping system. The tank on the left has cracks in the outer wall. The tank on the right has been reinforced with steel straps.*



Cost component	Engine		Wind	Solar	Hand	Animal
	Diesel	Petrol, Kerosene				
<b>Total investment</b> (incl. installation)	US\$ 600 per kW rated engine power Smallest practice size: 2.5 kW	US\$ 400 per kW rated engine power Sizes: 0.5 - 10 kW	Cost/m <sup>2</sup> of swept rotor area: Classical: US\$ 400/m <sup>2</sup> Innovative: US\$ 200/m <sup>2</sup> Diameter sizes: 1 to 8 m Larger sizes: electrical systems: US\$ 200/m <sup>2</sup>	Cost/peak power output (i.e. output in full sunshine H = 1000 W/m <sup>2</sup> ) Present: US\$ 12-18/W <sub>p</sub> Future: US\$ 8-13/W <sub>p</sub> Long term: US\$ 5-10/W <sub>p</sub>	US\$ 200 - 300 per pump	US\$ 250 per animal
<b>Lifetime</b>	10,000 oper.hrs	5,000 oper.hrs	10 to 15 years	15 years	5 years	5 years
<b>Maintenance + repair</b> - Fixed annual cost - Cost/1000 oper.hrs - Annual cost as % of investment -Add for total cost !	- US\$ 200 - 400 - -	- US\$ 200 - 400 - -	US\$ 50 - 3%-5%	US\$ 50 US\$ 12 1%	US\$ 10 - -	US\$ 10 - -
<b>Operating cost</b> - Fuel - Operator/watchman	US\$ 0.35 - 0.70/ltr US\$ 1 - 10/day	US\$ 0.35 - 0.70/ltr US\$ 1 - 10/day	- US\$ 1-10/day	- US\$ 1-10/day	- US\$ 1-10 per person per day	- US\$ 2.25 per animal / day
<b>Output performance</b>	Overall efficiency $\eta_{tot} = 10\%$ Fuel energy contents: 10 kWh/liter Derating (= power demanded by pump over rated engine power): r = 0.50 Efficiency of pump and lines $\eta_{p,l}$ low: 30% medium: 40% high: 50%	Overall efficiency $\eta_{tot} = 5\%$ low: 30% medium: 40% high: 50%	$\beta = P/AV^3$ P: avg. hydr. power (W) A: rotor area (m <sup>2</sup> ) $A \approx \pi/4 D^2$ V: average wind speed in design month $\beta$ : low: 0.05 medium: 0.10 high: 0.15 electrical systems 0.06	Average daily energy sub-system efficiency (total daily hydraulic energy output, over total energy delivered by the solar panels) <sup>1</sup> low: 25% medium 35% high: 45% (see Table 4.1)	Typical hydr. power output: $P_{hydr}=30 W$	Typical hydraulic output per animal: $P_{hydr}=200 W$
<b>Use and application</b> - Rural water supply -Irrigation	6 - 12 oper.hrs/day 365 days/year 100 days/year	2 - 6 oper.hrs/day 365 days/year 100 days/year	Hydraulic power demand in critical month Annual average hydraulic power demand 1 3	1-12 hrs/day 365 days/year 100 days/year	4-12 hrs/day 365 days/year 100 days/year	

Table 5.5. General (approximative) cost aspect of small-scale pumping systems. The data indicated are based on a variety of references and general field experience (for storage tanks see Table 5.5).

<sup>1</sup> corresponding overall efficiencies; approximately 2.5 to 6% (see also Section 4.4.2, Chapter 4).

### 5.3.2. Costs of other pumping systems

Table 5.5 presents typical information on various cost aspects of small-scale pumping systems. It also gives information on output performance, which influences the unit cost of water. The unit cost of water also varies according to the type of application it will be used for (irrigation or rural water supply) owing to the different demand patterns.

An underlying assumption when drafting the table was that sufficient attention will be paid to operation, maintenance and repair. In many practical situations one encounters very short lifetimes and reduced output of engine-driven pumps due to lack of proper maintenance of the equipment. It would not be fair to assume a long life and high output for wind and solar pumps, as they may also suffer from inadequate maintenance and repair.

A sound comparison of technologies must be based on the assumption that all technologies under consideration are well used and are exploited to a reasonable degree of their potential.

Table 5.5 comprises the categories of information needed to perform the cost comparison procedure as described in Section 5.2. It may also be used in combination with the explicit equations of Appendix C for calculating the specific costs directly (i.e. cost per unit of useful hydraulic energy produced), as will be discussed in more detail in Section 5.4.

Operating costs for hand pumps depend on the cost attributed to local labor. This cost is rather difficult to assess, since it is often not reflected in any kind of payment. A similar problem occurs with animal-driven pumps. The data indicated in the table are based on a variety of sources, and general field experience. The data for engine-driven pumps are based on references 1, 2, 13, 18, 22 and 25a.

Cost aspects of wind pumps have been treated in more detail in Section 5.3.1. The information on solar, hand and animal-driven pumps is based mostly on the solar handbook (reference 1).

Reliable data on costs of operation and maintenance are extremely limited for all methods of pumping, including engine-driven pumps. The data presented in Table 5.5 is useful for the purpose of making comparisons between different pumping systems, but in specific situations information on actual costs must be collected.

## 5.4. General comparison of unit water costs for different small-scale water pumping techniques

An idea of the current and future water costs of wind pumps, when compared to fuel and solar pumps, can be obtained from Figures 5.3.a and 5.3.b. The figures have been prepared, using the equations presented in Appendix C, which are basically the same as those used in the cost comparison procedure presented in Section 5.2.

In the figures the unit water cost related to the pumping system (i.e. excluding water source, storage, and distribution) is indicated as cost per unit of hydraulic energy, and is shown as a function of the annual average pumping requirement per day. On both axes different units are indicated. Energy may be expressed either as kWh hydraulic, or as  $m^4$  (i.e. volume of water in  $m^3$  times head in m, see Section 1.2, Chapter 1).

The graphs are based on the data given in Table 5.5. However, inclusion of the complete ranges of all parameters indicated in the table would tend to fill the graph completely with very wide bands of cost curves, and the distinction between the technologies would be lost. Therefore some assumptions were made for the different technologies. In a situation where these assumptions are not valid, a new set of graphs may be drawn, using the equations in Appendix C and the blank graph paper in Appendix E. The assumptions made here are the following:

### Engine-driven pumps

<u>Investment:</u>	For very small water requirements it was assumed that the smallest available size of engine is used. If, for large water requirements, a larger pump set is needed than the largest available gasoline pump, it was assumed that more pumps will be used. This is realistic for suction pumps. However, if the pump is to be installed on a tubewell, this would imply additional tubewells, which is not realistic.
<u>Lifetime:</u>	According to Table 5.5 and number of hours of operation, see below (use and application).
<u>Maintenance and repair:</u>	Both values of Table 5.5 are included in the range indicated in the figure.
<u>Operating cost:</u>	Fuel US \$ 0.35 - 0.70 per liter; the band in the figure covers both values. Operator: zero (this cost is difficult to assess and in any case similar for different technologies).
<u>Output performance:</u>	According to Table 5.5 with efficiency of pump and lines of 40%.
<u>Use and application:</u>	Diesel: 2000 hours per year. For 365 days of operation this means 5.5 hours per day. Kerosene/gasoline: 1000 hours per year. For 365 days of operation this means 2.75 hours of operation per day. For very small water requirements, where the smallest available size is used, the number of hours of operation is reduced according to the requirement.

## Wind pumps

<u>Investment:</u>	Classical: US \$ 400/m <sup>2</sup> (total, including transport, installation). Future: US \$ 200/m <sup>2</sup> For very small water requirements it was assumed that very small wind pumps are available, down to 1 m diameter. For large water requirements, requiring a wind machine larger than 8 m diameter, it was assumed that electrical systems are used, at the same specific investment cost.
<u>Lifetime:</u>	15 years.
<u>Maintenance:</u>	Present: 5%, Future: 3%, Fixed annual cost: US \$ 50
<u>Operating cost:</u>	Zero (this cost is difficult to assess and similar for different technologies).
<u>Output performance:</u>	Quality factor $\beta = P/AV^3$ : classical: $\beta = 0.08$ , future: $\beta = 0.15$ (see Table 2.2, Chapter 2).
<u>Use and application:</u>	Ratio of hydraulic power demand in design month to annual average hydraulic power demand: 1.

Note that the wind speed indicated in the figure is the wind speed in the design month.

## Solar pumps

<u>Investment:</u>	Present: US \$ 18/W <sub>p</sub> , Future: US \$ 9/W <sub>p</sub> , Long term: US \$ 6/W <sub>p</sub>
<u>Lifetime:</u>	15 years
<u>Maintenance and repair:</u>	See Table 5.5
<u>Operating cost:</u>	Zero (this cost is difficult to assess and anyhow similar for different technologies).
<u>Output performance:</u>	Average daily energy subsystem efficiency: $\eta_s = 40\%$ .
<u>Use and application:</u>	Ratio of hydraulic power demand in design month and annual average hydraulic power demand: 1.

The irradiation in the design month was assumed to be 4 kWh/m<sup>2</sup>/day, or 14 MJ/m<sup>2</sup>/day.

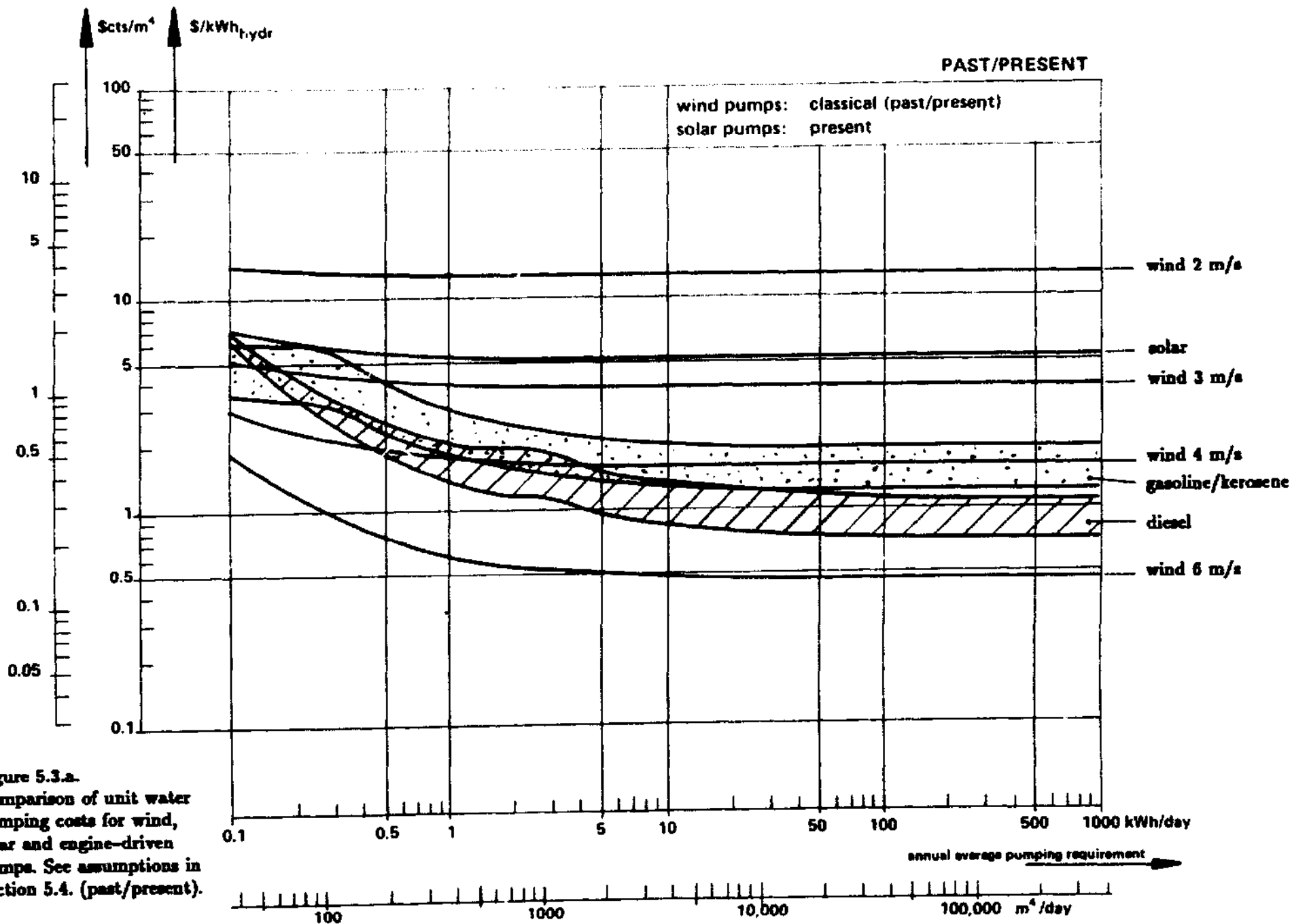
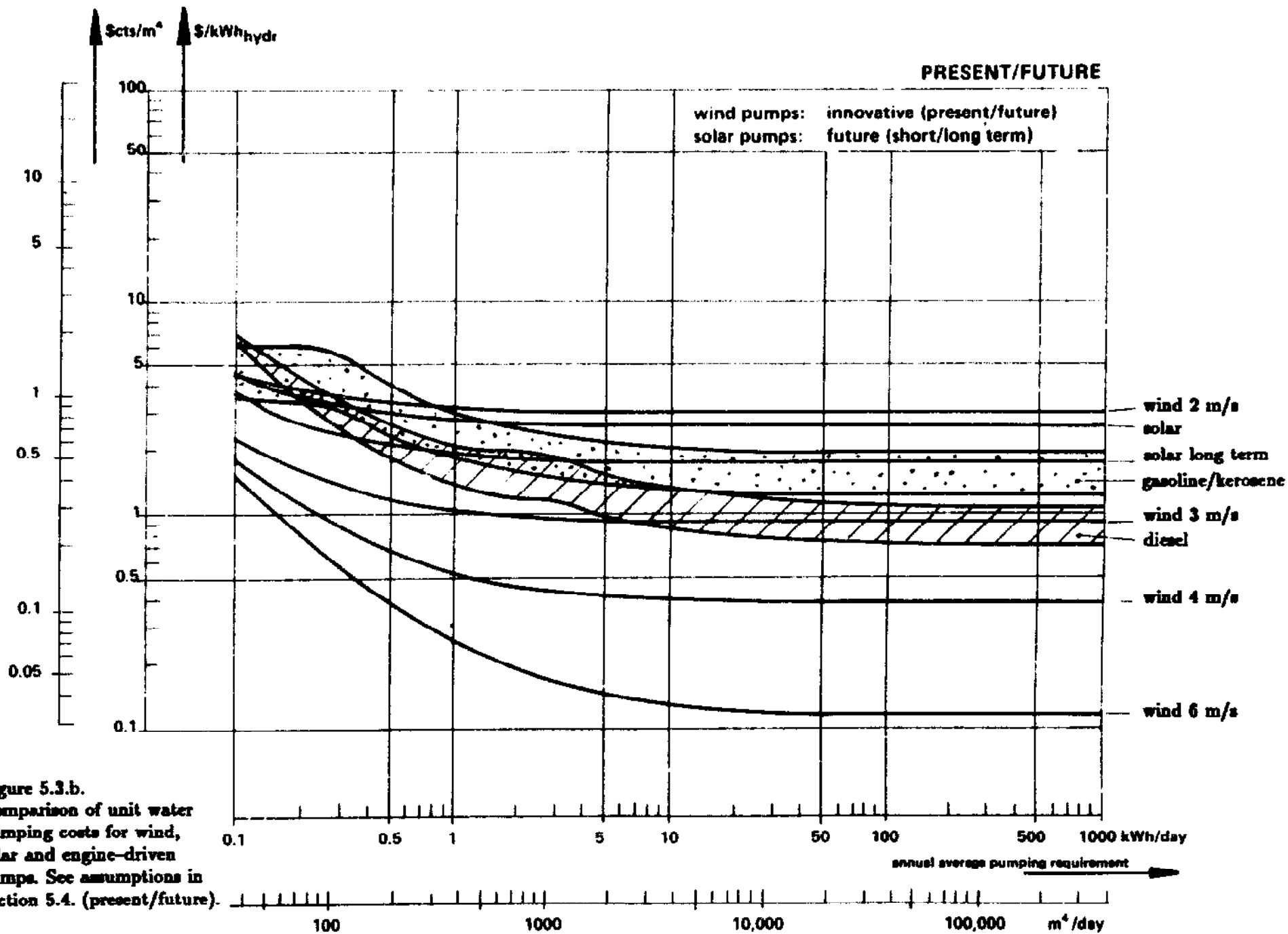

Figure 5.3.a. Comparison of unit water pumping costs for wind, solar and engine-driven pumps. See assumptions in Section 5.4. (past/present).

Note: Graphs are based on average values of investment costs, fuel costs, etc. Always make your own calculations based on prevailing costs in your situation.



**Figure 5.3.b.**  
Comparison of unit water pumping costs for wind, solar and engine-driven pumps. See assumptions in Section 5.4. (present/future).

**Note:**  
Graphs are based on average values of investment costs, fuel costs, etc. Always make your own calculations based on prevailing costs in your situation.

## Concluding remarks

This chapter has presented a methodology for cost comparison of small-scale water lifting devices. Typical costs were indicated for engine pumps, wind pumps, and solar pumps. Finally, a generalized cost comparison was presented (on the basis of more or less average or typical assumptions) in Figures 5.3.a and 5.3.b. These figures illustrate much of what was indicated in a qualitative way in Chapter 1 of this handbook.

**Engine-driven pumps.** A range of costs is indicated, corresponding to uncertainties in cost of fuel, and of maintenance and repair. Since engine pumps are a well-established technology, which does not change very rapidly, identical ranges are indicated for past/present/future.

The cost of pumping water decreases with increasing demand as can be expected owing to economy of scale.

The curves show bulges, which are due to the way in which the assumptions were made (see previous pages). For practical purposes the bulges may be disregarded and a smoother decrease of costs may be assumed.

The bulges in the graphs are somewhat academic. They are related to the minimum engine size practically available. It was assumed that the smallest gasoline or kerosene engine has an output power rating of 0.5 kW, and the smallest diesel engine a rating of 2.5 kW. At pumping requirements below 500 and 2000 m<sup>3</sup>/day respectively, the smallest available engine size is used and operated during a reduced number of hours. As a consequence the unit capital costs increase because an oversized pump is used, but decrease due to a prolonged life (lower annuity factor). The combination of these two factors causes the bulges in the graphs (see equation C.10 in Appendix C).

The diesel engine pump is the most cost effective of engine-driven pumps, except for small pumping requirements, roughly below 500 m<sup>3</sup>/day, where kerosene and gasoline pumps become competitive.

**Wind pumps.** For the two sets of curves "past/present" and "present/future" different values were assumed for output performance and investment costs. "Past/present" refers to classical wind pumps. Although "present/future" refers to a few modern designs now in development, it basically points to future developments. Most modern wind pumps will for the time being lie in between the two sets of curves.

The graphs clearly show the strong dependence on wind speed.

The economy of scale is less strong for wind pumps than for engine-driven pumps. Going from right to left, wind pumping becomes increasingly economic in relation to engine pumping: some of the wind pump lines lying within the engine range on the right side pass below the engine range at the left side.

The figures illustrate the tendencies indicated in Section 1.6, Chapter 1:

- o Wind energy is the best option if the wind speeds in the critical month exceed 5 m/s.
- o Below 2 m/s in the critical month, wind energy for water pumping is generally not economically feasible.
- o Wind pumps are especially attractive at low hydraulic power requirements.

**Solar pumps.** Three different curves are indicated corresponding to different costs of solar PV panels: present, future and future long-term.

The economy of scale is again less pronounced than for wind pumps, and at very small pumping requirements it becomes worthwhile to consider solar pumps as an alternative to wind pumps, say below 500 m<sup>4</sup>/day, as indicated in Table 1.2 in Chapter 1.

#### **Validity of graphs**

It should again be stressed that the assumptions on which these graphs were based are not necessarily valid in a specific region or country. The reader is therefore advised to check all assumptions for his specific situation and with the instruments given in this publication to make his own calculations.

The examples used in the main text and in Appendix D illustrate this point. The examples are much more favorable for wind pumps than the general graphs (Figure 5.3) would suggest. In general, when other data are not available, the graphs should be used for a conservative approach. (Of course it is also possible to identify examples which are far less favorable for wind pumps).



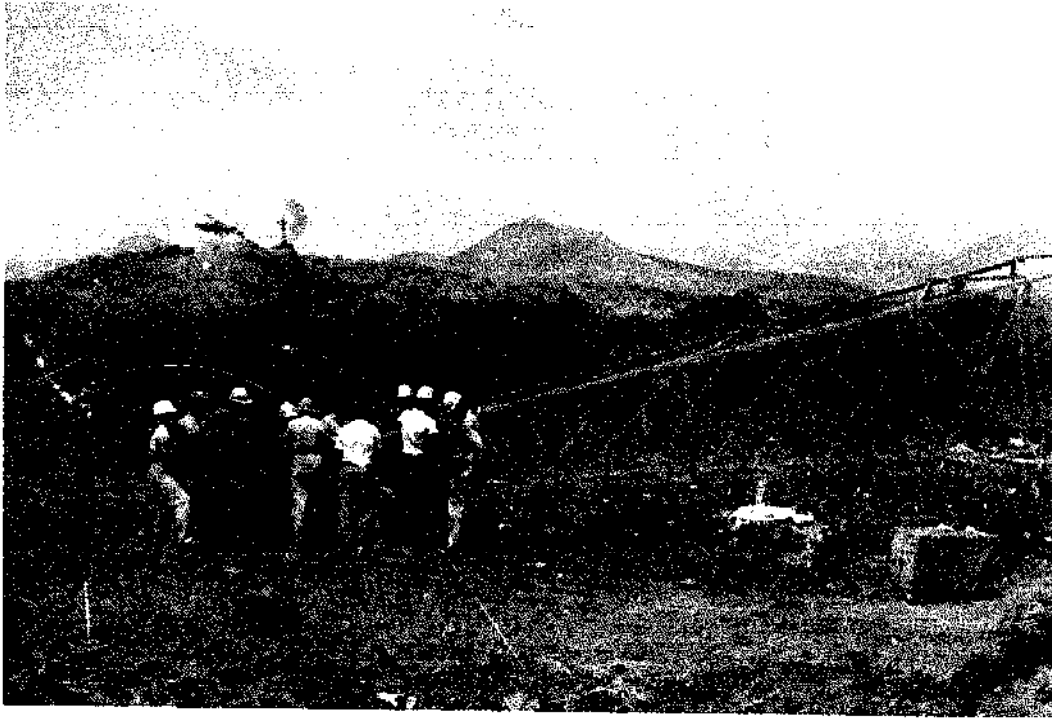

*Installation of wind pump on Cape Verde.*



*This bogged-down tank truck in the state of Maranhao, Brazil, illustrates a favorable logistic aspect of wind pumps: independence of fuel supply.*

## Chapter 6

# LOGISTICS AND SUPPORTING ACTIVITIES

This chapter will be most useful to managers of large-scale wind pumping projects, as it describes the complete range of activities needed for implementing such projects. Readers who intend to purchase only one or two pumps, or who are interested in local manufacture and distribution of wind pumps will find that much of the material covered does not apply to their situation. However, it is useful to read the chapter to obtain an overview of what is involved in managing a wind pump installation. The section on operation and maintenance is of general interest, and should not be skipped.

Section 6.1 describes the steps to follow in specification and procurement of a wind pump. The option of local manufacture is also touched on briefly. Section 6.2 discusses installation, operation and maintenance. Section 6.3, of special interest to rural extension services, donor agencies, and managers of large-scale projects, discusses monitoring and evaluation. Section 6.4 details manpower and training requirements for installation of large numbers of wind pumps.

### 6.1. Procurement

This section describes a series of steps to be followed for the procurement of wind pumps. It will depend on the situation whether it is really necessary to follow all steps of the procedure. For small orders one may combine some of the steps, or just use the description presented here as a checklist of aspects to be taken into consideration.

The procurement procedure described below was developed by the World Bank/UNDP Global Solar Pumping Project, implemented by IT Power and Halcrow and partners, and published in the solar pumping handbook (reference 1). With some minor modifications it has proved to be very suitable for wind pumps.

Five stages for the specification and procurement of a wind pump are recommended:

- o **Assess wind pumping viability and estimate costs.**  
Before contacting suppliers, an initial appraisal of wind pumping should be made in accordance with the guidelines given in Chapters 1 and 3, including a preliminary choice of rotor diameter.
- o **Prepare tender documents.**  
A suggested format for tender documents is given in Appendix F.

- o **Issue a call for tenders.**  
Letters may be sent to suppliers with a brief description of the required system. Interested suppliers will then reply with a request for the tender documents.
- o **Preliminary evaluation.**  
Each tender should be checked to ensure that:
  - a. the system being offered is complete, and includes spare parts and installation and operating instructions;
  - b. the system being offered can be delivered within the maximum period specified; and
  - c. that an appropriate warranty can be provided.
- o **Detailed assessment.**  
A detailed assessment of each tender should be made under the following four headings with approximately equal importance ascribed to each heading:
  - a. **Compliance with specification**  
The output of the system should be assessed taking into account any deviations from the specification proposed by the tenderer.
  - b. **System design**  
The suitability of the equipment for the intended use should be assessed taking into account operation and maintenance requirements, general complexity, safety features etc.  
  
The equipment life should be assessed with regard to safety system, bearings, and other parts liable to wear and tear.  
  
The content of the information supplied to support the tender should be assessed, in particular the provision of general assembly drawings and performance information.
  - c. **Capital cost**  
Capital costs should be compared, allowing for any deviations from the specification proposed by the tenderer. This can be done by comparing the capital cost per unit of hydraulic energy delivered by the system. Also the cost per unit of rotor area is a useful quantity. However, additional calculations are needed to determine the useful output and the cost of pumping, as described in Chapter 5.
  - d. **Overall credibility of tender**  
The experience and resources of the tenderer relevant to wind pumping technology in developing countries should be assessed together with the tenderer's ability to provide a repair and spare parts service should problems be experienced with the wind pump. A reasonable warranty, at least relating to spare parts, should be provided.

A more elaborate procedure for organizing a call for tenders has been established by the FIDIC, International Federation of Consulting Engineers (reference 16a). As it was developed for large civil engineering projects, it is not very suitable for the procurement of wind pumps. However, it may be a useful guideline when subcontracting projects requiring large numbers of wind pumps.

### 6.1.1. Local manufacture – an interesting alternative

Local production of wind pumps may be an interesting option for many countries/regions. Before starting any such activity, however, one must consider carefully its feasibility. It is especially important to estimate as accurately as possible the size of the potential market for wind pumps. It does not make sense to start a production facility to manufacture just a few dozen pumps.

The difficulty in setting up any scheme for local production must not be underestimated. A reliable design must be used of a size and type appropriate for local conditions, one that can be manufactured locally, and for which local materials are available and obtainable at a reasonable price. A production and sales organization must be set up, training will be needed at all levels, and quality control is essential.

It is outside the scope of this handbook to treat in detail all aspects of local manufacture of wind pumps. Anyone interested in local production may wish to consult one or two case studies listed under References (references 18 through 25a).

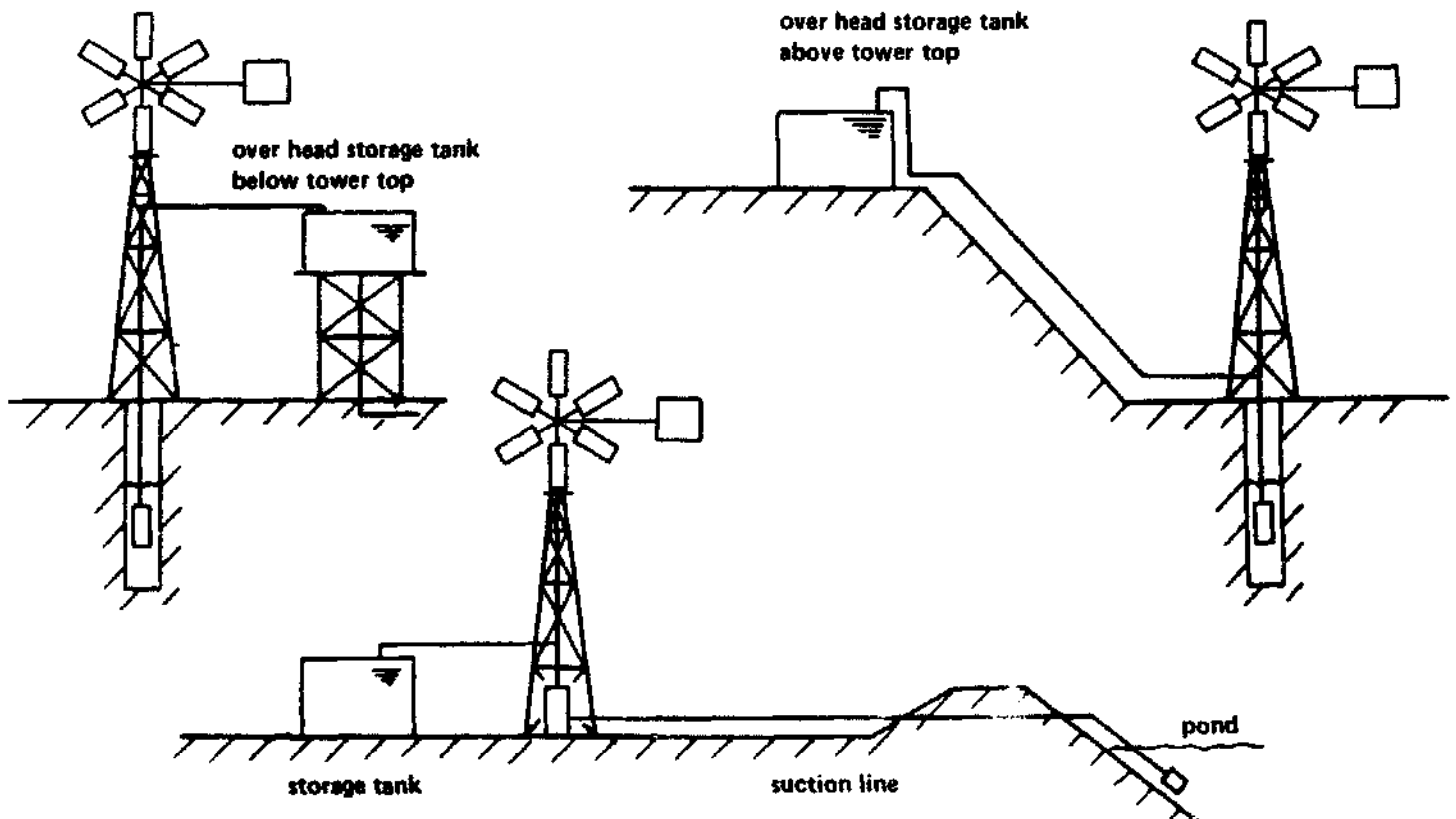

Figure 6.1. Typical wind pump system layouts.

## 6.2. Installation, operation and maintenance

An important reference for this section has been an ILO study on manpower profiles in the wind energy subsector (reference 16). Part of the text of this section consists of direct quotations from that study.

A distinction needs to be made between different types of installations: suction or deep well pumps, installation over a hand dug well or a narrow tubewell, delivery of water at ground level, or pressure delivery. See Figure 6.1 for sketches of some typical system layouts.

### 6.2.1. Installation

#### Site survey

Although a site evaluation may already have been performed (see Chapter 3), the site should be surveyed by the installation company or whatever organization responsible for installation. The following aspects should be considered in such a survey:

- Layout of the installation, and future operation of the installation
- Soil (admissible load by the foundation)
- Brickwork of hand dug well (admissible load)
- Water intake (in case of surface water pumping)
- Logistics (access roads)
- Budget
- Time schedule

#### Civil engineering work

Before the actual installation can be carried out, the civil works should be ready. They consist of the foundations (of concrete) and the storage tank (plastered brickwork, concrete or ferro-cement).

The site and size of the storage have been indicated in the site evaluation. The specifications of the foundations usually will be the same for the same type of machine and will be described in the installation manual, but differences may occur according to the type of soil and size of well. These modifications should also have been indicated in the site survey.

Special attention must be paid to the alignment. The foundation should be made in a way that the tower will be exactly vertical and — in case of a tubewell — centered around the tubewell.

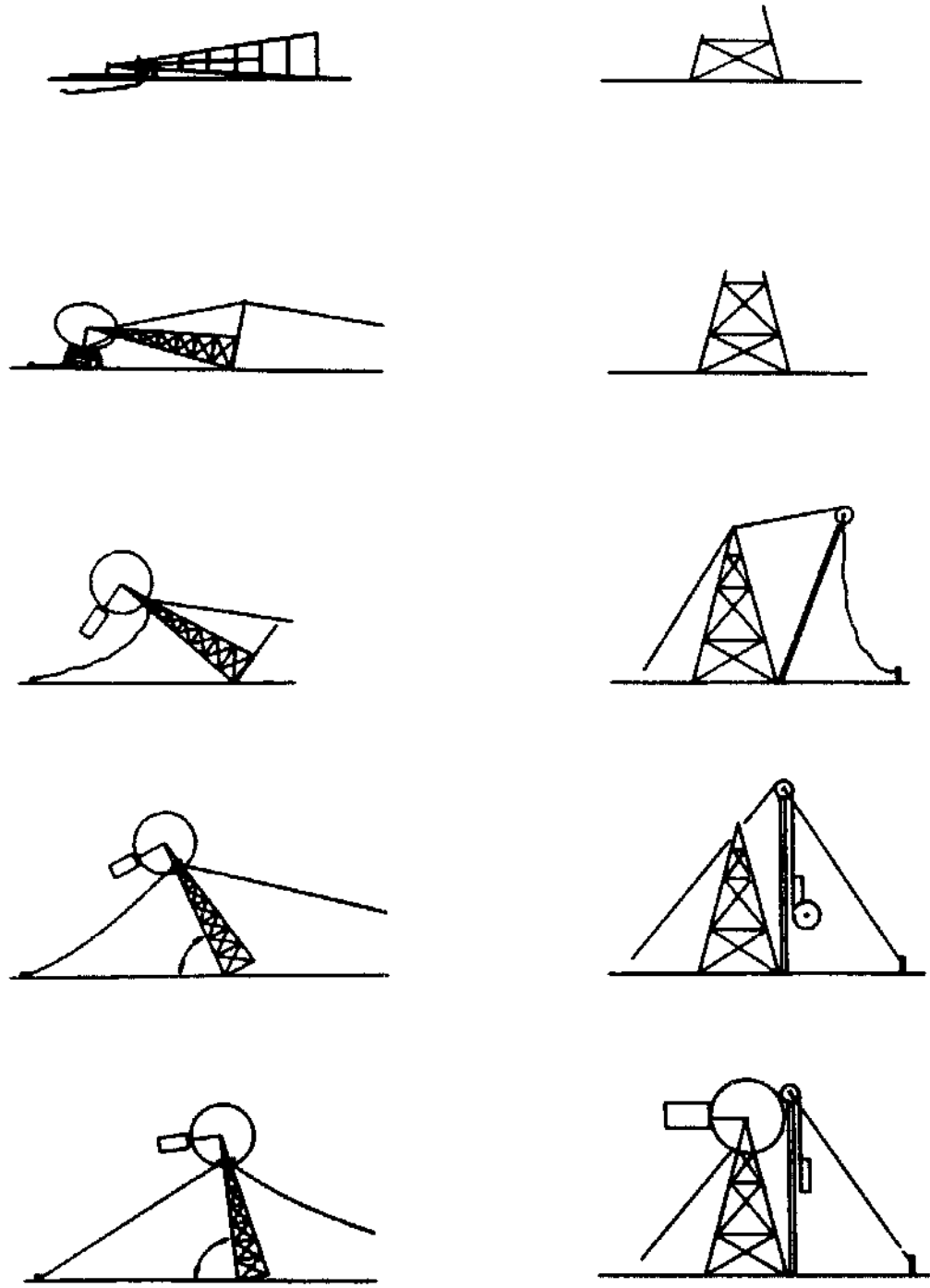

6.2.a Assembly on the ground and tilting (reference 16)

6.2.b Assembly from ground level upwards

Figure 6.2. Typical methods for erection of wind pumps.

## **Erection**

The installation of a windmill is a rather specialized job. The procedure might differ per type of windmill, and sometimes it can be necessary to adapt the erection procedure to specific conditions.

Two main types of installation procedures are encountered, illustrated in Figure 6.2.

- Assembly of the windmill while the tower is lying on the ground, and tilting the complete windmill to a vertical position.
- Assembly of the tower in its final position, working from ground level upwards, hoisting of the head, blades, vane and other parts by means of a gin pole.

Attention must be paid to corrosion protection. In a corrosive environment (salt and/or sand) all metal parts must be treated with one or two layers of anti-corrosive paint (e.g. red lead), and a layer of covering paint. After installation all damage to the paint should be restored. Even galvanized steel may need painting in a corrosive environment. It is good practice to grease all nuts and bolts.

During installation special attention must be paid to safety. Helmets should be used for protection against falling objects such as bolts and tools. Safety belts should be used by persons working in the tower. When hoisting heavy parts, or when tilting the machine, nobody should be allowed directly under it.

## **Installation of the pump**

Installation of a suction pump is rather simple. It is mounted directly on a central part of the concrete foundation. If no special syphon pump is used, it may be useful to apply a bend in the suction line going up and down as high as the pump in order to reduce the need for priming the pump (see Figure 2.6, Chapter 2).

Installation of a deepwell pump involves a considerable amount of work, depending, of course, on the depth. The tower of the wind pump itself is normally used as a hoisting rig. Pipes and pump rods (normally 6 m) are assembled and lowered together. On the pipe couplings some sealing material is applied (e.g. hemp). On the pump rod couplings, grease must be applied. Both pipes and pump rods must be tightened very well.

Connecting the pump rod to the windmill's transmission should be done very accurately in a way that the piston cannot hit the bottom or the top of the cylinder.

Depending on the layout of the installation, one must apply a pump rod sealing, air chambers, check valves.

A windmill must always have a free outflow. One may never put a valve directly in the delivery line, and care should be taken that no valve is applied anywhere in the distribution system which could completely shut off the windmill's outflow. Neglecting this precaution may result in serious damage to the pump and the windmill's transmission.

## 6.2.2. Operation and maintenance

### Operation

Methods of operating a windmill can differ widely for different types of windmills and for different applications. If a wind pump is owned by a centralized water supply authority, one person will normally be employed to be responsible for the wind pump and the distribution of water. On the other hand, when an individual farmer has a wind pump for irrigation, its operation is integrated in the work on the farm.

The tasks involved in operating a windmill are the following:

- Guard the wind pump against any damage by people or animals.
- Direct the windmill into the wind when water is needed.
- Furl the windmill when the storage tank is full.
- Man the taphouse at the hours of water distribution, or open the storage tank outlet when irrigation water is needed.
- Take readings of the water meter, for example twice a day, at fixed hours, if applicable.
- Certify any malfunction, and call assistance for repair.

### Simple maintenance

The operator (owner) of the windmill may perform several simple maintenance tasks. Of course, the tasks the operator will or will not fulfil depend on technical skills, availability of tools, and availability of outside assistance. The maintenance required depends on the type of wind pump and the circumstances in which it operates.

Simple maintenance generally includes the following:

- Greasing or oiling moving parts, for example once a month.
- Tightening the pump rod sealing. In case of large delivery heads, stuffing boxes require frequent tightening every week or every month. Counter pistons are less sensitive to maintenance.
- Cleaning. In some cases frequent cleaning of the wind pump's structure may be quite effective in corrosion protection.

### Advanced maintenance and repairs

Assistance of qualified mechanics is needed for more advanced maintenance, and for repairs. The organization of the maintenance may be realized by maintenance teams visiting wind pumps monthly on a routine basis.

Generally the following tasks can be distinguished:

- Changing the gear box oil, typically once a year.
- Inspection of bolts, and tightening if necessary, typically once a year (more frequently just after installation).



- Repair of broken pump rods. Most windmills have a breaking pin in the transmission, i.e. a part which can easily be replaced, and which has on purpose been designed to be the weakest point. Sometimes a complete length of pump rod needs to be replaced.
- Replacement of cup leathers. Typically, cup leathers last half a year to two years, depending on the quality of the water (e.g. whether it contains sand). If a large number of wind pumps at considerable distances equipped with deepwell pumps must be maintained, one should consider preventive maintenance by changing cup leathers at a fixed frequency (e.g. once a year, when changing oil).
- Corrosion protection. In corrosive environments it may be necessary to clean and paint a wind pump every year.
- Overhaul. After some 10 or 20 years of operation for imported classical wind pumps and 5 or 10 years for a locally manufactured wind pump, an overhaul of the machine may be needed, implying dismounting the rotor and the head, and replacing bearings and other worn-out parts.

### 6.3. Monitoring and evaluation (reference 17)

When carrying out a project aiming at the dissemination of a technology characterized by small installations in large numbers, it is essential to make due allowance for monitoring and evaluation of the project. Information is collected on the progress of the activity, the reliability of the technology, and its suitability in the specific situation. Also the assumptions made when starting the activity should be verified.

Information obtained by monitoring during the course of execution of a project may be used for adjusting the method of working or even the goals of the project. Information obtained from an evaluation after completion of a phase of the project or after the end of a project may be useful in defining a follow-up phase or may lead to conclusions which are of interest for other new projects.

Monitoring and evaluation efforts are especially important if a new technology is applied (innovative types of wind pumps, start of local manufacture), but also if the use of an established technology is expanded into new applications.

#### 6.3.1. Aspects of monitoring and evaluation

When defining the contents of monitoring and evaluation activities, it is important to keep in mind whom the information is intended for, whether the:

- Owner/operator, e.g. a small private farmer, a large water supply authority
- Promotor/implementor, e.g. an agricultural extension agency, a foreign donor agency
- Designer/scientist

A monitoring program or evaluation study will mainly include the following aspects:

### **Output performance**

Obviously, the amount of water pumped and the time at which it becomes available is of prime importance. The most important quantities involved are pumping rate, pumping height, and wind speed. For more background information, see Chapters 2 and 3. As a reference when performing output measurements, one may use the simple rule of thumb presented in Chapter 1. For a more detailed evaluation one may wish to refer to the output model presented in Appendix B, and illustrated in Figures B.1 and B.2.

### **Wind pump reliability**

Another very important issue for the user is the reliability of the technology. Due attention must be paid to the quality of the machines, not only under ideal testing circumstances but also in practical operating conditions.

### **Wind pump applications**

Besides inherent engineering aspects of a technology, it is essential to check its suitability for the application. The main applications of wind pumps are the following:

- Irrigation
- Human water supply
- Cattle watering
- Drainage
- Special applications: fish farms, salt ponds.

### **Costs**

Normally cost estimates are made before introducing a technology. However, in the case of wind pumps, available estimates on the costs of operation, maintenance and repair of the pumps are not necessarily reliable or applicable in specific situations (Chapter 5). It is good practice to keep a careful record of all costs incurred by all parties involved in operation, maintenance and repair of the pump. This information can be used to calculate the real cost of the pump in that actual situation.

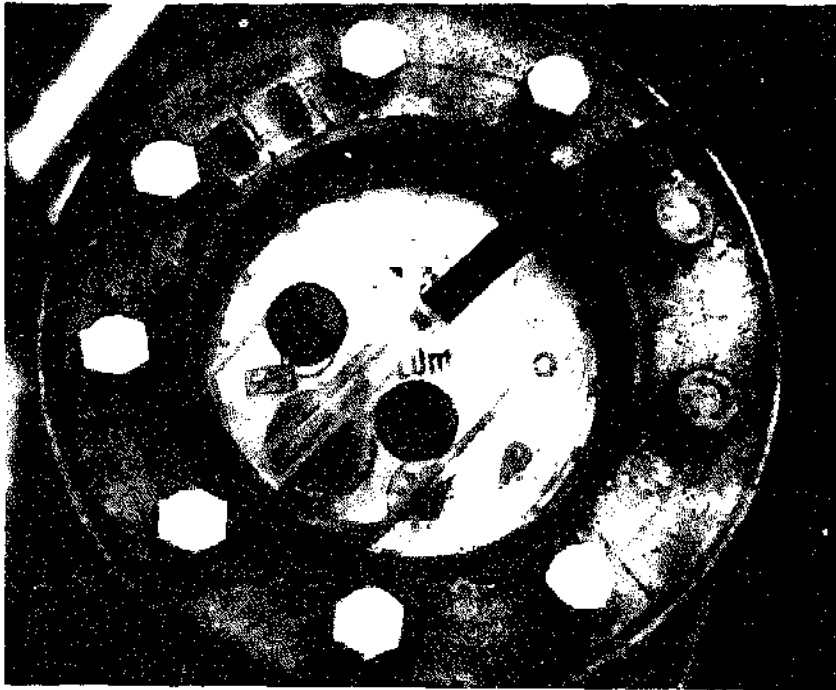

*Modified water flow meter for output monitoring at a testfield. A small magnet is attached to one of the dials to trigger a reed switch and generate pulses (CWD, Eindhoven, The Netherlands).*

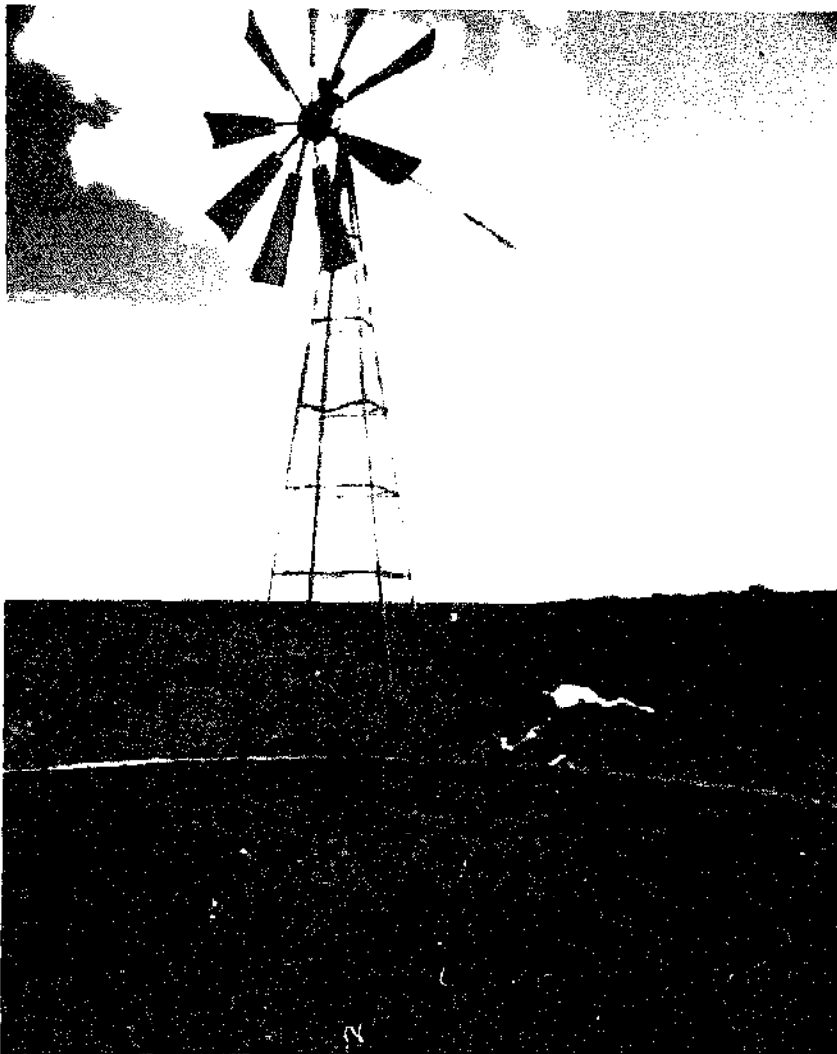

*Monitoring in actual use. Storage tank as 'interface' between windmill and user (Cattle ranch of Mr. Alberto Soares, owner of Mapel wind pump factory, Salvador, Brazil).*

## 6.3.2. Monitoring and testing

Basically two approaches are followed for monitoring and testing:

- Evaluation and testing of engineering aspects
- Monitoring of wind pumps in actual use

**Evaluation and testing of engineering aspects** of a certain type of wind pump must be done prior to any monitoring of actual use. The results concerning these purely technical aspects will serve as a reference during later monitoring programs in situations of practical application.

The following two types of tests are to be distinguished:

- o **Assessment of mechanical and operational quality by an expert.**  
Analysis of a wind pump's components with special attention for the safety system and ease and safety of operation. Calculation of stresses in critical parts. Suitability of construction principles and materials.
- o **Measurement of output wind speed curve.**  
It is common practice to present the output of wind machines as power curves, i.e. the output power as a function of wind speed. This kind of characteristic may be used for prediction of total energy output, when the wind speed frequency distribution is known. International standards have been proposed by the International Energy Agency for measurement of power curves (reference 32). Unfortunately, it was found recently that no unambiguous power curve exists for water pumping windmills. Therefore new procedures are being developed, but are not yet established (see Appendix B).

The evaluation and testing of engineering aspects of wind pumps can be done most easily and effectively at a special test site.

### **Monitoring of wind pumps in actual use**

By monitoring wind pumps in actual use one may obtain realistic information, directly applicable to practice.

With respect to output performance, information on cumulative output must be collected. If a storage tank is included in the system, this can be done in a very simple way by regularly reading the water level in the tank. More precise information may be obtained from measurements (Section 6.3.3) on a few selected wind pumps. With respect to mechanical and operational quality one must gather practical experiences concerning installation, operation, maintenance, breakdowns, after-sales service. The information may be obtained from installation and maintenance crews, owners, and operators.

Studies on user-related aspects may be oriented in various ways:

- o **Storage tank as "interface" between windmill and user.**  
Information is collected on lack and excess of water.

WIND PUMP PERFORMANCE							
Location .....							
Month .....							
System type .....							
.....							
Day	Time	Wind run counter reading	Flow meter reading	Static head	Average wind speed m/s	Volume pumped m <sup>3</sup> /day	Initials of recorder
1							
2							
3							
4							
5							
6							
7							
8							
9							
10							
11							
12							
13							
14							
15							
16							
17							
18							
19							
20							
21							
22							
23							
24							
25							
26							
27							
28							
29							
30							
31							

Table 6.1. Format sheet for recording wind pump performance.

Note: According to the circumstances and the information required, the frequency of reading indicated by the first column may be adapted: every ten minutes, daily, weekly, monthly.

- o **Influence of the windmill on the application.**  
Does the use of windmills require changes of irrigation practices?
- o **Detailed social and socioeconomic studies.**

Concerning cost aspects, collection of data on manufacturer's and supplier's prices is rather straightforward. Also costs of transport, taxes and installation should be evaluated to find the true cost of investment. During the use of a windmill, information must be collected on the costs of operation, maintenance, and repairs. Finally it is of great interest to obtain information on the (expected) life time.

Note that in a more detailed study one would make a complete economic analysis of both costs and benefits (Chapter 5).

### **6.3.3 Simple cumulative measurements**

The description presented is treated in detail in the Annex to this handbook. The simplest method of measurement is to take daily readings of:

- Average wind speed (wind run) at hub height
- Volume of water pumped
- Static head

This will enable the hydraulic power and hence output quality factor (Chapter 2) to be obtained for different values of the wind speed. A format sheet for recording such measurements is shown in Table 6.1.

Instrumentation selected for performance monitoring should meet the following requirements:

- Suitable for field use
- Allow on-site assessment of performance
- Have suitable accuracy (better than 5%)
- Require no power or power from a battery with a long battery life before discharge, (say greater than 1 month)

Three types of instrument are required in order to complete the daily recordings outlined above:

- a. A **wind run counter**, to determine the average wind speed. This can be either an electronic or a mechanical counter. Care must be taken to install the anemometer at hub height at a place where it is not shaded from the prevailing wind direction by any obstacle (including the wind pump itself).
- b. A **flow counter** to record total flow. The head loss caused by the flow meter should be kept to a minimum and the device should be capable of measuring flows in the range expected from the pump. The flow meter should integrate the flow, so that the volume of water pumped in a day can be obtained.

- c. A well dipper with a water-sensitive transducer that permits measurements of water level to be obtained easily. If the water source is a tubewell, sufficient access may need to be made at the well head for measurements of water level. The well dipping is usually performed manually and a reading is recorded daily.

## **6.4. Manpower and training requirements for installation of large numbers of wind pumps**

In large dissemination projects aiming at the introduction of hundreds of wind pumps, it is essential to set up an appropriate institutional framework. All personnel involved in the project must be adequately trained.

This section describes the tasks and functions involved in wind pump installation and in operation and maintenance. A variety of manpower will be needed, from unskilled workers through engineers to managers. Most of the skills required are general skills. Aspects for which specific knowledge on wind pumps is needed are indicated.

A more extensive discussion of the manpower needs for wind pump installations may be found in an ILO publication on the subject (reference 16).

### **Installation**

The following tasks can be distinguished in the installation of a wind pump:

- Site survey
- Procurement of wind pumps and components; transport to the site and other necessary logistics
- Construction of foundation (and storage tank)
- Erection of the wind pump and components
- Finalizing of the system: connection to distribution, test-run and initial painting (or other corrosion-protection).

In order to fulfil these tasks, the following key functions are required:

- Site surveyor
- Foundation worker
- Storage tank constructor
- Wind pump erector
- Plumber
- Test runner

Besides these key functions some other groups of functions are required:

- Technical support functions: wind data elaborator, procurement officer, store keeper, draughtsman, designer civil work
- Management functions
- Administrative and managerial support functions

Note that these are lists of functions. Of course, several functions might be combined in one person. The functions of site surveyor, wind pump erector, test runner and technical manager are specific to the installation of wind pumps.

The site surveyor selects and evaluates the installation sites; he gathers all necessary information, makes a layout of the installation, selects the components of the future installation and presents a time schedule and a budget. Site survey requires a broad view, since many disciplines are involved: meteorology, (geo)hydrology, topography, logistics, civil engineering.

The wind pump erector builds the wind pump and installs its components according to the installation manual using both skilled and unskilled personnel.

The test runner checks a newly installed wind pump system and carries out a test run.

Preferably all personnel involved should be given an introductory course in wind energy. Specific training is needed for the site surveyors and their supervisors, requiring a course of approximately 6 to 9 months at polytechnic level (engineer school).

Specific training is also needed for the technical installations manager. His education can be as a civil engineer. Additional training should be given in the fields of general wind energy, forces and moments acting on a wind pump and its components, pump design, and storage tank construction. The duration of such a program would be approximately 6 months.

The installation personnel (erectors and test-runners) need special training to be given either in-house, or by the wind pump manufacturer. Depending on the complexity of the wind pump, this training can take as little as 2 weeks or as much as 6 months. The contents of the training depend entirely on the type of machine purchased and the installation procedure.

## **Operation and maintenance**

The following tasks can be distinguished in the operation of wind pumps:

- To administer the (group of) wind pump installation(s) for which the "operation company" is responsible.
- To have an operator (operators) at each wind pump capable of doing their job.
- To carry out maintenance with the frequency and quality required for successful operation.
- To carry out repairs immediately when necessary and effectively, in order to keep breakdown time below a prescribed value.
- To have spare parts available in sufficient numbers.
- To have equipment and tools available and in good condition in order to carry out maintenance, service and repairs.
- To register the useful quantity of water produced by the wind pump system, and collect the revenue from the users.



In order to fulfil these tasks the following key functions are required:

- Wind pump system operator
- Maintenance and repair mechanic
- Painter

Again, some other functions are required besides the key functions:

- Technical support functions: quality supervisor, procurement officer, spare parts storekeeper, equipment maintenance personnel, instrument maintenance person.
- Management functions.
- Administrative and managerial support functions.

The functions of wind pump system operator, maintenance and repair mechanic, quality supervisor and technical manager are specific to the operation and maintenance of wind pumps.

The operator is responsible for all manual operation maneuvers and for checking the correct operation of the wind pump. This includes starting and stopping, opening and closing of valves. He takes regular readings, e.g. of water counters. He reports any malfunctions. In case of rural water supply he will be responsible for water distribution and revenue collection.

The maintenance and repair mechanic carries out maintenance according to a prescribed routine and frequency; he carries out repairs when needed.

The quality supervisor is responsible for the quality of the wind pump systems under his care as well as of the output measurements and the logbook keeping. He instructs and supervises the wind pump operators, checks the work of maintenance and repair teams. The quality supervisor is also responsible for any measurements.

Specific training on wind pumps (additional training) is needed for wind pump operators, maintenance and repair personnel, the quality supervisor and the technical manager.

The training course for operators can consist of a few weeks instruction course, in which practical work is interspersed with some lectures. The main course material concerns the wind pump of the type for which the operators are trained. Wind pumps have various applications, and operation strategies may differ per application. The contents of a particular course depend on the kind of application in the area. Practical exercise should have the greatest emphasis, and so the trainees should operate the wind pump under the guidance of the instructor.

Mechanics with adequate education still have to be trained before they can participate in a maintenance and repair team. Basic course material should consist of the service and maintenance manual. Again, practical training is the most important aspect.

The training of the quality supervisor and technical manager runs along the same lines as indicated earlier for the technical installations manager.



*Local manufacture in Kenya.*



*Local manufacture in Mozambique.*

## Appendix A WIND RESOURCES



*Nature has its indications of prevailing wind speeds; a tree exposed to the trade winds on one of the islands of Cape Verde.*

## Appendix A

### WIND RESOURCES

The accurate determination of available wind resources is a rather difficult and uncertain task, especially in comparison with solar energy. The reasons are the following:

- A large variety of wind speeds is found for different regions of the world, from an average of 2 m/s, through 4 m/s to 7 m/s at very windy places. This variety of wind speeds implies an even larger variety of power availability, from 5 through 40 to 200 W/m<sup>2</sup>. This variability is huge in comparison with solar power resources (ranging from 10 to 25 MJ/m<sup>2</sup>/day throughout the tropics).
- Large differences in wind speed (and hence power) are observed over small distances due to varying terrain topography and roughness. Within a few kilometers the wind power may vary by one order of magnitude.
- It is difficult to measure wind power accurately. Wind is normally measured as wind speed. The power in the wind is proportional to the cube of the wind speed, meaning that a small error in wind speed causes a much larger error in the calculated power. For example, the power in a 5 m/s wind is twice that of a 4 m/s wind ( $5^3/4^3 = 125/64 \approx 2$ ). An error of 10% in wind speed means an error of 33% in average power. On the contrary, solar energy is normally measured as hours of sunshine or irradiation, both approximately proportional to the available solar energy.

For these reasons it is not possible to present a simple straightforward procedure for the assessment of wind energy resources. This appendix will give an introduction to the main aspects and terminology involved.

The first section of the appendix describes general phenomena of wind flow. The second section deals more specifically with wind resource assessments, paying attention to desirable data format and site evaluation. The final section presents some useful conversions, graphs, and units.

#### A.1. Wind on a worldwide scale

An excellent text book on wind energy resources is the Technical Note 175 by WMO, the World Meteorological Organization, which was used as a source for this section (reference 7).

Ultimately, the origin of wind energy is solar energy. Temperature differences caused by solar radiation give rise to a variety of circulation patterns in the earth's atmosphere, which are strongly influenced by the rotation of the earth.

The total solar power flow absorbed by the earth is of the order of  $10^{17}$  W, which is roughly 10,000 times the total human energy consumption rate. A small portion of this solar power flow (approximately 1%, or about  $10^{15}$  W, or 100 times the total human energy consumption rate) is converted into atmospheric motion or wind (reference 26).

On a global scale the regions around the equator receive a net gain of energy while in the polar region there is a net loss of energy by radiation. This implies a mechanism (in reality very complex) by which the energy received in the equatorial regions is transported to the poles.

The air masses heated in the equatorial regions rise (causing the formation of clouds and thunderstorms) in a relatively narrow band of about 100 km wide called the Inter Tropical Convergence Zone, ITCZ, lying more or less parallel to the equator around the earth (with an interruption in Asia, where a monsoon circulation prevails. See below). In the upper atmosphere these air masses split, one part moving away from the equator southwards, the other northwards. Near the equator these masses have roughly the same speed (west to east) as the surface of the earth, owing to its rotation. However, moving away from the equator the speed of the earth's surface decreases and as a result the air masses develop an excess speed (relative to the earth) in an eastward direction. Therefore, the motion of air away from the equator is not purely north and south, but has a component in an easterly direction.

Moving away from the equator, the air cools and becomes heavier. At approximately  $30^{\circ}$  N and S it starts sinking, causing a dry and cloudless climate. At these latitudes one finds large deserts all around the world.

The air moves towards the equator again as trade winds. Due to the rotation of the earth the wind direction deviates clockwise on the northern hemisphere, and anticlockwise on the southern hemisphere. Therefore, the direction of the trade winds is not N and S, but rather NE and SE.

This circulation pattern, called the Hadley circulation, is tied to that of the ITCZ which moves north of the equator during the summer (in the northern hemisphere) and south in the winter. It is very stable and hence the trade winds are very persistent. In the ITCZ itself the winds are light, interrupted by thunderstorms. This region is referred to as "the doldrums" because of the long periods of calm experience there.

At subtropical latitudes one finds a jet stream from west to east in the upper layers of the atmosphere, which is caused by the excess speed of air masses moving away from the equator, as indicated above.

Outside the Hadley circulation westerly winds are predominant. This circulation is rather unstable and is characterized by wave-like structures and the formation of depressions generally moving from west to east.

Figure A.1, taken from reference 7, gives a schematic picture of this general circulation on a global scale.

Deviations from the general symmetrical pattern of air movement occur due to the uneven distribution of land over the globe. On the average, more land is concentrated in the northern than in the southern hemisphere. Since land is heated more easily by the sun than the oceans, the average position of the ITCZ is about  $5^{\circ}$  North of the equator.

In Asia one finds the Asian Continent to the north and the Indian Ocean to the south. The continent is heated strongly during the summer, giving rise to the moist and hot SW monsoon, basically an extension on the northern hemisphere of the SE trade winds of the southern hemisphere. In the winter the continent cools and one finds the NE monsoon, which is related to the NE trade wind.

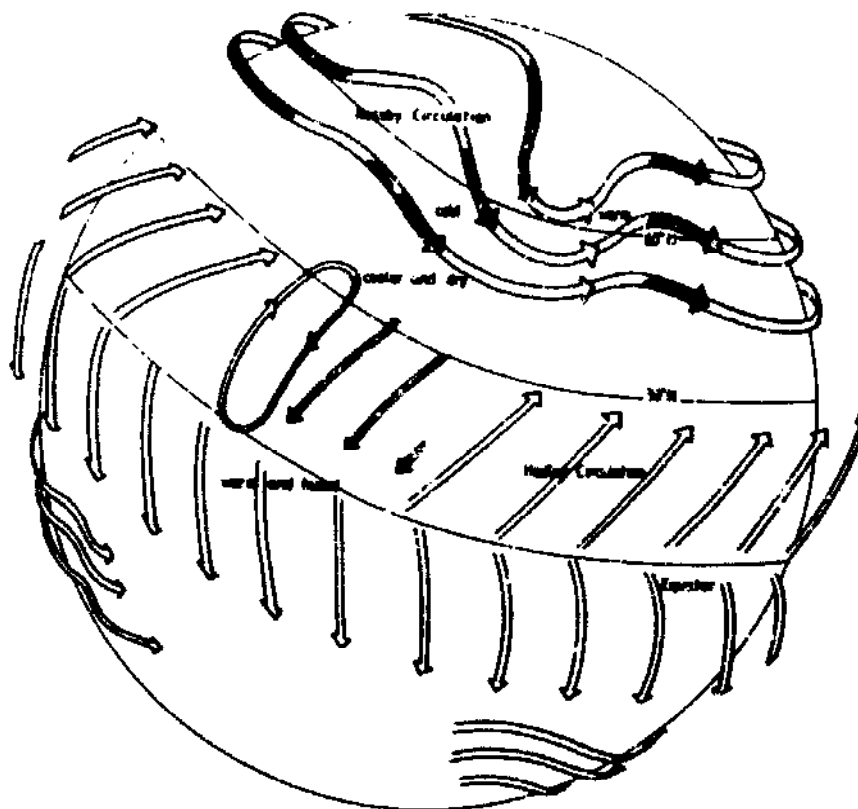

Figure A.1. Schematic picture of the general circulation of air around the globe. North and South of  $30^{\circ}$  N and  $30^{\circ}$  S, respectively, a westerly circulation prevails, while in the tropics one finds NE and SE trade winds (reference 7).

Cyclones and depressions are important disturbances of the general circulation pattern. In specific tropical regions one finds devastating tropical cyclones (called typhoons in SE Asia, and hurricanes in the Caribbean). In such tropical cyclones wind speeds of over 60 m/s are observed frequently. Depressions in other tropical regions and in moderate climates give rise to storms which are less severe, with wind speeds rarely exceeding 40 m/s.

### **Macro-scale wind (100 - 10,000 km)**

The wind flow originating from the global circulation is often referred to as macro-scale wind. The horizontal scale involved runs from a hundred to several thousands of kilometers. The macro-scale wind (undisturbed by the detailed surface features of the earth except for mountain ranges) is found at altitudes above 1000 m.

Apart from the macro-scale wind it is usual to distinguish two more scales: meso-scale and micro-scale.

### **Meso-scale wind (5 to 200 km)**

Variations of the features of the earth's surface with a horizontal scale from 10 to 100 km have an influence on the wind flow between 100 and 1,000 m height above terrain. Obviously, topography is important, e.g. the wind tends to flow over and around mountains and hills. Any large-scale roughness of the earth's surface decelerates the air flow.

Close to shores one may observe land-sea breeze patterns. During the day the land is heated more than the water (sea or lake), the air over the land rises, and a sea breeze develops. During the night the land is cooled to temperatures below those of the water, causing a land breeze. This is usually weaker than the sea breeze.

Another example concerns mountain-valley winds. During the daytime, the slopes of mountains are heated, the air rises and the wind tends to blow through the valleys up along the mountain slopes. During the night the reverse happens: cold air moves down from the mountain slopes, forcing the wind to blow down through the valleys. Figures A.2 and A.3 give a schematic illustration of these two examples.

In tropical regions thermal winds are very common. These winds, which are caused by temperature gradients along the surface of the earth, can be quite strong in day-time, especially in desert like regions.

### **Micro-scale wind (up to 10 km)**

On the micro-scale surface winds (below 60 to 100 m above terrain), which are of course the most interesting for direct application for wind energy conversion, are influenced by local surface conditions, such as terrain roughness (vegetation, buildings) and obstacles.

For flat terrain some very helpful general concepts have been developed.

The wind profile, i.e. the wind speed as a function of the height above the surface, can be expressed in a very simple relationship. The shape of this profile depends mainly on the roughness of the terrain. The greater the roughness (related to the average height of obstacles), the more the wind is decelerated close to the surface. General classification methods have been developed to quantify this roughness (see Table A.4). The roughness, as observed from a specific site, may be different in different directions; hence the wind profile will also depend on wind direction.

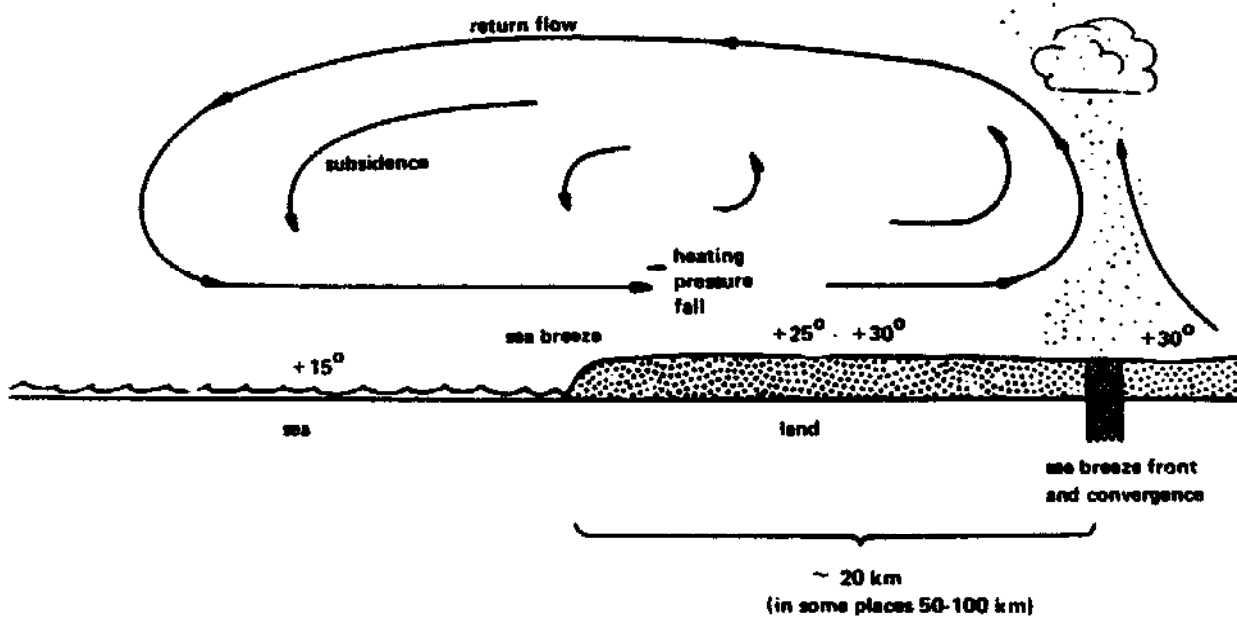

Figure A.2. Simple schematic picture of sea-breeze circulation (reference 7).

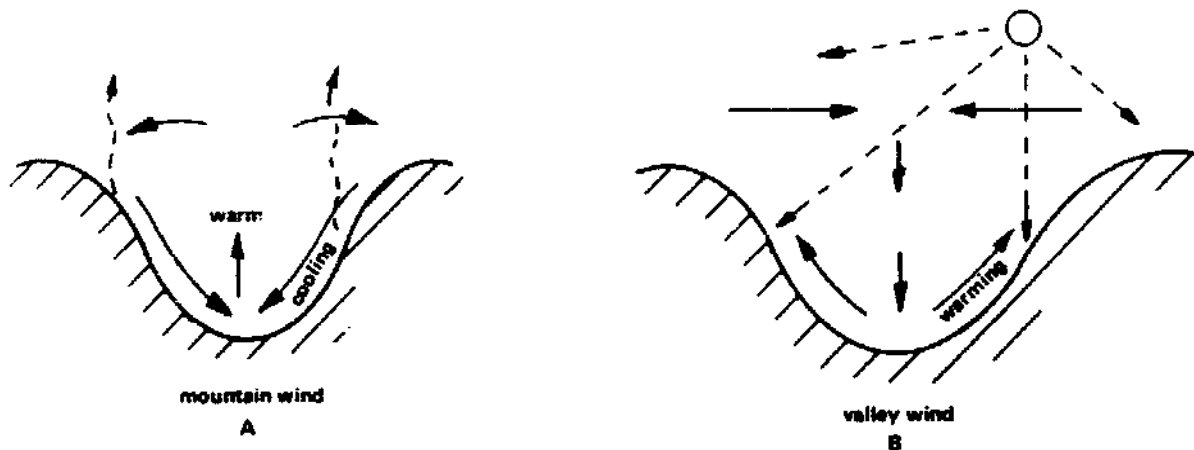

Figure A.3. Schematic illustration of mountain (A) and valley (B) wind (reference 7).

Another important concept is the **potential wind speed**, i.e. the wind speed which would be observed in completely flat and open terrain, usually specified for 10 m height above terrain. The potential wind speed is basically a meso-scale quantity. Because of its definition it does not depend on local (micro scale) roughness characteristics. Through the profile for flat and open terrain it is related directly with the wind speed at 60 to 100 m height above terrain. It is a suitable quantity to be indicated in wind maps. Being a meso-scale quantity it is fairly constant over reasonable distances (a few kilometers). In order to find the actual wind speed at a specific site one must apply corrections to the potential wind speed, which depend on the site's roughness characteristics. For detailed formulas and graphs, see Section A.3.



In so-called "complex" terrain (mountains, hills, valleys) the situation is quite different. Flow of wind over and around mountains is very complex, and so far no simple analytical concepts (like wind profile, roughness, and potential wind speed) exist for modeling such flows.

### Global map of wind resources

The WMO, World Meteorological Organization, has put considerable effort into wind energy meteorology by developing a global map of wind resources, which is included in the technical note mentioned earlier (reference 7). The result is shown in Figure 1.4. on page 8.

As indicated by the WMO, this map must be used with great care, since locally very large differences may be found. It cannot be used to predict in a straightforward way the wind regime at any spot on the globe. However, it does provide useful and comprehensive information needed for making preliminary assessments of wind resources.



*Typical example of an anemometer location that is inappropriate for data collection for wind energy applications. The anemometer is shielded off by buildings and its height above the ground is insufficient.*

## A.2. Wind data requirements

This section provides additional information relevant to the utilization of wind energy for water pumping. It starts with an overview of the data ideally required for sizing and evaluating wind pump installations, then gives a brief overview of methods for collecting the data in a generalized way on a regional or national level. Finally, site selection and site evaluation are treated.

### Data requirements

The following classes of information are of interest in relation to the application of water pumping windmills. (For more details, see references 3 and 8).

- o **Average wind speed:** The long-term average wind speed may be used as a first, general indication of the feasibility of the application of wind energy.
- o **Seasonal variations:** Data on seasonal variations of wind speed (normally presented as monthly averages) are of importance to estimate the seasonal variations of windmill output, and to determine the "critical" or "design" month for which a wind pump installation must be designed.
- o **Diurnal variations:** Diurnal variations (variations during the course of the day) may have a great influence on the feasibility of wind energy application. For example, in a region having a constantly low wind speed of 2 m/s 24 hours each day, feasibility would be doubtful. However, in a region having no wind 16 hours per day, and a wind of 6 m/s over 8 hours per day, water pumping windmills could be cost-effective. Yet in both cases the average daily wind speed is identical at 2 m/s.
- o **Storms, gusts:** Data on storms and maximum gusts are used to define the maximum wind speeds that wind machines must be able to withstand. For moderate climates and for tropical climates without typhoons, 40 m/s is often assumed to be a safe value, and in a few cases 50 m/s is considered safe. In typhoons wind speeds may exceed 70 m/s.
- o **Calms:** Information on long periods of low wind speeds is needed to calculate the dimensions of storage tanks to store water at times when the wind pump is not operating.
- o **Wind speed frequency distribution:** For an accurate estimate of the probable energy production of any wind machine, the frequency distribution of wind speed ("percentage of time that each wind speed occurs") is needed.

Figure A.4 contains some illustrations of this information, all referring to the speed of the wind. As indicated in Chapter 1, the power contained in the wind is proportional to  $\frac{1}{2}\rho V^3$ . By far the most important factor involved is the wind speed  $V$ . However, one may not neglect the influence of  $\rho$ :

- **Air density:** The density of the air varies with temperature and barometric pressure. Especially at high altitudes a considerable reduction of  $\rho$  may be found. (Table A.3).

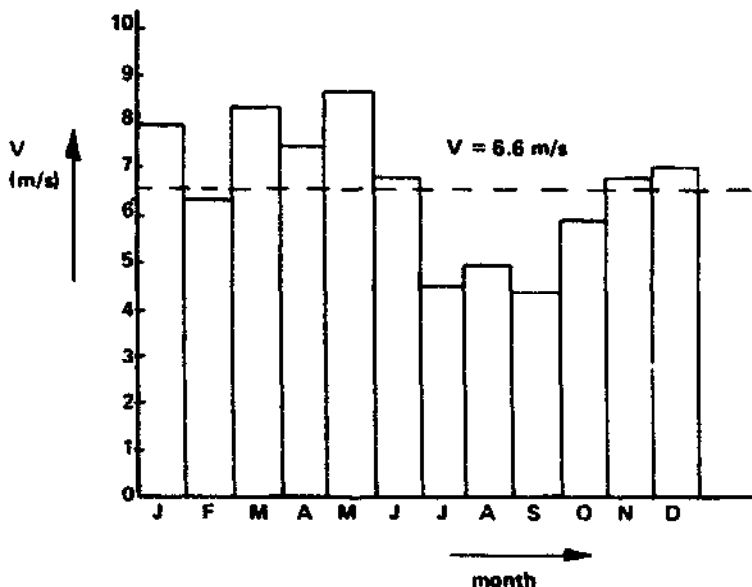

a. The monthly average wind speed at Praia airport, Cape Verde, in the year 1978.

hours	V < 2m/s	< 3m/s	< 4m/s	< 5m/s	< 6m/s
1	/	III	III III II	III II	III III I
2	/	II	III III	III I	III II
3	/		III	III	III
4		/	III	III	III I
5		/	III I	III I	I
6					III
7			/	/	
8			II	II	II
9			/	/	/
10			/	/	III
11					
12					III
13					
14					
15					
16					
17					/
18					
19					
20					
21					
22					/
23					
24					

c. Distribution of the number of periods that the wind speed was smaller than a given value during a consecutive number of hours (data from Praia airport, Cape Verde, June 1975).

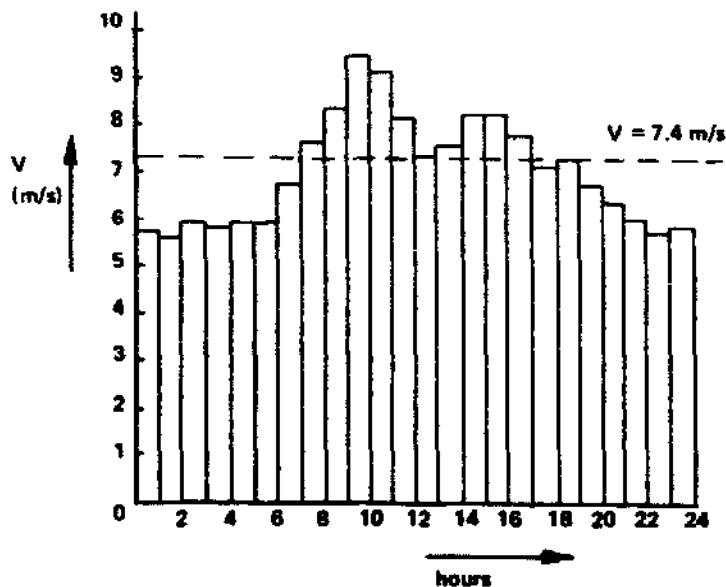

b. Diurnal pattern of the wind speed at Praia airport, Cape Verde in the month of June 1975

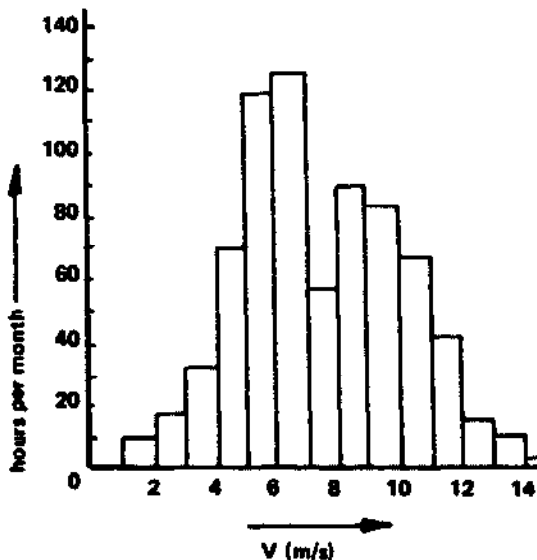

d. The velocity frequency data for Praia airport, Cape Verde (June 1975), in a histogram

Figure A.4. Information relevant to the utilization of wind energy for water pumping (reference 3).

## **Wind resource assessments**

A brief description of possibilities for wind resource assessments has been given in a paper prepared under the GWEP (Global Wind Pump Evaluation Programme) for which this handbook was written (reference 8).

The first approach to wind assessment should be to use existing information. In most countries data may be obtained from the climatological department of the national meteorological service. Airports are also a useful source of data. They collect data which are often quite useful since airport wind is normally measured at 10 m height above flat, open terrain.

It is not generally advisable to take data from agro-meteorological services. Much of their wind data are normally of little interest for wind energy applications since measurements are performed at 2 m height or lower at sites that are not always well exposed to the wind.

While available data on a region or country is useful for a first impression of wind resources, one should be careful not to draw detailed conclusions from these data. In practically all detailed surveys of wind regimes carried out in industrialized and developing countries, reliability and accuracy of data have proved to be limited or even poor. Errors occur related to the exposure of the anemometer (buildings, growing trees), calibration and functioning of the anemometer, and to data collection.

For more reliable information a wind energy expert (if he is available) should be asked to perform a detailed survey. The work would include:

- o Desk study of type of climate, seasonal variations to be expected, overall movements of air masses, contour maps.
- o Field trips to study landscape features relevant for wind flow such as hills, plains, valleys, ridges, and biological indicators of wind speed such as bending trees; and to talk with local people.
- o Visits to meteorological stations, paying attention to the exposure of the anemometer to the wind, condition of the equipment, and methods of data collection used.
- o Collection of data from selected meteorological stations, either from the stations themselves or from some supervisory service.
- o Analysis and interpretation of data.

Sufficient information is usually obtained from the survey for a general feasibility study and to permit a decision on whether to initiate a pilot project.

It is also desirable to take new measurements to verify existing data, to investigate specific or representative sites, and to collect data in a more suitable format.

The contents of any measuring program will depend strongly on the situation and the purpose for which the information will be used. Some general features of such a program are:

- Classification of typical regions and landscapes according to the type of wind regime.
- Detailed (time sequential) measurements at a limited number of sites characteristic for the typical regions or landscapes.
- Simple cumulative measurements at a larger number of sites, representative for future wind pump installations.
- Comparison of data with data obtained from existing meteorological stations that have acquired records over a long period of time.

In order to obtain complete and accurate measurements, a period of several years would be required. Of course, this is not always feasible. However, it is important to obtain the most accurate information possible. This is why it is best to consult a wind energy expert.

### Site selection

An excellent text book on siting of small wind machines is the handbook by H.L.Wegley (reference 6).

When selecting a site for installation of a wind pump, one should obviously try and select a site that is as windy as possible. Of course, there must be an adequate source of water at the site. An existing well may be used, or a new one may be constructed.

The site should be free of large obstacles. "Behind" an obstacle, as seen from the main wind direction, the wind flow is disturbed in an area twice as high as the obstacle and extending horizontally 10 or 20 times the obstacle height. In this area the wind speed is lower and wind turbulence (rapid variations of wind speed and direction) is strong. The low wind speed causes reduced output, while wind turbulence puts stress on the windmill, shortening its lifetime. If possible, one should install any windmill in such a way that the rotor is completely clear from the region of disturbed flow, as indicated in Figure A.5.

The effect of surface roughness is important. A high roughness tends to decrease wind speed. One should try and install a wind pump in flat terrain that is open up to a distance of 1 or 2 km, especially in the main wind direction.

In complex terrain (valleys, mountains, etc.) one should consider the general flow of air over the terrain in order to find the windiest sites. For example the middle of a valley may be a good site. If some kind of remote transmission is applied, the top of a smooth hill can be a good site. (Figure A.6).

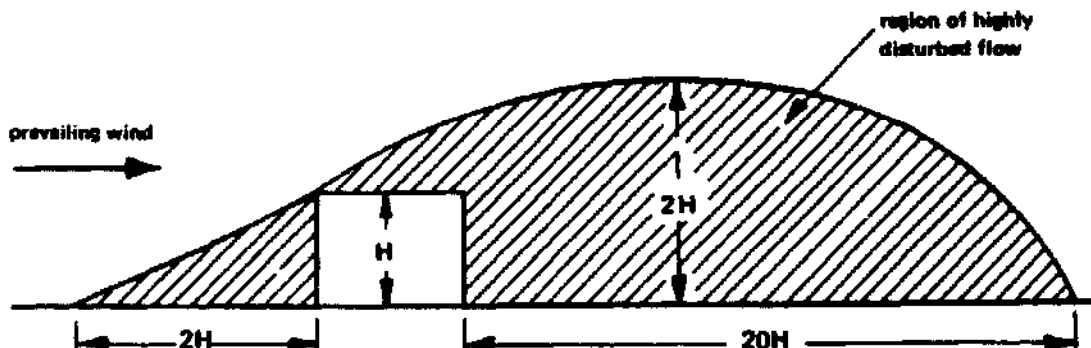

Figure A.5. Zone of disturbed flow over a small building (reference 6)

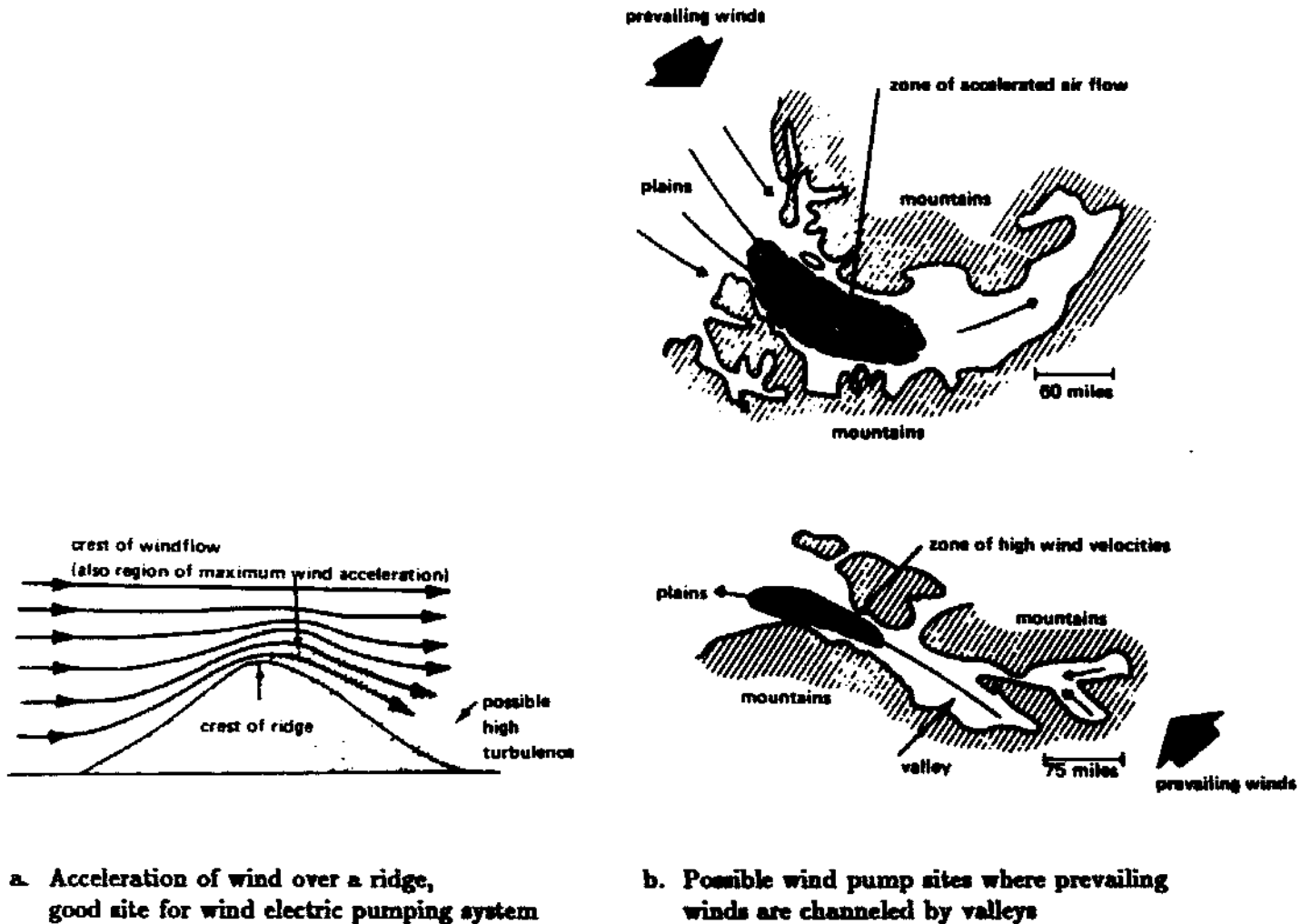

Figure A.6. Siting of wind pumping systems in complex terrain (reference 6).

### Site evaluation

Once a site has been selected, the wind potential of the site should be evaluated.

In flat terrain, ideally, a wind map would be available. By studying detailed maps and by visiting the site it should be possible to establish its roughness characteristics. The appropriate corrections can then be applied in order to find the site's wind characteristics. (Section A.3 gives details on the calculation).

Often no wind map will be available, and one will have to use data from nearby meteorological stations. In this case one should estimate the potential wind speed using the roughness characteristics of the meteorological station, and convert it to the site's wind speed using the roughness characteristics of the site. If large distances are involved, one will have to consider the problem on a meso scale. For example, at an inland site the wind speed is generally lower than at a meteorological station situated near the coast.

If the estimate obtained is considered to be insufficiently accurate, one may wish to perform on-site measurements for a short period, e.g. a few months. Comparing the data thus obtained with simultaneous data of a nearby meteorological station, one may try to find a correlation (which may be different for different wind directions!). If a consistent correlation is found, one may estimate the long-term wind characteristics at the site using long-term data from the meteorological station and the correlation derived from the short-term measurements.

In complex terrain, it is much more difficult to make any general estimates. One may use data from comparable sites, although it will be difficult to assess what a "comparable" site is. Short-term measurements may be useful, trying to establish a correlation with a nearby meteorological station, as indicated above. A problem may be that the wind direction is affected by the topography of the terrain.

### A.3. Wind in graphs and numbers

This section contains the following information needed for wind evaluation:

1. Conversion of units
2. The Beaufort scale
3. Density of air
4. Height and roughness corrections
5. The Weibull distribution.

#### A.3.1. Conversion of units

	m/s	km/hr	mph	knots
1 m/s	1.000	3.600	2.237	1.944
1 km/hr	0.278	1.000	0.622	0.540
1 mph	0.447	1.609	1.000	0.869
1 knot	0.514	1.852	1.151	1.000

Table A.1. Conversion of units of wind velocity.

**A.3.2. The Beaufort scale**

Beaufort number	knots	MPH	m/second	km/hour	seaman's term	World Meteorological Organization (1964)	estimating wind speed by effects observed on land
0	under 1	under 1	0.0-0.2	under 1	calm	calm	Calm; smoke rises vertically.
1	1-3	1-3	0.3-1.5	1-5	light air	light air	Smoke drift indicates wind direction, vanes do not move.
2	4-6	4-7	1.6-3.3	6-11	light breeze	light breeze	Wind felt on face; leaves rustle; vanes begin to move.
3	7-10	8-12	3.4-5.4	12-19	gentle breeze	gentle breeze	Leaves, small twigs in constant motion; light flags extended.
4	11-16	13-18	5.5-7.9	20-28	moderate breeze	moderate breeze	Dust, leaves and loose paper raised up; small branches move.
5	17-21	19-24	8.0-10.7	29-38	fresh breeze	fresh breeze	Small trees in leaf begin to sway.
6	22-27	25-31	10.8-13.8	39-49	strong breeze	strong breeze	Larger branches of trees in motion; whistling heard in wires.
7	28-33	32-38	13.9-17.1	50-61	moderate gale	near gale	Whole trees in motion; resistance felt in walking against wind.
8	34-40	39-46	17.2-20.7	62-74	fresh gale	gale	Twigs and small branches broken off trees; progress generally impeded.
9	41-47	47-54	20.8-24.4	75-88	strong gale	strong gale	Slight structural damage occurs; slate blown from roofs.
10	48-55	55-63	24.5-28.4	89-102	whole gale	storm	Seldom experienced on land; trees broken or uprooted; considerable structural damage occurs.
11	56-63	64-72	28.5-32.6	103-117	storm	violent storm	
12	64-71	73-82	32.7-36.9	118-133			Very rarely experienced on land; usually accompanied by widespread damage.
13	72-80	83-92	37.0-41.4	134-149			
14	81-89	93-102	41.5-46.1	150-166			
15	90-99	104-114	46.2-50.9	167-183	hurricane	hurricane	
16	100-108	115-125	51.0-56.0	184-201			
17	109-116	126-136	56.1-61.2	202-220			

Table A.2. Beaufort scale, used for classifying wind speeds (reference 36).



### A.3.3. Density of air (reference 3)

Height above sea level	Density of dry air at 20°C	Density of dry air at 0°C
0	1.204 kg/m <sup>3</sup>	1.292 kg/m <sup>3</sup>
500	1.134	1.217
1000	1.068	1.146
1500	1.005	1.078
2000	0.945	1.014
2500	0.887	0.952
3000	0.833	0.894
3500	0.781	0.839
4000	0.732	0.786
4500	0.686	0.736
5000	0.642	0.689

Table A.3. The density of dry air at different altitudes under standard conditions (reference 3).

### A.3.4. Height and roughness corrections

Wind speed profile at one location under neutral atmospheric conditions (reference 3). If the wind speed  $V(z_r)$  is known at some reference height  $z_r$ , the wind speed  $V(z)$  at any other height  $z$  up to 60 m at the same location can be estimated as follows:

$$\frac{V(z)}{V(z_r)} = \frac{\ln(z/z_0)}{\ln(z_r/z_0)}$$

- $z$  height (m)
- $z_r$  reference height (m)
- $z_0$  roughness length, see below (m)
- $\ln$  the natural logarithm

The roughness height is related to the type of terrain according to Table A.4.

flat	beach, ice, snow landscape, ocean	$s_0 = 0.005$ m
open	low grass, airports, empty crop land,	$s_0 = 0.03$ m
	high grass, low crops	$s_0 = 0.10$ m
rough	tall row crops, low woods	$s_0 = 0.25$ m
very rough	forests, orchards	$s_0 = 0.50$ m
closed	villages, suburbs	$s_0 > 1.0$ m
towns	town centers, open spaces in forests	$s_0 > 2$ m

Table A.4. Roughness classification (reference 3).

Conversion of wind speed at a reference location (e.g. meteorological station) into wind speed at a site (reference 3):

If the wind speed  $V(z_r)$  is known at a reference height  $z_r$  at one location with a roughness height  $z_{or}$ , then the wind speed  $V(z)$  at a height  $z$  at a nearby site with a roughness height  $z_o$  is calculated using:

$$\frac{V(z)}{V(z_r)} = \frac{\ln(60/z_{or}) \ln(z/z_o)}{\ln(60/z_o) \ln(z_r/z_{or})}$$

- $z$  height at site (m)
- $z_o$  roughness height of site (m)
- $z_r$  height of data of reference location (m)
- $z_{or}$  roughness height, reference location (m)
- $\ln$  the natural logarithm

This formula is graphically shown in Figure A.7. Note that the potential wind speed (at 10 m height) which is the same for both sites should be calculated as an intermediate step.

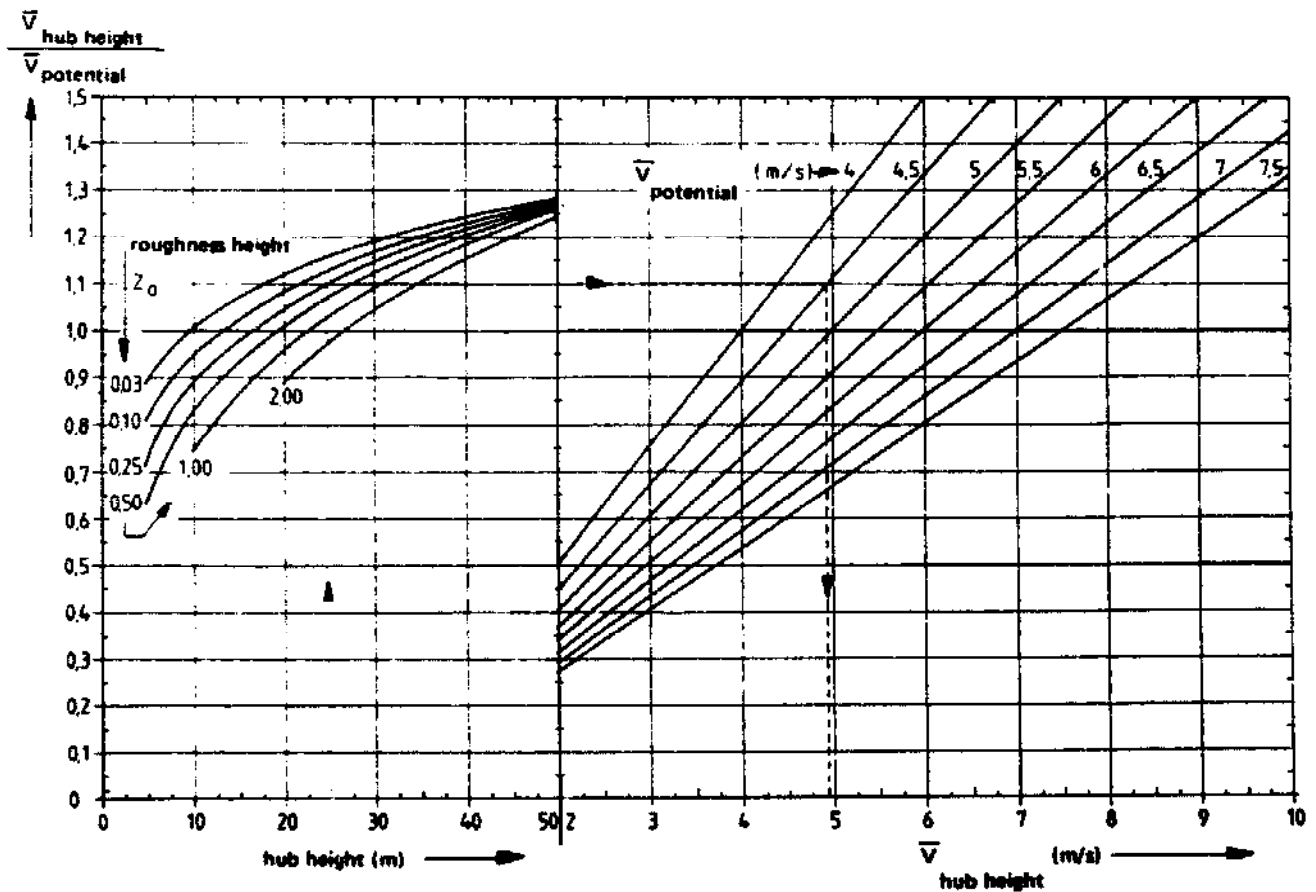

Figure A.7. Average wind speed at hub height of rotor (reference 28). See Table A.4. for values of roughness height.

### A.3.5. The Weibull distribution (reference 3)

Most of the frequency distributions of all wind regimes of the world can be approximated by using the Weibull distribution, which is calculated as follows:

$$F(V) = 1 - \exp \left[ - \left\{ \frac{V}{c} \right\}^k \right]$$

V wind speed

k shape factor

c parameter, related to average wind speed:

$$\frac{\bar{V}}{c} \approx 0.89$$

The Weibull distribution is shown in the graph below for various values of the shape factor k.

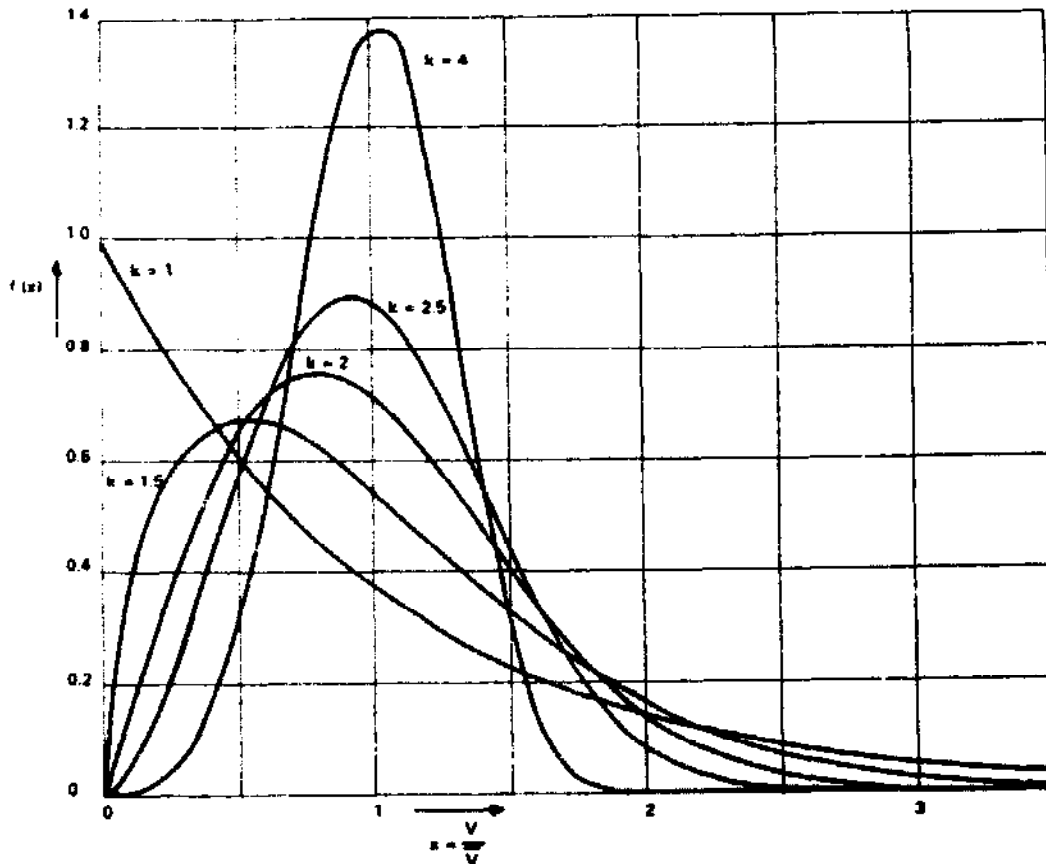

Figure A.8. The Weibull distribution.

A small value of k corresponds to a variable wind, a large value to a more constant wind; roughly the following k values are found for different climates:

- k = 1.5 strongly variable wind: polar regions, thermal winds (land/sea, mountain/valley), winds having a strong day/night variation.
- k = 2.0 moderately variable wind: moderate climates.
- k = 3.0 constant winds: trade winds, tropical regions.

The practical procedure to find the Weibull shape factor from a given set of data starts with establishing the cumulative distribution of the data. The cumulative distribution refers to the total number of hours during which the wind speed was below a given value. If the number of hours in a specific interval is included in the cumulative number of hours belonging to that interval then it is clear that we refer to the upper value of the interval for our calculations. The procedure now consists of plotting the percentages of the cumulative distribution as a function of the upper boundaries of their respective intervals on Weibull paper (Figure A.9). The result will be a number of dots lying more or less on a straight line. If the line is totally straight, the distribution perfectly fits a Weibull distribution. In many cases, however, the line will be slightly bent. Then the linearization should be focussed on the wind speed interval that is most interesting for our wind energy applications, i.e. between  $0.7 \bar{v}$  and  $2 \bar{v}$ .

In order to find  $k$ , draw a second line through the "+", marked "k-estimation point", and perpendicular to the Weibull line. The intersection of this second line with the linear  $k$ -axis on top of the paper gives the desired  $k$ -value. The  $c$ -value, if required, is simply the intersection of the Weibull line with the dotted line, marked "c-estimation". Ideally this procedure should be applied to the data for a number of years, not to data from one month only. If monthly  $k$ -values are required then the use of wind data from a number of identical months of subsequent years will give more reliable results.

If a considerable percentage of calm is found in the frequency distribution, the Weibull analysis should be applied only to the percentage of time during which the wind is blowing (reference 29).

For the reader's convenience a sheet of Weibull graph paper is included in Appendix E.

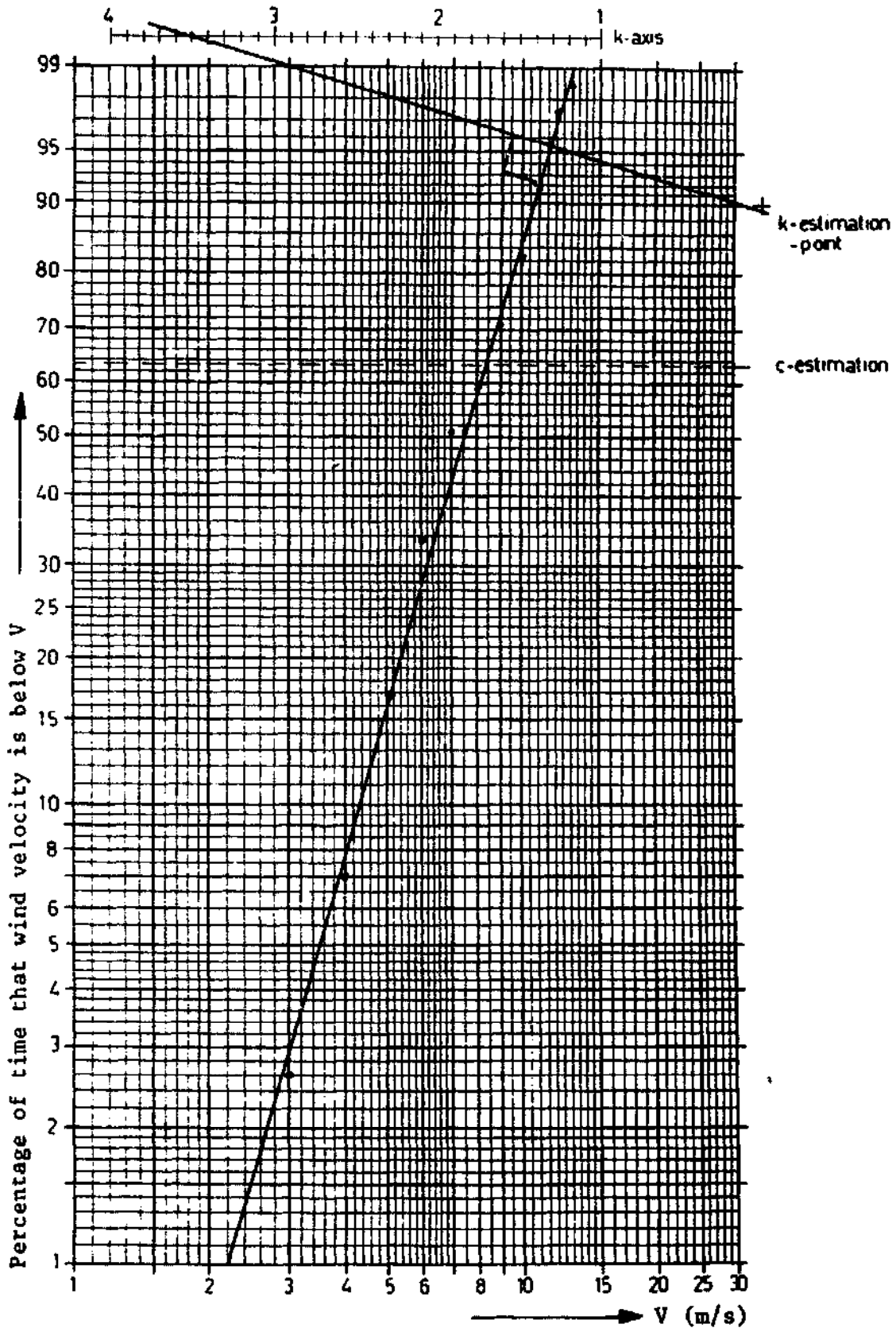
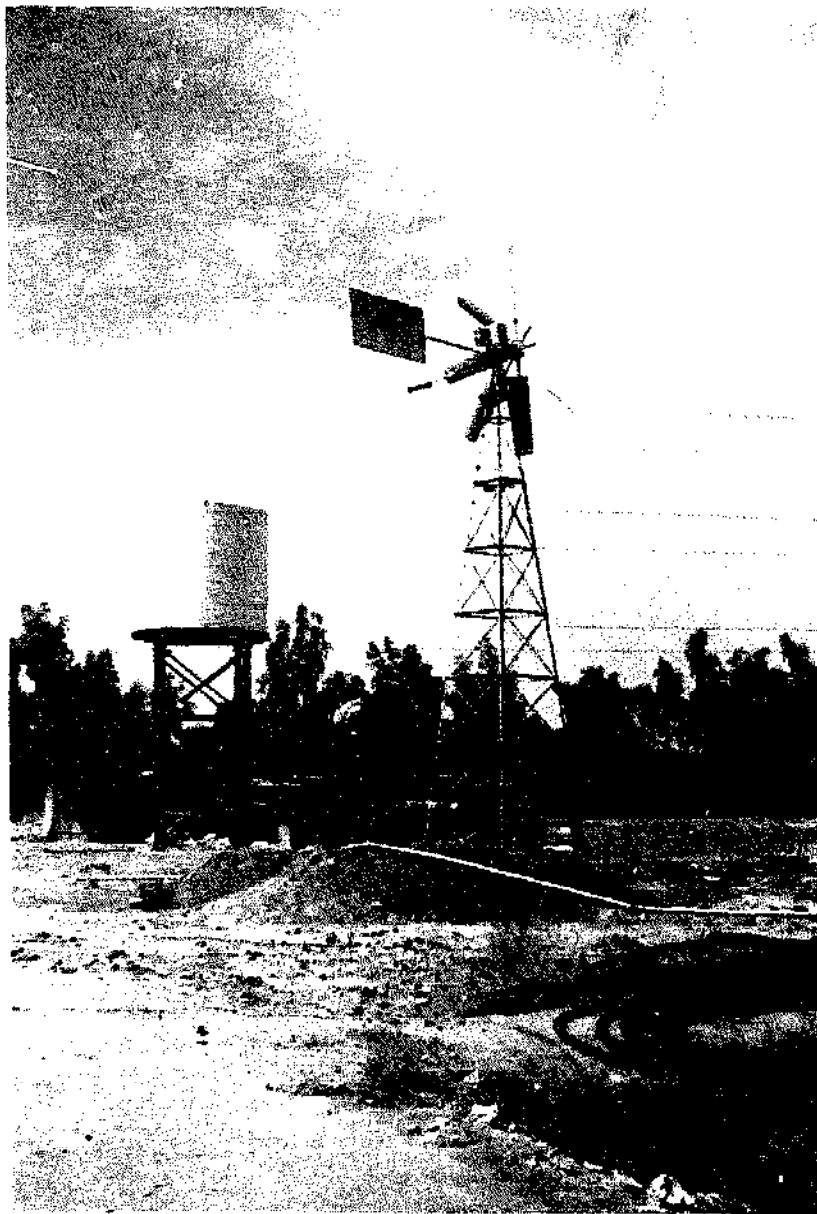

Figure A.9. The cumulative velocity distribution of the month June 1975, measured in Praia (Cape Verde), plotted versus the upper boundary of the respective wind speed intervals, to yield the value of the Weibull shape factor  $k$ . (Same data as Figure A.4).

## Appendix B

### DETAILS OF THE SIZING METHODOLOGY (output prediction)



*In setting up a wind pumping system, great care should be taken in sizing the system – wind pump, storage tank, pipelines – correctly for the required output. Oversizing would lead to unduly high water costs. Correct sizing implies that reliable methods are available to predict the hydraulic output of the system.*

## Appendix B

### DETAILS OF THE SIZING METHODOLOGY

#### (output prediction)

Before reading this appendix, the reader should become familiar with the contents of Chapters 2 and 3 of this handbook. The appendix is organized as follows: Section B.1 presents the equations and definitions underlying the sizing graphs of Chapter 3. Section B.2 presents a more complex method for reaching a compromise between output and output availability than the one given in Chapter 3. Section B.3 describes the output prediction model underlying the sizing methodology. Section B.4 discusses storage tank sizing.

### B.1. Equations used for sizing method of Chapter 3

#### Output and rotor size (Figure 3.3)

Figure 3.3 in Chapter 3 represents the basic relationship between average power production and the rotor diameter (see reference 3).

$$P_{hydr} = C_E (C_P \eta)_{max} \frac{1}{2} \rho A V^3 \tag{1}$$

where	$P_{hydr}$	average hydraulic power	(W)
	$C_E$	energy production coefficient	(-)
	$(C_P \eta)_{max}$	maximum overall power coefficient	(-)
	$\rho$	air density, usually 1.2	(kg/m <sup>3</sup> )
	$A$	rotor area = $\frac{1}{4} \pi D^2$	(m <sup>2</sup> )
	$D$	rotor diameter	(m)
	$V$	average wind speed	(m/s)

#### Matching of windmill and pump (Figure 3.4)

Figure 3.4 in Chapter 3 represents the matching of windmill and pump, which is most conveniently expressed in terms of the design wind speed (reference 3). The design wind speed can be calculated by equating the torque of wind rotor and pump in the design point:

$$V_d = \sqrt{\frac{\eta_{vol} V_s \rho_w g H \lambda_d i}{\rho \pi^2 R^3 (C_p \eta)_{max}}} \quad (2)$$

where:	$V_d$	design wind speed	(m/s)
	$\lambda_d$	design tip speed ratio	(-)
	$i$	transmission ratio, $i < 1$ for back geared windmills	(-)
	$\rho_w$	density of water	(1000 kg/m <sup>3</sup> )
	$H$	pumping height	(m)
	$\eta_{vol}$	volumetric efficiency, 0.8 to 1.0	(-)
	$V_s$	stroke volume $= \frac{1}{4} \pi D_p^2 s$	(m <sup>3</sup> )
	$D_p$	pump cylinder diameter	(m)
	$s$	pump stroke	(m)
	$g$	acceleration of gravity	(9.8 m/s <sup>2</sup> )
	$R$	radius of rotor = $\frac{1}{2} D$	(m)

## B.2. Complete sizing and output prediction methodology

In the description of the sizing methodology of Chapter 3 it was recommended — based on a reasonable compromise between power output and output availability — to match wind machine and pump according to Table 2.2 in Chapter 2. The table quantifies the matching in terms of  $V_d$ , the design wind speed. It presents the output in terms of  $C_E$ , the energy production coefficient.

In specific situations one may wish to deviate from this design, and apply a different matching, i.e. a different  $V_d$ . For such cases one may use the graphs in this appendix (Figure B.1) to determine the resulting  $C_E$ .

While Figure B.1 is a graph of the energy production coefficient  $C_E$ , Figure B.2 is a graph of output availability. Both graphs must be taken into account before choosing a final value for  $V_d$ . As already explained in Chapter 2, the matching of a windmill and a pump is always a compromise between output and output availability.

The output availability is defined as the percentage of time during which the windmill delivers more than  $1/10$  of its average output.

The quantitative values of availability should be used with great care. For example, an availability of 75% may seem high, but if it means continuous output during 9 months of the year and 3 consecutive months of zero output, it would be absolutely unacceptable for drinking water supply. An availability of 25% may seem low, but if it means 6 hours of output for each and every day, it may be adequate. In other words, the variation of availability over time must be considered specifically for each case.

Once the best compromise between output and availability has been determined, the procedure for sizing a windmill is rather straightforward. With the values for  $V_d/V$  and  $C_E$  found in this appendix, one can readily apply the graphical sizing method of Chapter 3, or apply the formulas of Section B.1 of this appendix.



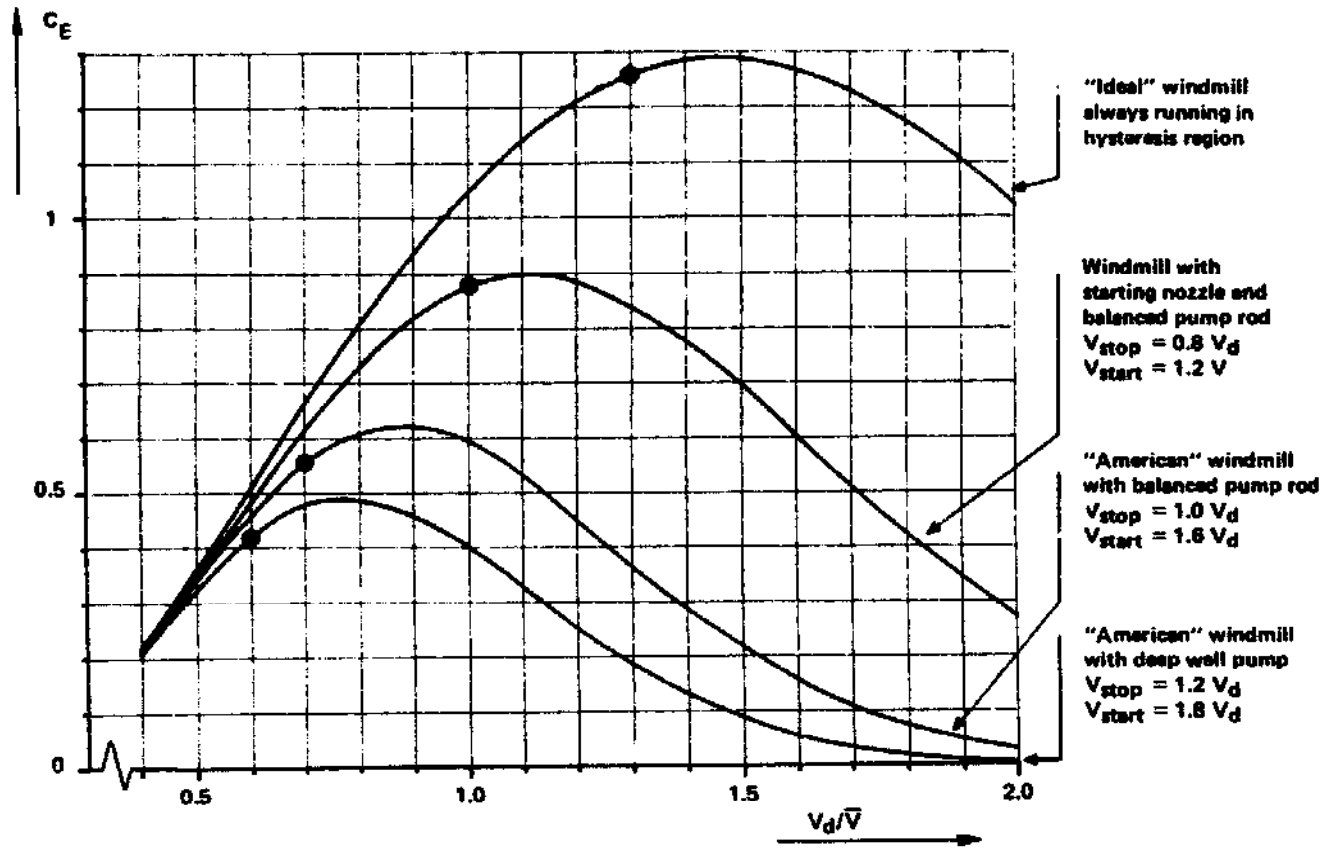

Figure B.1. Energy production coefficient as a function of design wind speed over average wind speed. Dots: reasonable design indicated in Table 2.2, Chapter 2.

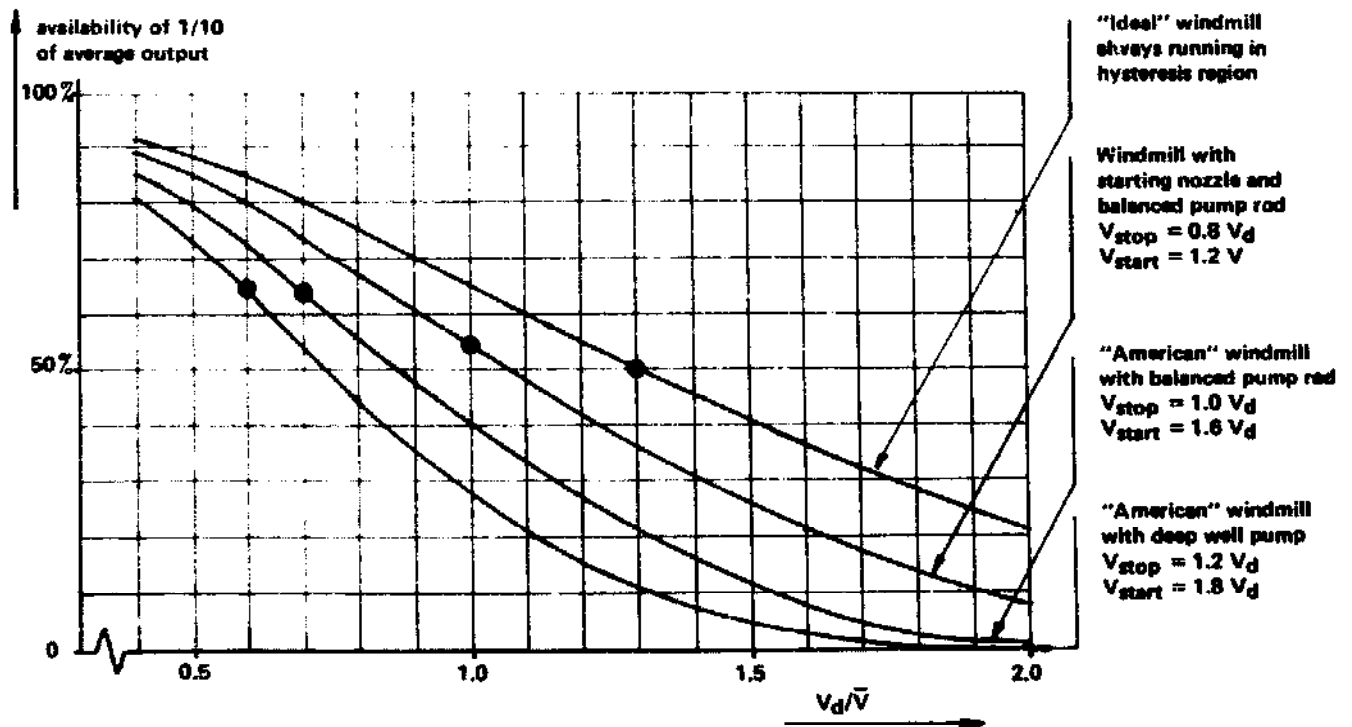

Figure B.2. Output availability of 10% of average output as a function of design wind speed over average wind speed. Dots: reasonable design according to Table 2.2, Chapter 2.

Note that the "reasonable" design as specified in Table 2.2 of Chapter 2, has been indicated with dots in the graphs. The  $V_d$  values lie somewhat below the values for maximum output. It is reasonable to sacrifice some output for a better availability.

Of course, the graphs in this appendix may also be used for output prediction. Especially for the other month than the design month this is interesting. The design wind speed of the windmill is known; the average wind speed for each month is known. Calculate the ratio  $V_d/V$  for each month. Determine the  $C_E$  value for each month (Graph B.1). Determine the output for each month with the corresponding  $C_E$  value using the nomogram in Figure 3.3 in reverse order.

### B.3. Output prediction model

The description of the model will be based on the concepts treated in the main text of this handbook, especially Chapter 2, Section 2.4 on the matching of windmills and piston pumps. The subject matter treated in Chapter 2 will not be repeated here.

The background to the model presented here, and a general description of it have been published earlier as contributions to conferences on wind energy (references 30 and 31).

#### Conventional method of output prediction of wind turbines (wind electric generators)

The total energy output of a wind turbine over a longer period of time depends both on the characteristics of the turbine and those of the site where it is installed. It is usual to separate the wind machine's characteristics and the site characteristics in the following way:

- o **Output curve of the wind turbine**, the relationship between power output of the turbine and wind speed. This is assumed to be a unique characteristic of a given wind turbine (with load), independent of site characteristics, universally applicable.
- o **Wind speed frequency distribution**, summarizing information on the wind regime of a certain site.

The total output at a certain site is calculated in two steps by "multiplying" the output curve and the frequency distribution, i.e. multiplying corresponding points and integrating the result (Figure B.3).

Recommendations of the International Energy Agency (IEA) for output performance testing (reference 32), which are generally accepted by the wind energy community, are based on this concept.

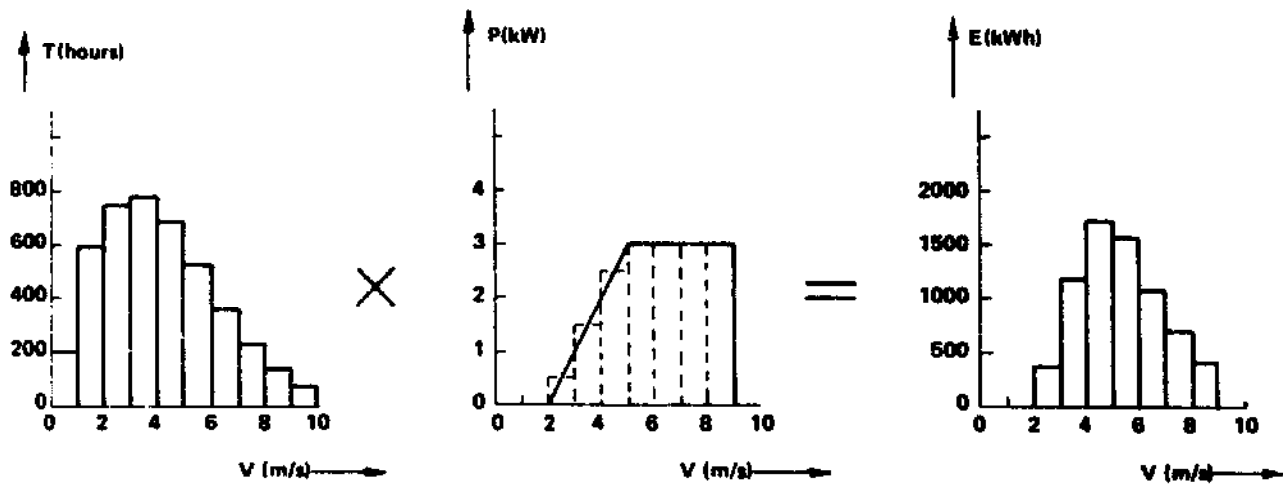

Figure B.3. Calculation of total output of a wind machine from the wind speed frequency distribution and the output curve (reference 3).

### Problem encountered with windmills driving piston pumps

As explained in Section 2.4, Chapter 2 and illustrated in Figure 2.9, the output curve of a windmill coupled to a piston pump has two branches between  $V_{stop}$  and  $V_{start}$ . In other words it has a hysteresis loop.

For wind speeds between  $V_{stop}$  and  $V_{start}$ , the windmill will sometimes be running and sometimes be standing still. In a specific situation the result will be an average, determined by the probability of either situation (Figure B.4).

This probability can be found by considering the history of the wind speed: Once the windmill is running it will continue doing so when it enters the hysteresis region. Once standing still, it will remain standing still when entering the hysteresis region. Therefore, the probability of either situation depends on the wind speed distribution. In strong winds the windmill will be running most of the time and the system will follow more often the upper branch of the hysteresis loop than the lower one. In weak winds the opposite is expected.

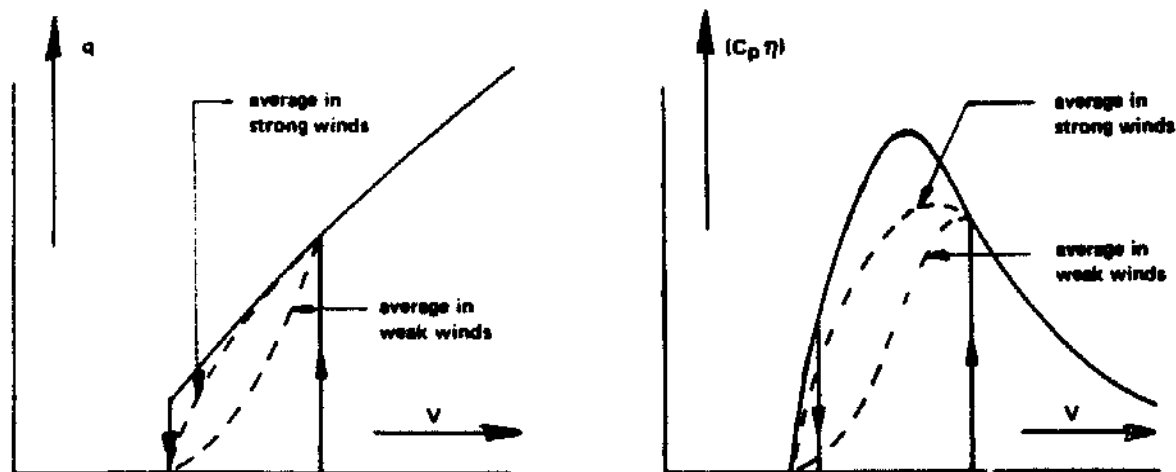

Figure B.4. Output performance of a windmill coupled to a piston pump. Output behaviour and average output curves.

This means that the output curve of a water pumping windmill depends both on the characteristics of the machine and on the wind regime of the site where it is installed. It is not possible to separate machine characteristics and site characteristics, as is usually done for wind turbines (see above).

### **New method for output prediction of windmills driving piston pumps**

Because of the problem depicted above, one must abandon the concept of a unique output curve generally applicable for any site. This conclusion is supported by results of field measurements (see references 30 and 31).

Instead of the conventional two-step procedure for output prediction (see above), a three-step procedure will be required for the calculation of total output of windmill driving piston pumps to lift water:

- o An output curve is determined including the two branches of the hysteresis loop. A theoretical model to do this can be rather simple (see below). A measuring procedure will be more complicated.
- o Using the actual wind speed frequency distribution of a certain site one calculates the probability of pumping in the hysteresis region and corrects the output to find a curve which is only applicable for this very site.
- o One then multiplies the (site specific) output curve with the site's wind speed frequency distribution.

The three-step procedure outlined briefly below has been executed in a generalized manner in order to obtain results that can be applied to various sizes and configurations of machines. It is described in detail in reference 35.

#### **Step 1. Output curve with hysteresis loop**

A more or less standard curve for the overall power coefficient ( $C_{P\eta}$ ) as a function of the wind speed  $V$  was derived for a wind pump with a conventional piston pump, or a pump with a starting nozzle (the latter designed for 10% energy loss at the design point, see reference 3). Both curves are shown in Figure B.5.

The problem of determining  $V_{stop}$  and  $V_{start}$  has been discussed extensively in references 30 and 31. Values of  $V_{stop}/V_d$  and  $V_{start}/V_d$  pertaining to various systems are given in Table B.1.

#### **Step 2. Site-specific output curve**

In reference 31 a simple model is given to estimate the probability of pumping between  $V_{stop}$  and  $V_{start}$ , assuming that the frequency distribution of the wind speed is a Weibull distribution with  $k=2$  (Appendix A). In the model the average wind speed  $\bar{V}$  can be varied with respect to  $V_{stop}$  and  $V_{start}$  (and  $V_d$ ).

With this model it is now possible to calculate a site-specific output curve for the different types of wind pumps indicated in Table B.1.

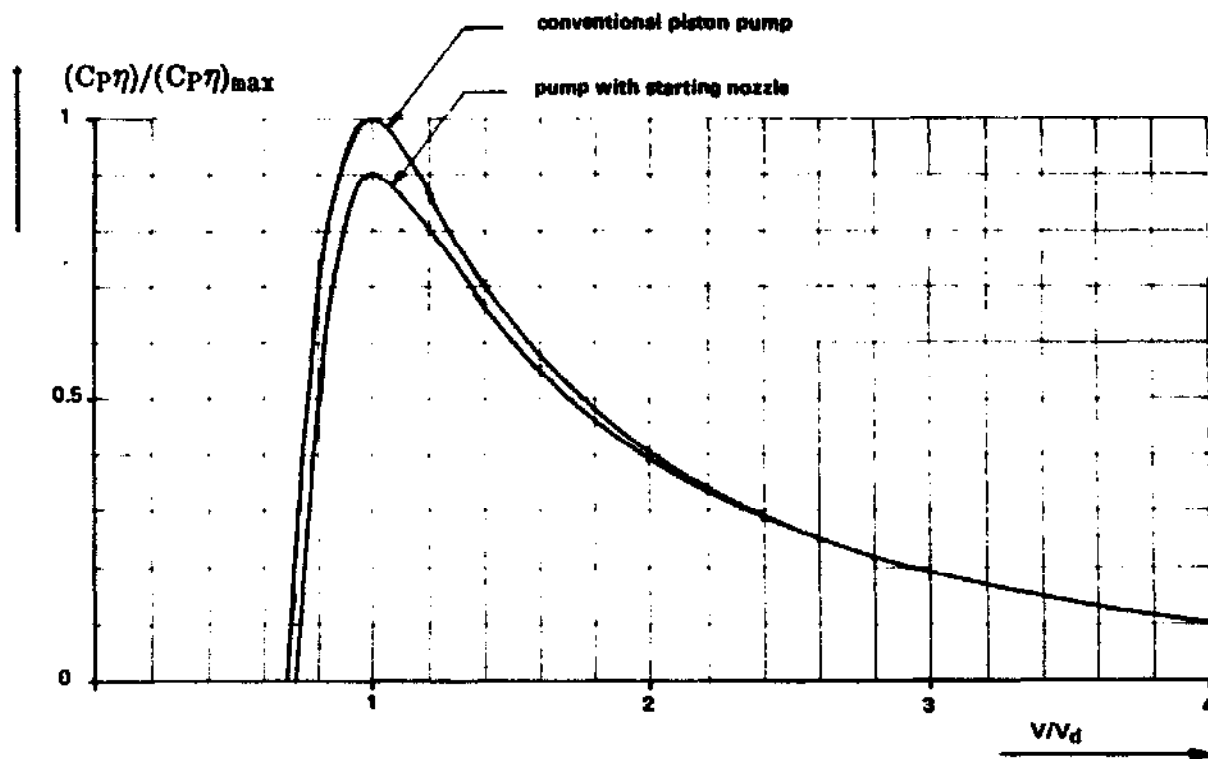

Figure B.5. Output curves used for the computations.

	$V_{stop}/V_d$	$V_{start}/V_d$
Classical slow running windmill with deep well pump	1.2	1.8
Classical slow running windmill with shallow well pump or balanced pump rod	1.0	1.6
Recent design with starting nozzle in pump and balanced pump rod	0.8	1.2
"Ideal" windmill, variable stroke, floating valve	0.7	0.7

Table B.1. Values of start and stop wind speeds related to design wind speed for various types of wind pumps.

### Step 3. Calculation of total output

Using the procedure illustrated in Figure B.3 and assuming a Weibull distribution for the wind speed, we can calculate the total output of the wind pump. The output availability can also be calculated.

The results on output are presented in a general form in Figure B.1, indicating the energy production coefficient  $C_E$  as a function of the choice of the design wind speed, expressed as the ratio  $V_d/V$  for different types of wind pumps. Figure B.2 shows the corresponding values of output availability.

## B.4. Storage tank sizing

The sizing of the storage tank has been treated in a rather simplified way in Chapter 3. When considering the full problem a compromise has to be established between wind pump size and storage tank size. This can be easily understood by taking an extreme case: If the wind pump were chosen large enough to supply all water required instantaneously, no storage would be required. However, this solution would hardly be economic, since the wind pump's capacity would not be fully exploited most of the time. It is more appropriate to use a smaller wind pump, and add a storage tank to supply water at times of peak demand.

Simulation studies have been performed concerning this problem (reference 33). Hour by hour simulations were made of wind pump output, water consumption, and storage of water in the tank, or retrieval of water from the tank. After performing several simulations for different tank sizes, a minimum tank size was determined on the basis of criteria for acceptable water deficits. This procedure was repeated for a range of wind pump exploitation factors  $f_{we}$ , i.e. the ratio of total yearly demand and total yearly output. The simulations were done for two quite different cases, with quite different wind regimes: Cape Verde, and Sri Lanka. Yet the results were rather similar, and are summarized in Figure B.6.

The graph in Figure B.6 may be used as the basis for an economic optimization of a wind pump system, once the specific costs of wind pump and storage tank are known. In the case of a relatively cheap windmill but an expensive storage tank, one will tend to be in the left part of the graph. For an expensive wind pump and a cheap tank one will shift to the right.

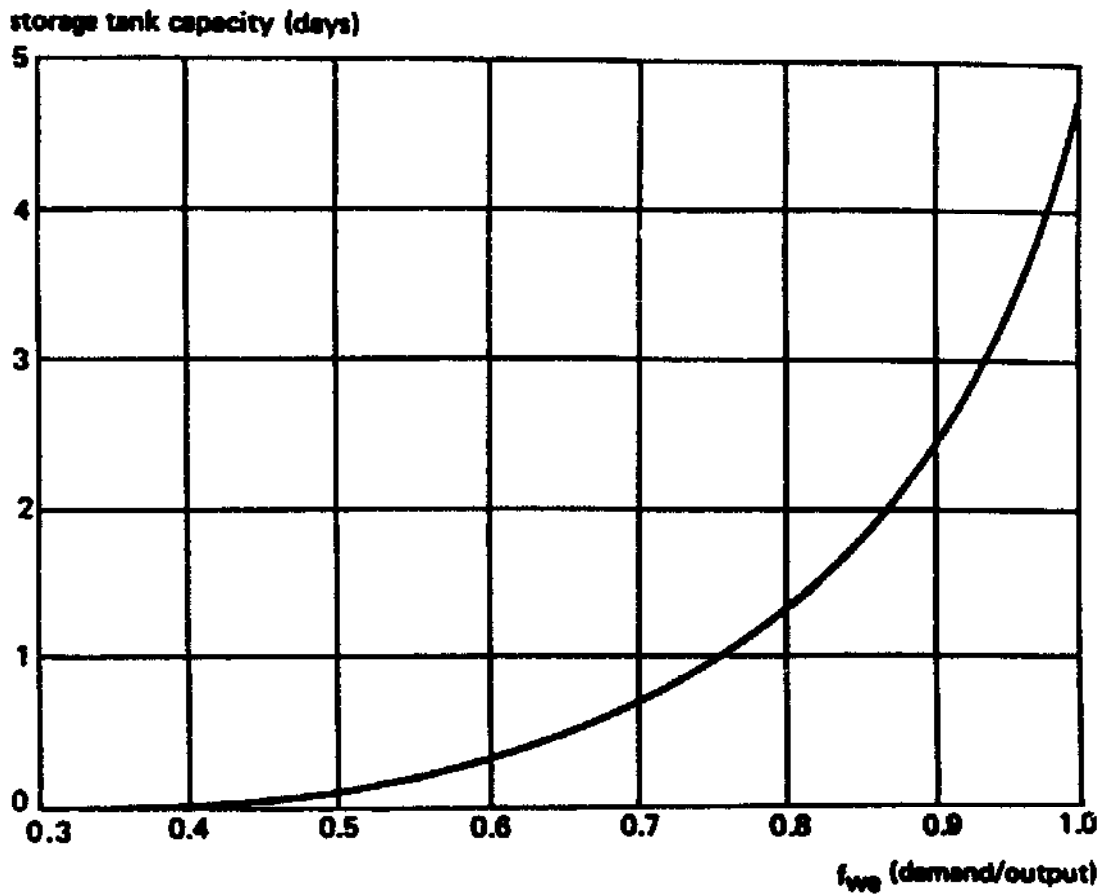

Figure B.6. The relationship between required storage tank capacity (in days) and the wind pump exploitation factor  $f_{we}$  (reference 33).

Appendix C  
SIMPLE METHOD OF CALCULATING COSTS  
OF WATER PUMPED BY A WIND PUMP,  
ENGINE-DRIVEN PUMP AND SOLAR PUMP



*At times the value of water is incalculable. A Mapel compressor windmill pumping from 80 meters by the air lift principle during a drought in the Northeast of Brazil.*



## Appendix C

### SIMPLE METHOD OF CALCULATING COSTS OF WATER PUMPED BY A WIND PUMP, ENGINE-DRIVEN PUMP AND SOLAR PUMP

In this appendix some simple formulas are derived to calculate and compare the costs of pumping water by a wind pump, an engine-driven pump and a solar pump. The costs are calculated in US \$ per kWh<sub>h</sub>, the latter being used as the unit for the effective hydraulic energy output. 1 kWh<sub>h</sub> is equivalent to 367 m<sup>4</sup> (see Section 1.2, Chapter 1). The costs of the water source, storage and distribution are not included in the calculations.

For calculating costs use is made of the annuity method. The method is simple and sufficiently accurate for small capital investments with a life time of 10 to 15 years or less (see Section 5.1 and 5.2, Chapter 5).

The capital costs of all three pumping systems are related to their specific investment, i.e. the investment per m<sup>2</sup> rotor area for a wind pump and per kW rated for an engine-driven pump (diesel or kerosene), and per W peak for a solar pump.

Maintenance and repair costs are split into three categories:

1. A fixed annual amount (e.g. travel costs of repair crew).
2. Annual costs proportional to the investment.
3. Annual costs proportional to the number of operating hours per year (e.g. of a diesel pump).

The costs of an operator have been left out of the calculations as they are more or less the same for all systems.

The reader who wants to skip the derivation can go directly to the final results (C.5, C.10 and C.15). Each is illustrated by an example, in which the parameters coincide with those from Section 5.4 and Figure 5.3, Chapter 5.

#### C.1. Costs of water pumped by a wind pump

Consider using a waterpumping windmill:

$E_{h,an}$  = annual hydraulic energy output requirement in kWh<sub>h</sub>/year

$P_{h,an}$  = average annual hydraulic power output requirement in kW<sub>h</sub>:

$$E_{h,an} = 8760 \times P_{h,an} \text{ in kWh}_h \tag{C.1}$$

$V_i$  = average monthly wind speed in month  $i$  ( $i$  from 1 to 12)

$P_{h,i}$  = average hydraulic power output requirement of wind pump in month  $i$  (in kW <sub>$i$</sub> ).

Using "rule of thumb" (1.4a, Chapter 1)

$$P_{h,i} = \beta V_i^3 A \cdot 10^{-3} \quad \text{kWh} \quad (C.2)$$

where A is rotor area

$\beta$  is quality factor (Table 2.2, Chapter 2)

The most critical month is that in which  $(P_{h,i}/V_i^3)$ , i.e. the energy demand in relation to available wind energy, is maximum. We will indicate these values in the critical month by an asterisk.

$V_i^*$  = the average wind speed in the critical month

$P_{h^*,i}$  = the average hydraulic power requirement in the critical month

Using (C.2), these values determine the rotor area  $A_d$  (design value)

$$\beta (V_i^*)^3 A_d \cdot 10^{-3} = P_{h^*,i} \quad (C.3)$$

with which the requirements in the critical month are met.

#### Capital costs per kWh<sub>h</sub>:

I is investment in \$.

Assume annual costs are given by annuity.

Annual costs  $\alpha I$ , in which  $\alpha$  is annuity factor, dependent on economic lifetime L, discount rate d and inflation rate i (see Table C.1).

Annual costs are  $\alpha I$  or equal to  $(\alpha SI A_d \text{ \$/year})$   
in which SI is the investment per m<sup>2</sup> rotor area ( $\text{\$/m}^2$ )

$C_c$  is capital costs per kWh<sub>h</sub> ( $\text{\$/kWh}_h$ )

$$C_c = \frac{\alpha (SI) A_d}{E_{h,an}}; \text{ substituting (C.1) and (C.3) gives}$$

$$C_c = 0.114 \frac{\alpha (SI)}{\beta (V_i^*)^3} \left[ \frac{P_{h^*,i}}{P_{h,an}} \right] \quad \text{\$/kWh}_h \quad (C.4)$$

#### Costs of maintenance and repair (MR) per kWh<sub>h</sub>:

Assume annual costs of MR can be split up into a constant part M and one proportional to the investment. So costs are  $(M + \mu I)$ , in which  $\mu$  indicates cost of MR per \$ investment. In the same way as with the capital costs we find a similar expression as (C.4) for  $C_{MR}$

The total costs  $C_{tot} (= C_c + C_{MR})$  are

$$C_{tot} = 0.114 \left\{ \frac{(\alpha + \mu) (SI)}{\beta (V_i^*)^3} \left[ \frac{P_{h,i}^*}{P_{h,an}} \right] + \frac{M \cdot 10^{-3}}{P_{h,an}} \right\} \quad \$/kWh_h \quad (C.5)$$

**Example:**

Capital: Specific investment: US \$ 400.-/m<sup>2</sup>  
 Life time: 15 years } annuity factor  $\alpha = 0.1315$   
 Real interest rate: 10% } (see Table C.1)  
 Maintenance and repair:  
 M = US \$ 50.-/year (fixed annual cost)  
 $\mu = 5\%$  (percentage of investment)  
 Quality factor of performance:  $\beta = 0.08$   
 Demand:  $P_{h,i}^*/P_{h,an} = 1$  (constant demand throughout year)

Results are plotted in Figure 5.3.a, Chapter 5, e.g.  $P_{h,an} = 0.042 \text{ kW}_h$  (equivalent to 1 kWh<sub>h</sub> per day) and  $V^* = 3 \text{ m/s} \rightarrow \text{US } \$ 3.97 \text{ per kWh}_h$ .

## C.2. Costs of water pumped by an engine-driven pump

Consider a diesel or kerosene pump:

- $P_{er}$  = rated power of the engine in kW
- $P_e$  = power level at which engine actually operates
- $r$  =  $P_e/P_{er}$  = derating factor
- $\eta_e$  = efficiency of the engine (from fuel to shaft power)
- $P_p$  = power output of the pump in kW
- $\eta_p$  =  $P_p/P_e$  = efficiency of the pump
- $P_h$  = effective hydraulic power output in kW<sub>h</sub> ( $P_h = \rho \cdot gH \cdot q \cdot 10^{-3} \text{ kW}$  in which  $q$  = volume flow rate in m<sup>3</sup>/s)
- $P_l$  = power losses in suction and delivery lines
- $P_p$  =  $P_h + P_l = P_h (P_h + P_l) / P_h$
- $\eta_l$  =  $P_h / (P_h + P_l)$  = "efficiency" of suction and delivery lines
- $P_h$  =  $\eta_p \cdot \eta_l \cdot P_e$  in kW
- $T_{an}$  = number of hours that engine operates per year
- $E_{h,an}$  =  $P_h T_{an} = \eta_p \cdot \eta_l \cdot P_e \cdot T_{an}$  = annual hydraulic energy output in kWh<sub>h</sub> per year

(C.6)

**Fuel costs per kWh<sub>h</sub>:**

$$\begin{aligned}
 E_f &= \text{energy contained in fuel in kWh} \\
 &= V_f \cdot \text{SEF in which } V_f = \text{volume of fuel in liters and SEF is energy content of} \\
 &\quad \text{1 liter of fuel} \\
 E_h &= \text{effective hydraulic energy output in kWh}_h \text{ from } V_f \text{ liters of fuel with energy} \\
 &\quad \text{content } E_f \\
 &= \eta_e \cdot \eta_p \cdot \eta_l \cdot V_f \cdot \text{SEF} \quad \text{in kWh}_h
 \end{aligned}$$

Fuel costs are:  $V_f \cdot \text{SFC}$  in which SFC = specific fuel costs in \$ per liter

$$C_f = \text{costs of fuel per kWh}_h$$

$$C_f = \frac{\text{SFC}}{\text{SEF}} \frac{1}{\eta_e \eta_p \eta_l} \quad \text{(C.7)}$$

SEF is approx. 10 kWh per liter

$$C_f = \frac{1}{10} \frac{\text{SFC}}{\eta_{\text{tot}}} \quad \$/\text{kWh}_h$$

in which  $\eta_{\text{tot}} = \eta_e \cdot \eta_p \cdot \eta_l =$  the total efficiency of conversion from fuel energy to effective hydraulic energy

**Costs of maintenance and repair (MR) per kWh<sub>h</sub>:**

Assume costs of MR are directly proportional to hours of operation of the engine. The engine operates  $T_{\text{an}}$  hours per year.  $\tau$  is cost in \$ of MR per 1000 hours.

Annual costs of MR:  $\tau \cdot T_{\text{an}} \cdot 10^{-3}$ ; with annual energy output according to (C.6), we find for the costs of MR per kWh<sub>h</sub>:

$$C_m = \frac{\tau \cdot 10^{-3}}{\eta_p \eta_l P_e} \quad \$/\text{kWh}_h$$

**Capital costs per kWh<sub>h</sub>:**

$I$  is investment in \$.

Assume annual costs are given by annuity (see Table C.1).

The annual costs  $C_c$  of the capital investment per kWh<sub>h</sub> are:

$$C_c = \frac{\alpha I}{E_{h,\text{an}}} \quad \$/\text{kWh}_h \quad \text{(C.9)}$$

or expressed in  $T_{\text{an}}$  with the aid of (C.6)

$$C_c = \frac{\alpha (SI)}{\eta_p \eta_l r T_{\text{an}}}$$

in which

$$SI = \frac{I}{P_{er}} = \text{specific investment (\$ per kW rated)}$$

Summarizing: total costs  $C_{tot}$  per  $kWh_h$  are given by:

$$C_{tot} = \frac{1}{10} \frac{SFC}{\eta_{tot}} + \frac{\tau \cdot 10^{-3}}{\eta_p \eta_l P_e} + \frac{\alpha I}{E_{h,an}} \quad \$/kWh_h \quad (C.10a)$$

or

$$C_{tot} = \frac{1}{10} \frac{SFC}{\eta_{tot}} + \frac{\tau \cdot 10^{-3}}{\eta_p \eta_l P_e} + \frac{\alpha (SI)}{\eta_p \eta_l r T_{an}} \quad \$/kWh_h \quad (C.10b)$$

**Example:**

**Assume:** Annual average daily hydraulic energy requirement is 1  $kWh_h$  per day.  
 Consider diesel or kerosene/gasoline pump.  
 Rating and life time:  $r = 0.5$ ;  $\eta_p \eta_l = 0.4$ .  
 250 days operation per year  $\rightarrow$  1.4  $kWh_h$  per operating day.

**Diesel:** 2.5 kW (smallest available)  $\rightarrow P_e = 1.25$  kW  $\rightarrow P_h = \eta_p \eta_l P_e \rightarrow$   
 $P_h = 0.5$   $kWh_h \rightarrow$  2.92 hours/day  $\rightarrow$  730 hours/year  $\rightarrow$   
 lifetime 13.7 years.  
 Take 14 years.

**Kerosene:** 4 hours/day  $\rightarrow P_e \eta_p \eta_l = 1.4/4 \rightarrow P_e = 0.9125$  kW  $\rightarrow$   
 $P_{er} = 1.825$  kW 1000 hours/year  $\rightarrow$  lifetime 5 years.

**Fuel costs:** Assume SFC = \$ 0.35/l.

**Diesel:**  $\eta_{tot} = 0.1 \rightarrow C_f = \$ 0.35/kWh_h$

**Kerosene:**  $\eta_{tot} = 0.05 \rightarrow C_f = \$ 0.70/kWh_h$

**Costs maintenance and repair:** assume  $\tau = \$ 200/1000$  hours.

**Diesel:**  $C_{MR} = \$ 0.40/kWh_h$

**Kerosene:**  $C_{MR} = \$ 0.55/kWh_h$ .

**Capital costs:** assume real interest is 10%.

**Diesel:**  $\alpha = 0.136$ ,  $SI = \$ 600/kW \rightarrow C_c = \$ 0.56/kWh_h$

**Kerosene:**  $\alpha = 0.264$ ,  $SI = \$ 400/kW \rightarrow C_c = \$ 0.53/kWh_h$

**Total costs:** diesel \$ 1.31/ $kWh_h$  ; kerosene \$ 1.78/ $kWh_h$  (See Figure 5.3, Chapter 5, lowest values for diesel and kerosene).

### C.3. Costs of water pumped by a solar pump (reference 1)

Consider a solar pump:

$P_{er}$  is by definition the (electric) peak power output in kW<sub>p</sub> of a solar cell array at 25°C ambient temperature at a solar irradiation intensity of 1 kW/m<sup>2</sup>.

$H_s$  is the solar irradiation per m<sup>2</sup> in a day expressed in kWh/m<sup>2</sup>.day

$T_s$  is the total solar irradiation expressed as the equivalent-number-of-hours-per-day of solar irradiation at a value of 1 kW/m<sup>2</sup>. In other words the value of  $T_s$  is equal to the value of  $H_s$ , if the latter is expressed in kWh/m<sup>2</sup>.day.

The total electric energy output of the solar cell array in a day is ( $P_{er} \cdot T_s \cdot 1/c$ ) kWh/day, in which  $c$  is a correction factor for higher ambient temperature  $\pm 40^\circ\text{C}$  and impedance mismatch (reference 1).

$\eta_s$  = daily energy subsystem efficiency, i.e. the ratio of hydraulic output energy to electrical input energy over a day.

$E_h$  = hydraulic energy requirement in kWh<sub>h</sub> per day

To fulfil these requirements we find:

$$E_h = \eta_s P_{er} T_s 1/c \quad \text{kWh}_h/\text{day} \quad (\text{C.11})$$

In a similar way as shown for a wind pump, the critical month, indicated by an asterisk, is the month for which  $E_h/H_s$  is maximum, or  $E_h/T_s$  is maximum.

Using (C.11) the rating of the array needed is determined by the values of  $T_s$  and  $E_h$  in the critical month

$$P_{er} = c \left\{ \frac{E_h}{T_s} \right\}^* \frac{1}{\eta_s} \quad \text{kW} \quad (\text{C.12})$$

Capital costs per kWh<sub>h</sub>:

$I$  = investment in \$

Assume annual costs are given by annuity.

$$C_c = \frac{\alpha I}{E_{h,an}} \quad \$/\text{kWh}_h \quad (\text{C.13})$$

$E_{h,an}$  = total hydraulic energy requirement in a year

$E_h$  = annual average daily hydraulic energy requirement per day;  $E_{h,an} = 365 \cdot E_h$

Substituting (C.12 and 14) in (C.13) and taking  $c = 1.2$  (reference 1),

$$C_c = 3.3 \frac{\alpha (SI)}{\eta_s} \cdot \left\{ \frac{E_h^*}{E_h} \right\} \cdot \frac{1}{T_s^*} \quad \$/\text{kWh}_h$$

in which (SI) is the specific investment in \$ per peak Watt.

**Costs of maintenance and repair (MR):**

Assume costs can be split up into three parts:

- a. Constant annual cost M (\$/year).
- b. Annual cost proportional to the investment (and so to the rating):  $\mu I$ .
- c. Cost of MR of the motor/pump proportional to the number of running hours:  
K\$ per 1000 hours

With  $n$  = number of running hours per year we find

$$C_{MR} = \frac{M + \mu I + K.n 10^{-3}}{E_h, a n} \quad \$/kWh_h$$

$n$  can be estimated using

$$n = \frac{365 E_h c}{\eta_s P_{er}}$$

$n$  being the equivalent number of hours that the installation operates at peak power with an efficiency  $\eta_s$ .

Relating  $P_{er}$  to the critical month via (C.12), and adding capital costs (C.14), the total costs are:

$$C_{tot} = 3.3 \frac{(\alpha + \mu) (SI)}{\eta_s} \left\{ \frac{E_h^*}{E_h} \right\} \frac{1}{T_s^*} + 2.74 \times 10^{-3} \frac{M}{E_h} + \frac{K}{1000} \left\{ \frac{E_h}{E_h^*} \right\} T_s^* \frac{1}{E_h} \quad \$/kWh_h$$

**Example:**

- Life time: 15 years
- Real interest: 10%
- Specific investment SI: US \$ 18.- per W peak
- Solar irradiation in critical month: 4 kWh/m<sup>2</sup> day  $\rightarrow T_s^* = 4$  hours
- Daily energy subsystem efficiency  $\eta_s = 0.40$ .
- Demand:  $E_h^*/E_h = 1$  (constant demand throughout the year).
- Fixed annual cost of maintenance and repair:  $M = US \$ 50.-/year$ .
- Maintenance and repair per 1000 hours of operation:  $K = US \$ 12.-/1000$  hours.
- Maintenance and repair as percentage of the total investment:  $\mu = 0.01$ .

We find for annual average daily demand  $E_h = 1$  kWh/day:

$$C_{tot} = 5.25 + 0.137 + 0.048 = US \$ 5.44/kWh_h. \text{ (See Figure 5.3.a, Chapter 5).}$$

### C.4. The annuity factor

The annuity factor is given by  $\frac{r}{1 - (1 + r)^{-n}}$

in which  $r$  is (real) interest rate  
 $n$  is lifetime (years)

Years	$r = 2$	3	4	5	6	7	8	10	12
1	1.0200	1.0300	1.0400	1.0500	1.0600	1.0700	1.0800	1.1000	1.1200
2	.51505	.52261	.53020	.53780	.54544	.55309	.56077	.57619	.59170
3	.34675	.35353	.36035	.36721	.37411	.38105	.38803	.40211	.41635
4	.26262	.26903	.27549	.28201	.28859	.29523	.30192	.31547	.32923
5	.21216	.21835	.22463	.23097	.23740	.24389	.25046	.26380	.27741
6	.17853	.18460	.19076	.19702	.20336	.20980	.21632	.22961	.24323
7	.15451	.16051	.16661	.17282	.17914	.18555	.19207	.20541	.21912
8	.13651	.14246	.14853	.15472	.16104	.16747	.17401	.18744	.20130
9	.12252	.12843	.13449	.14069	.14702	.15349	.16008	.17364	.18768
10	.11133	.11723	.12329	.12950	.13587	.14238	.14903	.16275	.17698
11	.10218	.10808	.11415	.12039	.12679	.13336	.14008	.15396	.16842
12	.09456	.10046	.10655	.11283	.11928	.12590	.13270	.14676	.16144
13	.08812	.09403	.10014	.10646	.11296	.11965	.12652	.14078	.15568
14	.08260	.08853	.09467	.10102	.10758	.11434	.12130	.13575	.15087
15	.07783	.08377	.08994	.09634	.10296	.10979	.11683	.13147	.14682
16	.07365	.07961	.08582	.09227	.09895	.10586	.11298	.12782	.14339
17	.06997	.07595	.08220	.08870	.09544	.10243	.10963	.12466	.14046
18	.06670	.07271	.07899	.08555	.09236	.09941	.10670	.12193	.13794
19	.06378	.06981	.07614	.08275	.08962	.09675	.10413	.11955	.13576
20	.06116	.06722	.07358	.08024	.08718	.09439	.10185	.11746	.13388
25	.05122	.05743	.06401	.07095	.07823	.08581	.09368	.11017	.12750
30	.04465	.05102	.05783	.06505	.07265	.08059	.08883	.10608	.12414
40	.03656	.04326	.05052	.05828	.06646	.07501	.08386	.10226	.12130
50	.03182	.03887	.04655	.05478	.06344	.07246	.08174	.10086	.12042
60	.02877	.03613	.04470	.05283	.06188	.07123	.08080	.10033	.12013

Table C.1. Annuity factor as a function of interest rate and lifetime



## Appendix D EXAMPLES

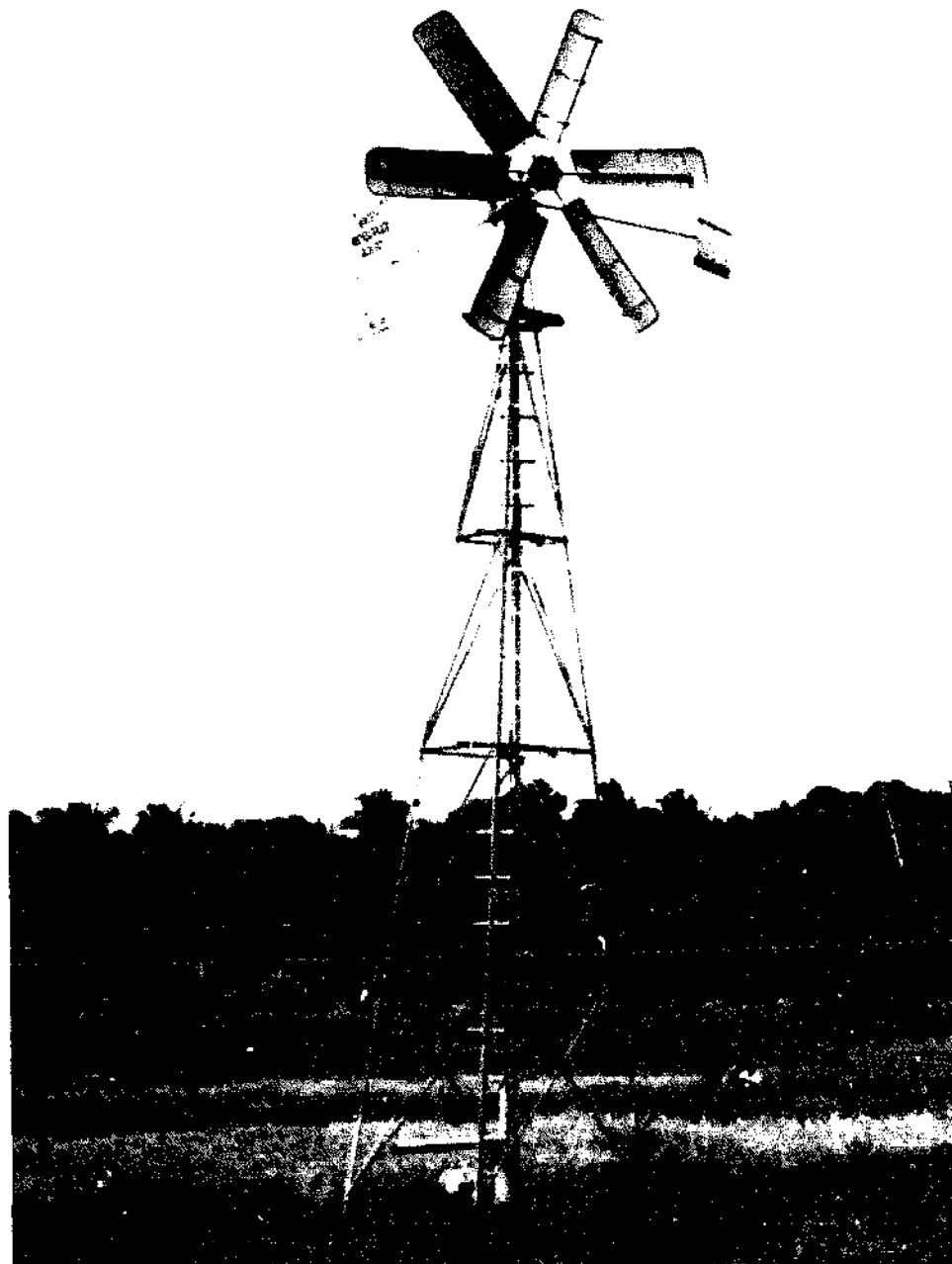

*Small scale wind pump irrigation in Sri Lanka.*

## Appendix D

### EXAMPLES

Two examples are presented, based on information from practical experience. The procedures outlined in Chapters 3 (site evaluation) and 5 (financial assessment) are elaborated for both examples.

#### Example D.1. Irrigation in the dry zone of Sri Lanka

This example concerns a typical small farm in the dry N.E zone of Sri Lanka. The information presented here is based on the practical experiences of a series of windmill pilot projects, especially that at Morawewa (north-east coast). The information was derived mainly from references 19, 20, 21, and 22.

Two different pumping devices are considered:

- a. a wind pump, as applied in the pilot projects
- b. a kerosene pump, commonly applied in the dry zone.

The following technical and economic information is to be used:

Cropping pattern:	See figure D.1 (from reference 20). During the wet Maha season (October to January) no lift irrigation is needed, and paddy rice is cultivated. During the dry Yala season (February to September) lift irrigation is practiced for growing "subsidiary food crops". Note that only part of the farm is used during this season in order to minimize risks.
Crop water requirements:	See Table D.1 (from reference 20). Note that the indicated crop water requirements are conservative estimates, since fully developed crops were assumed for the calculations, whereas crops in their initial phase of development will consume less water.
Water distribution:	Earth channels.
Irrigation method:	Furrow or basin.
Overall irrigation efficiency:	60%.
Water source:	Open well, water level at 5 m below ground level.

Usual type of tank:	Low round tank of bricks, lined on the inside with bitumen, and strengthened on the outside by earth bund, height approximately 1.5 m.	
Wind regime:	In the area of interest only one station has long-term records: Anuradhapura. However, the anemometer there is poorly exposed to the wind. Short-term measurements have been performed (reference 19).	
Terrain, landscape:	Flat, isolated trees.	
Pumping options:	Windmill or kerosene pump	
Cost of windmill:	Type:	WEU II/3, 3 m diameter, $\lambda_d = 2$ , manufactured in Sri Lanka.
	Purchase:	13,000 Rs US \$ 570*
	Installation:	3,000 Rs US \$ 130
	Lifetime:	10 years
	Maintenance:	5% of total investment per year
Cost of storage tank:	Type:	earth-brick-bitumen, capacity: 23 m <sup>3</sup>
	Investment:	5,000 Rs US \$ 220
	Lifetime:	10 years
	Maintenance:	3% of investment per year
Cost of engine-driven pump	Type:	1.9 HP kerosene motor, driving a centrifugal pump, capacity 9.1 m <sup>3</sup> /hr at 7 m head, kerosene consumption 1.3 l/hr.
	Purchase:	3,700 Rs US \$ 160
	Pipes, misc.:	680 Rs US \$ 30
	Installation:	820 Rs US \$ 40
	Lifetime:	5,000 operating hours
	Maintenance:	20% of investment per 1,000 operating hours
	Kerosene:	6.7 Rs/l US \$ 0.29/l
Well:	Investment:	3,000 Rs US \$ 130
	Lifetime:	10 years
Interest rate:	12.5% *	

\* All costs (and interest rate) indicated here are for mid 1983 (1 RS = US \$ 0.044)

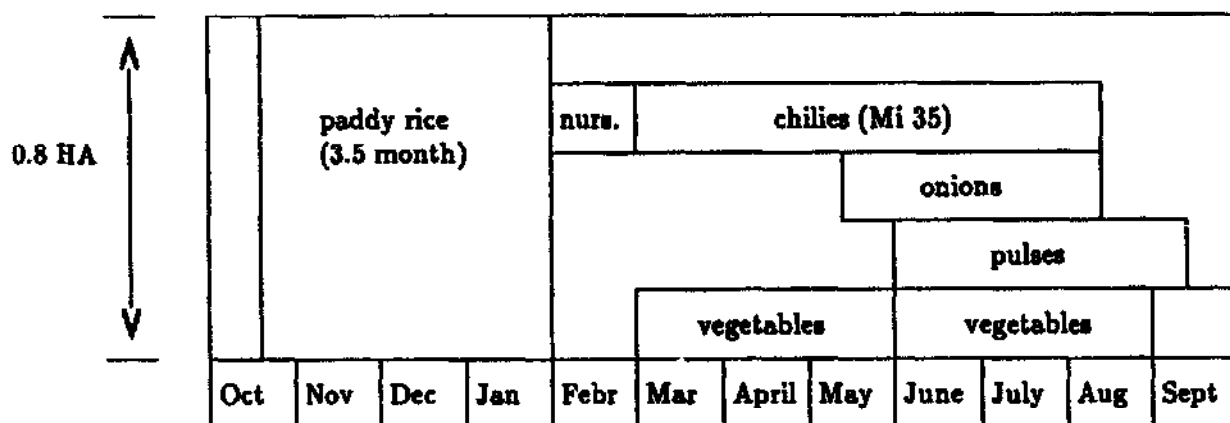

Figure D.1. Cropping pattern of a typical small farm in the dry zone of Sri Lanka, using either a wind pump or a kerosene pump during the dry season (February to September), reference 19.

	J	F	M	A	M	J	J	A	S	O/N/D
reference evapotransp.(mm/day)	3.4	4.1	4.9	4.9	5.4	6.5	6.6	6.7	5.9	rains
75% probability rainfall (mm/day)	2.0	0.5	0.6	2.3	1.7	0.3	0.3	0.3	0.6	-
NIR (m <sup>3</sup> /day/ha)	14	36	43	26	37	62	63	64	53	-
GIR (m <sup>3</sup> /day/ha)	23	60	72	43	62	103	105	107	88	-
actual cultivated area (ha) cropping pattern of Figure D.1	-	.10	.10	.20	.25	.40	.40	.30	.15	-

Table D.1. Irrigation requirements and cultivated area of small farm in dry zone of Sri Lanka, reference 19.

NIR = net irrigation requirement, GIR = gross irrigation requirement

The procedures for sizing and cost estimation of the windmill have been carried out by filling in the format sheets as indicated in Chapters 3 and 5. The completed format sheets are shown on the following pages, Tables D.2 to D.6.

### **Hydraulic power requirements**

The last two lines of Table D.1, gross irrigation requirement and cultivated area, are multiplied to find the pumped volume requirement, which is filled in the first column of the format sheet, in Table D.2.

The pumping height is found by adding the depth of the water level in the well and the height of the tank, total 6.5 m.

Since the distance between wind pump and tank is very short, the pressure loss in the delivery pipe is very low.

The average hydraulic power requirement is calculated with the formula given in Section 3.1.3, Chapter 3.

### **Wind power resources**

Reference 19 presents reasonable estimates for the actual wind speed at 10 m height above terrain, obtained from short term measurements.

Since an estimate of the actual wind speed is available, the first column of the data sheet in Table D.3 (concerning potential wind speed) is used to indicate the actual wind speed at 10 m height above terrain. The roughness of the terrain (isolated trees, tall crops) is estimated to be 0.25 m. Using the formula of Appendix A.3, the data for 10 m above terrain height are converted into 12 m data (tower height, see below). In the last column the specific wind power is calculated using the formula of Section 3.2, Chapter 3. Since the example site is at sea level the density of air is  $1.2 \text{ kg/m}^3$ .

### **Identification of design month**

As explained in Section 3.3, Chapter 3, the data of the previous format sheets are filled in in the format sheet for design month identification, Table D.4. Subsequently the ratio of average hydraulic power to specific wind power is calculated to give the reference area. The highest value is found for April, which is therefore the design month.

### **Wind pump system sizing**

The five steps indicated in the format sheet of Table D.5 must be carried out.

The tower must be high enough to lift the rotor over the isolated trees in the surroundings. A height of 12 m is chosen, which is the standard height for the type of windmill involved. From Table 2.2 one finds values for the energy production coefficient of 0.9 and for the maximum overall power coefficient of 0.18. Using the graph in Figure 3.3, Chapter 3, one

finds a rotor diameter of 3.4 m. For practical application, one chooses the standard diameter of 3.0 m, thereby accepting some lack of water in April.

Subsequently one must decide on the design wind speed. A value of 2.5 m/s is chosen, somewhat higher than the average wind speed in the critical month. By this choice the output is somewhat increased, but also the percentage of standstill is increased. This is acceptable since a strong diurnal variation of the wind speed was found during the low wind period of February to April. This means that the windmill will often be standing still during the night, but will mostly run during the day.

Using the graph of Figure 3.4 one finds a stroke volume for the pump of 0.41 l. This may be realized by taking a pump of 100 mm diameter and a stroke of 50 mm (giving a stroke volume of 0.39 l.).

Since the design wind speed was not chosen exactly according to the procedure of chapter 3 (see above), it is wise to check the energy production in the design month (April) and the month of highest demand (July). This may be done using Appendix B.2.

In April one finds a strong diurnal variation of the wind speed: relatively strong wind during the day (about 3 m/s), and calm during the night (about 1 m/s). For the daytime one finds a ratio of design over average wind speed of 0.83, an energy production coefficient of 0.76, and an average power of 16 W. During the night the wind pump will be standing still. Hence, the overall average power will be some 8 W, which is sufficient.

For July one finds a ratio of design over average wind speed of 0.53, an energy production coefficient of 0.39 and an average energy production of 31 W, which is approximately as required.

For the storage tank one chooses a storage capacity of half a day of water requirement during the month of highest need, July, giving 20 m<sup>3</sup>. This allows all water pumped during the night to be used the following day. For practical application one takes 23 m<sup>3</sup> which is the size of a standard design.

### **Wind pump performance specification**

Using the information above, the performance specification sheet may be completed in a straightforward way (Table D.6).

### **Unit water cost for a wind pumping system**

Using the information presented above, the last sheet may be completed in a straightforward way (Table D.7).

Note that the annual water requirement is found by multiplying the last two lines of Table D.1 (gross irrigation requirement and cultivated area), multiplying by the number of days in each month, and adding the two totals. The cost of operation is taken to be zero, since it is part of the normal work on the farm, involving no additional costs.

Finally a water cost of 4.6 \$cts/m<sup>3</sup> is obtained.

### **Unit water cost for a kerosene pump**

Subsequently the water costs of a kerosene pump are calculated using the format sheet for unit water costs (Table D.8).

In this case the design month is the month of highest hydraulic power requirement: July.

Assume 6 hours of operation per day, a derating factor of 0.5 and a pump efficiency of 25%. From the graph of figure 4.3, one finds a rated power of 1.1 kW. Practically one takes the usual type of pump: 1.98 HP or 1.4 kW.

The efficiency of the pump seems rather low (1.4%), but it is justified by the data of the 1.98 HP pump (see above), which were derived from practical tests. It is assumed that the same cropping pattern is applied as for the wind pump. Hence the annual water requirement is similar: 5060 m<sup>3</sup>. In order to pump this amount of water the kerosene pump will be operated 560 hours per year (at a flow rate of 9.1 m<sup>3</sup>/hr). Therefore the lifetime of 5,000 hours is equivalent to 9 years. The cost of operation represents the fuel consumption of the pump. Finally the water cost is found to be 6.0 \$ cts/m<sup>3</sup>.

It may be concluded that wind pumps are somewhat more economic than engine-driven pumps. This is due to special circumstances in the example: the windmill is extremely cheap (about \$100/M<sup>2</sup>), owing to the cheap local labor and steel prices far below world market prices. Over the last years the prospects for wind pumps have improved further as a result of a considerable increase in the cost of engine-driven pump sets.

HYDRAULIC POWER REQUIREMENTS					
Location. <b>DRY ZONE, SRI LANKA</b> .....					
Delivery pipe head loss.. <b>5</b> ...%      Delivery pipe length.. <b>10</b> ...m					
Month	Pumping requirement (m <sup>3</sup> /day)	Pumping height (m)	Head loss (m)	Total head (m)	Average hydraulic power requirement (W)
Jan	0	6.5	<0.5	7	0
Feb	6	6.5	<0.5	7	5
March	7	6.5	<0.5	7	6
April	9	6.5	<0.5	7	7
May	16	6.5	<0.5	7	13
June	41	6.5	<0.5	7	33
July	42	6.5	<0.5	7	33
Aug	32	6.5	<0.5	7	25
Sept	13	6.5	<0.5	7	10
Oct	0	6.5	<0.5	7	0
Nov	0	6.5	<0.5	7	0
Dec	0	6.5	<0.5	7	0
Total yearly water requirement <b>5060</b> m <sup>3</sup> /year					

Tabel D.2. Completed sheet on hydraulic power requirements, dry zone, Sri Lanka.



WIND POWER RESOURCES				
Location: <b>DRY ZONE</b> ..... Height above sea level: <b>4.30</b> ... m				
..... <b>SRI LANKA</b> .....				
Hub height: <b>12</b> ..... m Terrain roughness: <b>0.15</b> .....				
Combined correction factor for hub height and roughness: <b>1.05</b> .....				
Month	Average potential wind speed at 10 m (m/s)	Average wind speed at hub height (m/s)	Density of air (kg/m <sup>3</sup> )	Specific wind power (W/m <sup>2</sup> )
Jan	1.5	1.6	1.2	2
Feb	1.9	2.0	1.2	5
March	2.1	2.2	1.2	6
April	1.9	2.0	1.2	5
May	2.7	2.8	1.2	13
June	4.4	4.6	1.2	58
July	4.5	4.7	1.2	62
Aug	4.4	4.6	1.2	58
Sept	2.8	2.9	1.2	15
Oct	?	?	1.2	?
Nov	?	?	1.2	?
Dec	?	?	1.2	?

Table D.3. Completed sheet on wind power resources, dry zone, Sri Lanka

DESIGN MONTH					
Location: <b>DRY ZONE, SRI LANKA</b> .....					
Month	Average hydraulic power P <sub>hydr</sub> (W)	Average wind speed at hub height (m/s)	Specific wind power P <sub>wind</sub> (W/m <sup>2</sup> )	Reference area P <sub>hydr</sub> /P <sub>wind</sub> (m <sup>2</sup> )	Design month
Jan	0	1.6	2	0	
Feb	5	2.0	5	1.0	
March	6	2.2	6	1.0	
April	7	2.0	5	1.4	←
May	13	2.8	13	1.0	
June	33	4.6	58	0.6	
July	33	4.7	62	0.5	
Aug	25	4.6	58	0.4	
Sept	10	2.9	15	0.7	
Oct	0	?	?	0	
Nov	0	?	?	0	
Dec	0	?	?	0	

Table D.4. Completed sheet on identification of design month, dry zone, Sri Lanka.

WIND PUMP SYSTEM SIZING	
Location. <u>DRY ZONE</u> <u>SRI LANKA</u>	Height above sea level. <u>&lt; 30</u> m
Design month. <u>APRIL</u>	
Design month water requirements	
Pumping rate. <u>9</u>	m <sup>3</sup> /day
Pumping height. <u>7</u>	m
Hydraulic power requirement, P <sub>hydr</sub>	<u>7</u> W
Design month wind power resources	
Average wind speed. <u>2.0</u>	m/s
Air density (standard 1.2)	<u>1.2</u> kg/m <sup>3</sup>
Specific wind power P <sub>wind</sub>	<u>5</u> W/m <sup>2</sup>
Design month reference area P <sub>hydr</sub> /P <sub>wind</sub> <u>1.4</u> m <sup>2</sup>	
Type of wind pump	<input type="radio"/> Classical deepwell <input type="radio"/> Classical shallow well, balanced pump rod <input checked="" type="radio"/> Recent design, starting nozzle, balanced pump rod
Step	Calculations
1. Tower	Height. <u>12</u> m
2. Rotor	Energy production coefficient. <u>0.90</u> Maximum overall power coefficient. <u>0.18</u> Diameter. <u>7</u> m
3. Pump	Design wind speed. <u>2.5</u> m/s Design tip speed ratio. <u>7</u> Transmission ratio. <u>1.5</u> Stroke volume. <u>0.11</u> l Stroke. <u>100</u> mm Diameter. <u>100</u> mm
4. Storage tank	Volume. <u>12</u> m <sup>3</sup> Height. <u>1.5</u> m
5. Pipe work	Diameter. <u>80</u> mm Total length. <u>10</u> m

Table D.5. Completed sheet for wind pump system sizing, dry zone, Sri Lanka

WIND PUMP PERFORMANCE SPECIFICATION																																								
Location. <u>DRY ZONE</u> <u>SRI LANKA</u>	Height above sea level. <u>&lt; 30</u> m																																							
1. Water source																																								
Type. <u>OPEN WELL</u>	Distance (for surface pumping)..... m																																							
	Diameter (for wells)..... mm																																							
	Water level (when pumping)..... m																																							
2. Delivery system																																								
Type. <u>GALVANISED STEEL PIPES</u>	Length..... m																																							
	Pipe diameter..... mm																																							
	Efficiency..... %																																							
3. Storage system																																								
Type. <u>BACK WITH EARTH BUND</u>	Volume..... m <sup>3</sup>																																							
	Height..... m																																							
4. Design month details																																								
Month. <u>APRIL</u>	End use water requirement. <u>7</u> m <sup>3</sup> /day																																							
	Pumped water requirement. <u>9</u> m <sup>3</sup> /day																																							
	Hydraulic power requirement. <u>7</u> W																																							
	Average wind speed at hub height. <u>2.0</u> m/s																																							
5. Wind regime and water requirement																																								
	<table border="1"> <thead> <tr> <th></th> <th>Jan</th> <th>Feb</th> <th>Mar</th> <th>Apr</th> <th>May</th> <th>Jun</th> <th>Jul</th> <th>Aug</th> <th>Sep</th> <th>Oct</th> <th>Nov</th> <th>Dec</th> </tr> </thead> <tbody> <tr> <td>average wind speed at hub height (m/s)</td> <td>1.6</td> <td>2.0</td> <td>2.2</td> <td>2.0</td> <td>2.8</td> <td>4.6</td> <td>4.7</td> <td>4.6</td> <td>2.9</td> <td>?</td> <td>?</td> <td>?</td> </tr> <tr> <td>pumped water requirement (m<sup>3</sup> per day)</td> <td>0</td> <td>5</td> <td>6</td> <td>7</td> <td>13</td> <td>33</td> <td>33</td> <td>25</td> <td>10</td> <td>0</td> <td>0</td> <td>0</td> </tr> </tbody> </table>		Jan	Feb	Mar	Apr	May	Jun	Jul	Aug	Sep	Oct	Nov	Dec	average wind speed at hub height (m/s)	1.6	2.0	2.2	2.0	2.8	4.6	4.7	4.6	2.9	?	?	?	pumped water requirement (m <sup>3</sup> per day)	0	5	6	7	13	33	33	25	10	0	0	0
	Jan	Feb	Mar	Apr	May	Jun	Jul	Aug	Sep	Oct	Nov	Dec																												
average wind speed at hub height (m/s)	1.6	2.0	2.2	2.0	2.8	4.6	4.7	4.6	2.9	?	?	?																												
pumped water requirement (m <sup>3</sup> per day)	0	5	6	7	13	33	33	25	10	0	0	0																												
6. Windmill specification																																								
Tower height. <u>12</u>	m																																							
Machine type. <u>RECENT DESIGN</u>																																								
rotor diameter. <u>7</u>	m																																							
stroke. <u>100</u>	mm																																							
Pump type. <u>PISTON</u>																																								
cylinder diameter. <u>100</u>	mm																																							

Table D.6. Completed sheet for wind pump performance, dry zone, Sri Lanka

UNIT WATER COST FOR A SMALL-SCALE PUMPING SYSTEM	
System description Location..... DRY ZONE, SRI LANKA	
Design month..... APRIL	Design month pumping requirement..... 9 m <sup>3</sup> /day
Total head..... 7 m	Design month hydraulic power requirement..... 7 W
Annual water requirement..... 5060 m <sup>3</sup>	
Power source..... WIND PUMP	Size..... 3 m DIAMETER
Storage tank size..... 2.5 m <sup>3</sup>	
Economic information	
Interest rate.....	Real interest rate..... 12.5%
Inflation rate.....	
Costs	
System component 1: WIND PUMP	
Investment..... \$ 700	
Lifetime..... 10 years	
Annuity..... 0.18	
Average annual capital cost.....	\$ 126
Average annual cost of maintenance and repair.....	\$ 35
System component 2: WELL, STORAGE TANK	
Investment..... \$ 350	
Lifetime..... 10 years	
Annuity..... 0.18	
Average annual capital cost.....	\$ 63
Average annual cost of maintenance and repair.....	\$ 7
Annual cost of operation of the system.....	0
Total annual costs	\$ 231
Unit water costs	\$cents/m <sup>3</sup> 4.6

Table D.7. Completed sheet of unit water costs for a wind pump, dry zone, Sri Lanka

UNIT WATER COST FOR A SMALL-SCALE PUMPING SYSTEM	
System description Location..... DRY ZONE, SRI LANKA	
Design month..... JULY	Design month pumping requirement..... 9 m <sup>3</sup> /day
Total head..... 7 m	Design month hydraulic power requirement..... 7 W
Annual water requirement..... 5060 m <sup>3</sup>	
Power source..... KEROSENE PUMP	Size..... 1.4 kW
Storage tank size..... ~ m <sup>3</sup>	
Economic information	
Interest rate.....	Real interest rate..... 12.5%
Inflation rate.....	
Costs	
System component 1: KEROSENE PUMP	
Investment..... \$ 230	
Lifetime..... 9 years	
Annuity..... 0.19	
Average annual capital cost.....	\$ 44
Average annual cost of maintenance and repair.....	\$ 26
System component 2: WELL	
Investment..... \$ 130	
Lifetime..... 10 years	
Annuity..... 0.18	
Average annual capital cost.....	\$ 23
Average annual cost of maintenance and repair.....	~
Annual cost of operation of the system.....	\$ 211
Total annual costs	\$ 304
Unit water costs	\$cents/m <sup>3</sup> 6.0

Table D.8. Completed sheet of unit water costs for a kerosene pump, dry zone, Sri Lanka

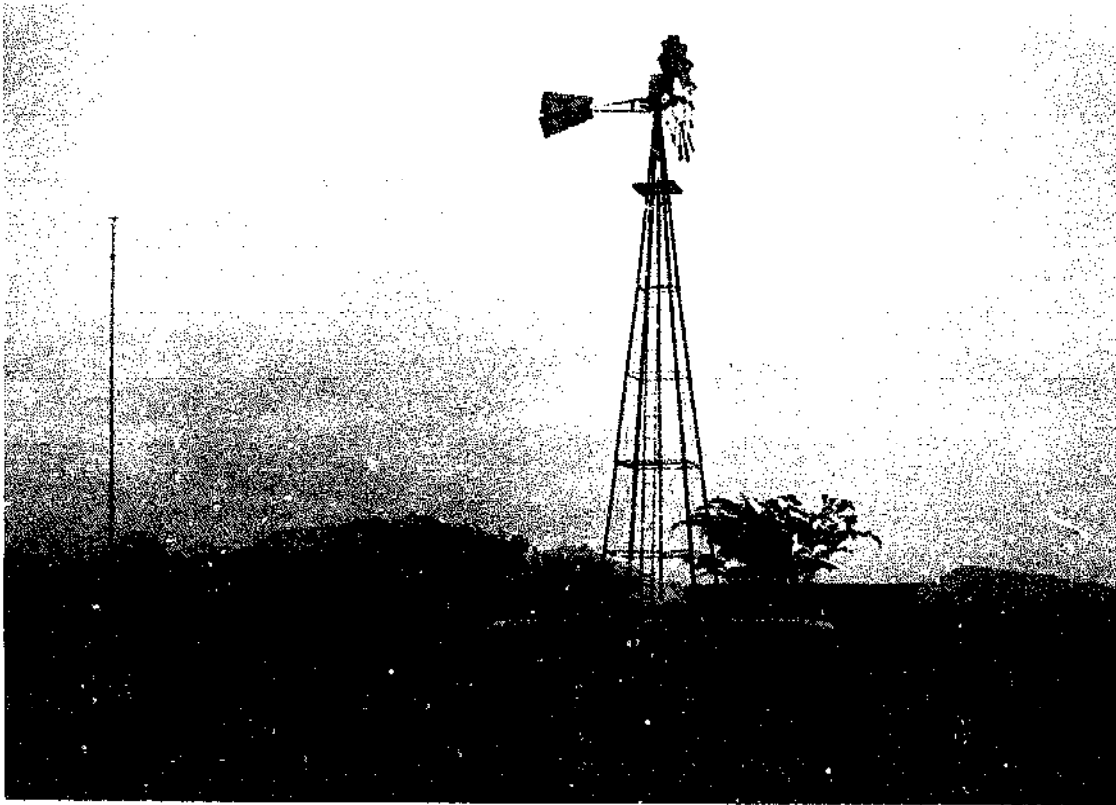

*Dempster 8' windmill operating at Achade Sao Filipe in 1982. At the time of installation Achade Sao Filipe was a desert.*

## Example D.2. Water supply to the village of Sao Filipe, Cape Verde

This example describes one of the wind pump installations integrated in a larger wind pump water supply system at Achada Sao Filipe, Cape Verde. The information presented here was derived mainly from references 23 and 24.

Figures D.2 and D.3 (both from reference 24) give an overview of the complete water supply system.

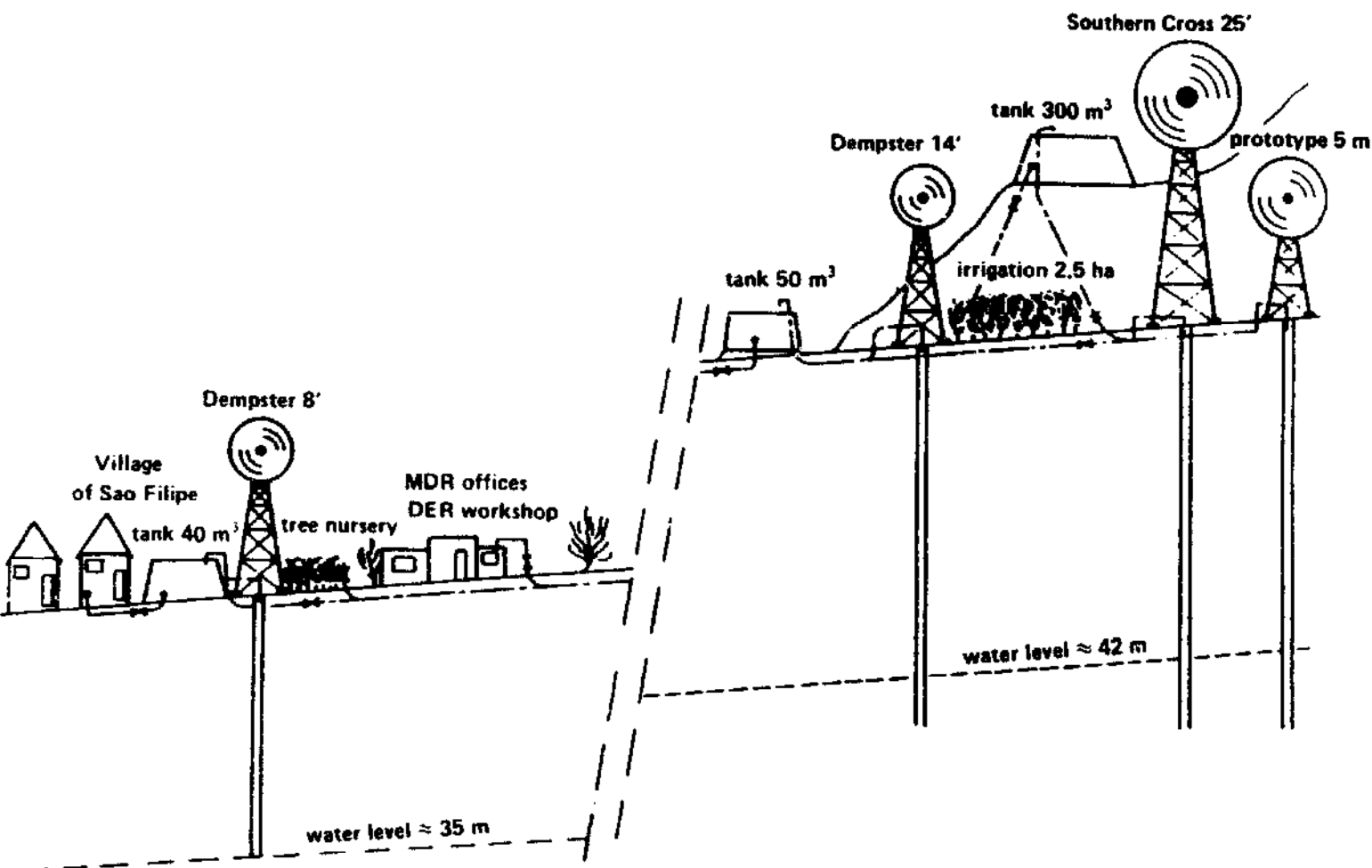

Figure D.2. Layout of Achada Sao Filipe water supply system (cross section), reference 24.

The example concerns the wind pump closest to the village of Sao Filipe, in the figure indicated by "Dempster 8' ". It is representative for windmill installations on Achadas ("plains"), characterized by deep water levels and very high wind speeds.

Two alternative pumping options will be considered:

- a. a classical windmill
- b. a diesel motor driving a deep well turbine pump, through a belt and vertical shaft.

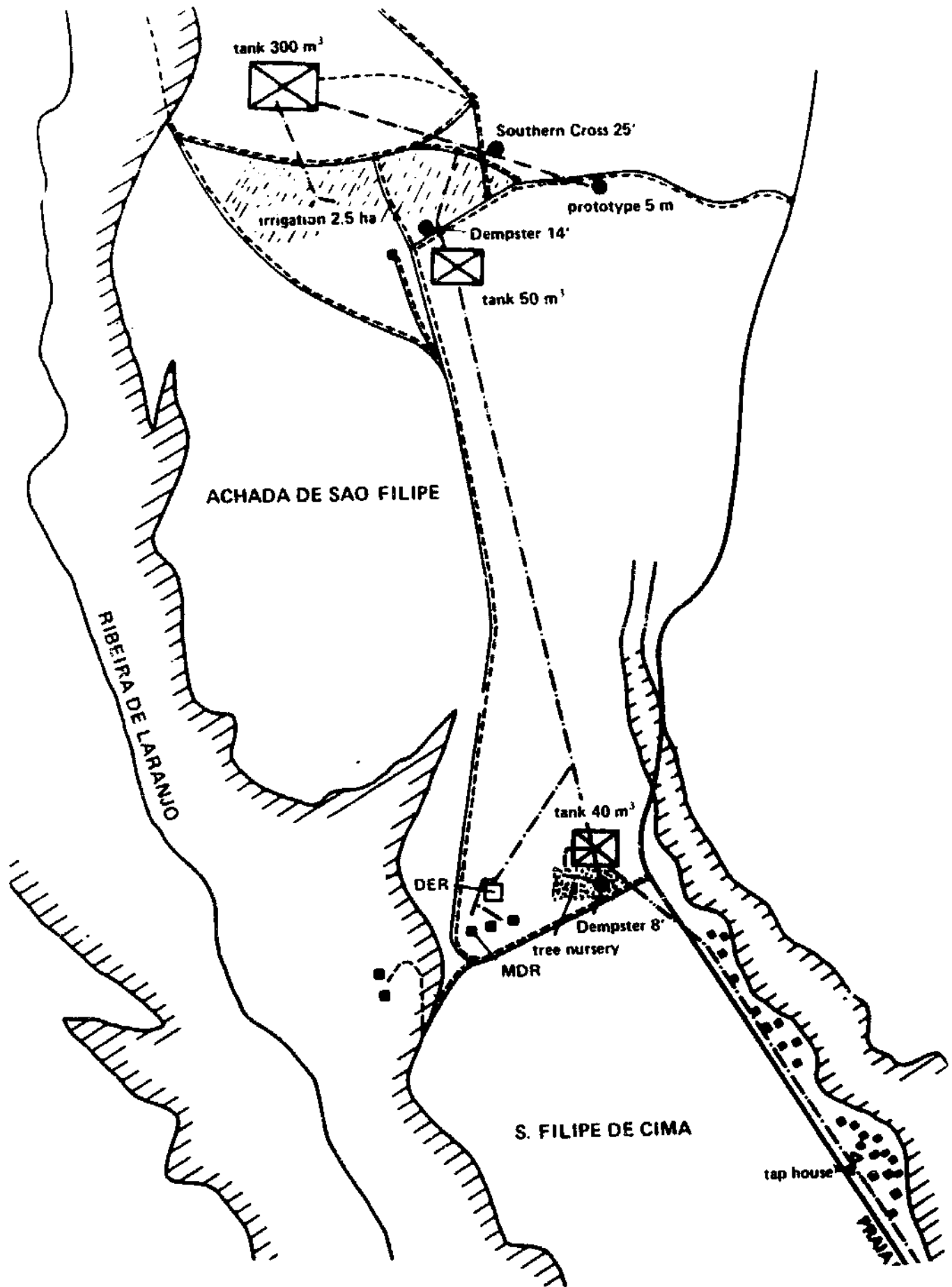

Figure D.3. Layout of Achade Sao Filipe water pumping system

The following technical and economic information is to be used:

Water needs (for the complete interconnected system):

Domestic water supply for 500 persons in Sao Filipe (12.5 m<sup>3</sup>/day). Livestock watering: unknown, highly variable number of cattle and goats.  
Tree nursery of reforestation project (5 m<sup>3</sup>/day during 5 months of the year).  
Offices and workshop (approximately 100 persons).  
Water for civil works, taken by tank trucks, or in drums.  
Irrigation (2.5 ha, approximately 100 m<sup>3</sup>/day)

Well closest to the village of Sao Filipe:

Tubewell: internal diameter 150 mm.  
Depth: 75 m  
Static water level: 35 m below ground level  
Dynamic water level for a pumping rate of 0.5 l/s: 37 m

Water distribution: Galvanized steel pipes.

Usual type of tank: Heavy masonry, covered with concrete slab in case of drinking water; height above ground level: about 2.5 m.

Wind regime: Long term data are available from Praia airport, a few kilometers from Sao Filipe, situated on an Achada, very well exposed to the wind.  
By means of short term measurements at Achada Sao Filipe, correlations have been established (see reference 24). The results are summarized in Table D.9 below.

Terrain, landscape: Achadas (gently sloping plains), intersected by Ribeiras (deep valleys).  
Achada Sao Filipe: covered by bushes and low trees.  
Praia airport: flat, covered by stones, hardly any vegetation.

Pumping options: Wind pump, or a diesel engine driving deep well turbine pump

Cost of windmill: Type: classical multiblade windmill, back geared ( $i=0.3$ ), manufactured in the USA, 8' diameter, or 2.4 m.  
Purchase and transport: 133,000 \$CV, US \$ 1750\*  
Installation: 26,000 \$CV US \$ 350  
Lifetime: 15 years  
Maintenance: 12,000 \$CV/year, US \$ 160/year

Cost of storage tank: Type: heavy masonry with concrete slab cover, capacity 40 m<sup>3</sup>  
Investment: 275,000 \$CV US \$ 3620  
Lifetime: 30 years  
Maintenance: virtually zero

Cost of engine pump:	Type: Not exactly indicated in the references, approximately as follows:	
	Diesel engine of 5 kW, fuel consumption 2 l/hr (25% efficiency).	
	Multistage turbine deep well pump, nominal rating:	
	- output 14 m <sup>3</sup> /hr at 40 m head	
	- mechanical power demand: 2.5 kW	
	- efficiency 60%	
	Investment: 136,400 \$CV	US \$ 1800
Installation: 20,000 \$CV	US \$ 260	
Lifetime: 10,000 operating hours		
Maintenance: 10% of investment per 1,000 operating hours		
Diesel fuel: 20 \$CV/l	US \$ 0.26/l	
Tubewell:	Investment: 13,000 \$CV/m	US \$ 170/m
	Lifetime: 30 years	
	Maintenance: virtually zero	
Cost of operator:	Annual salary: 36,000 \$CV	US \$ 470

\* All costs indicated here are for end 1983, (1 US\$ = 75 \$CV).

Month	J	F	M	A	M	J	J	A	S	O	N	D	year
Measured wind speed (m/s) at 7.5 m	7.2	7.9	7.8	7.4	8.0	6.7	5.2	4.8	5.1	6.4	6.4	7.1	6.7
Calculated wind speed (m/s) at 10 m	7.6	8.3	8.2	7.8	8.4	7.0	5.5	5.1	5.4	6.7	6.7	7.5	7.0

Table D.9. Wind speed data of Praia airport (reference 24) measured at 7.5 m height, converted to standard 10 m height, assuming a terrain roughness  $s_0$  of 0.03 m.

The procedures for sizing and cost estimation of the wind pump have been carried out by filling in the format sheets as indicated in Chapters 3 and 5. The completed format sheets are shown on the following pages, Tables D.10 to D.16.

### Hydraulic power requirements

In this particular case the hydraulic power requirements are not determined by the need for water. As indicated above, water is needed for a variety of purposes, and the need exceeds the availability of water in this arid region.

The pumping requirement is rather determined by the capacity of the well: Since the well is very expensive, it should be exploited to its full capacity, but care should be taken not to over-exploit it.



In this particular case a pumping rate of 0.5 l/s seemed acceptable, leading to the values indicated in Table D.10.

The head loss in the delivery pipe is very low, since quite a large size is required in order to minimize shock forces in the pump rod.

### **Wind power resources**

The long term data for Praia airport (see Table D.9) were measured at 7.5 m height. The terrain roughness of Praia airport is approximately 0.03 m. Using this roughness the data were converted to 10 m height.

Since the roughness of the terrain around the airport is approximately equal to the standard roughness of 0.03 m, the second line of Table D.9 directly indicates the potential wind speed at Praia airport.

Achada Sao Filipe, at a distance of a few kilometers, will have the same potential wind speed (see first column of format sheet in Table D.11). The roughness of the terrain at Achada Sao Filipe is approximately 0.50 m. Using the methods described in annex A the sheet is completed to find the wind speed at hub height.

Comparing the results with the original data of the airport yields a ratio of 0.89, in reasonable agreement with the ratio of 0.85 found from short term measurements.

The site is close to sea level, therefore the density of the air is taken to be 1.2 kg/m<sup>3</sup>.

Subsequently the specific wind power is calculated.

### **Identification of design month**

The data of the previous format sheets are filled in in the sheet for design month identification, Table D.12. The ratio of hydraulic power to specific wind power is calculated to give the reference area.

In this particular case, in which the system is not designed to meet a demand but to avoid over-exploitation of the well, the design month is the month having the lowest reference area, i.e. May.

For this month a reference area of 0.8 m<sup>2</sup> is found. From Table D.12 one sees that a wind pump designed on this basis is large enough to exploit the well at close to the desired capacity throughout the year, except for the months of July, August and September, for which a reference area of around 3 m<sup>2</sup> would be required.

### **Wind pump system sizing**

The five steps indicated in the format sheet for wind pump sizing must be carried out (see table D.13).

A standard tower height of 12 m is chosen.

From Table 2.2, Chapter 2 one finds a value for the energy production coefficient of 0.40, and for the peak overall power coefficient of 0.30.

Using the nomogram in Figure 3.3, Chapter 3, one finds a rotor diameter of 2.9 m. For practical purposes one chooses the closest size in the standard range, i.e. 8 ft or 2.44 m.

From Table 2.2, Chapter 2 one finds a value for  $V_d/V$  of 0.6. With the average wind speed in the design month of 7.3 m/s, one would find a design wind speed of 4.4 m/s. However, the type of wind pump is structurally not strong enough to allow a higher design wind speed than approximately 3 m/s. Using the nomogram of Figure 3.4, Chapter 3, one finds a stroke volume of 0.55 liters.

This may be realized with a pump of  $2\frac{1}{4}$ " diameter (63.5 mm) and a stroke of  $7\frac{1}{2}$ " (191 mm), giving a stroke volume of 0.60 l.

A storage tank of 40 m<sup>3</sup> is chosen, corresponding to 2 days of consumption for the village and some consumption for livestock. The relatively large size of the tank is justified, since water is a vital resource in this dry region.

The diameter of the pipes is chosen to be 2". This was found to be a minimum in order to reduce shock forces in the pump rod, and avoid breaking of pump rods.

Note that the relatively low value chosen for  $V_d$  leads to a lower output than aimed at originally. For calculating the actual output, one must use the output prediction method of Appendix B.2. This will be needed in the financial analysis.

### **Wind pump performance specification**

Using the information obtained above, the specification sheet can be completed in a straightforward way.

### **Unit water cost for a wind pumping system**

First the annual water output must be established. It is assumed that all water pumped will be put to some use. Therefore one should calculate the total volume of water pumped by the windmill. This may be done using the graph in Figure B.1.

The annual average wind speed can be calculated from the sheet in Table D.11 to be 6.1 m/s. Now, one finds a ratio of design over average wind speed of 0.49, an energy production coefficient of 0.35 and an average power production of 67 W, corresponding to 5400 m<sup>3</sup> per year (which is close to what has been measured in practice, reference 24).

For the interest rate a value of 10% is taken.

For the rest, the sheet in Table D.15 may be completed in a straightforward way.

The extremely high costs of storage tank and tubewell, US \$ 16,370, are to be noted. The well is particularly expensive: US \$ 12,750!

The result is a water cost of US \$ 0.50/m<sup>3</sup>.

### **Unit water cost using a diesel pump**

Subsequently the cost of the alternative, using an engine-driven pump is examined by filling in the data sheet for unit water costs of a diesel pump (Figure D.16).

In this particular case the size is dictated by the capacity of the well, 0.5 l/s (see above). Normally diesel pumps are operated for 4, 6, or 8 hours per day. However, in order to pump as much water as possible it will be assumed that the pump is used for 10 hours per day, leading to the indicated monthly and annual pumping rates.

For this purpose the smallest available diesel pump set may be used (see specifications above). In order to reduce the pumping rate a regulating valve will be used on the outlet of the pump and adjusted in a way as to give a pumping rate of 0.5 l/s. Doing this the power demand of the pump will slightly decrease, the diesel motor is not fully loaded, and the fuel consumption will decrease somewhat, assume approximately 1.5 l/hr. As a result the efficiency of the engine pump is very low (less than 2%).

Operating the diesel pump for 10 hours per day leads to a lifetime (10,000 hours) of 3 years. Now, the format sheet may be completed further. The cost of operation includes an operator and the fuel costs.

A unit water cost of 80 \$cts/m<sup>3</sup> is found, considerably higher than for the windmill.

In this particular case the use of a wind pump is far more attractive than a diesel pump. This is partly due to the high wind speeds at the site, but also to the low capacity of the well; even the smallest size of diesel pump is under-utilized on this well.

HYDRAULIC POWER REQUIREMENTS					
Location <b>ACHADA . SAO . FILIPE , CAPE . VERDE</b> .....					
Delivery pipe head loss... <b>1</b> ...%			Delivery pipe length <b>42+20</b> ..m		
Month	Pumping requirement (m <sup>3</sup> /day)	Pumping height (m)	Head loss (m)	Total head (m)	Average hydraulic power requirement (W)
Jan	<b>43</b>	<b>39.5</b>	<b>&lt;0.5</b>	<b>40</b>	<b>195</b>
Feb	<b>43</b>	<b>39.5</b>	<b>&lt;0.5</b>	<b>40</b>	<b>195</b>
March	<b>43</b>	<b>39.5</b>	<b>&lt;0.5</b>	<b>40</b>	<b>195</b>
April	<b>43</b>	<b>39.5</b>	<b>&lt;0.5</b>	<b>40</b>	<b>195</b>
May	<b>43</b>	<b>39.5</b>	<b>&lt;0.5</b>	<b>40</b>	<b>195</b>
June	<b>43</b>	<b>39.5</b>	<b>&lt;0.5</b>	<b>40</b>	<b>195</b>
July	<b>43</b>	<b>39.5</b>	<b>&lt;0.5</b>	<b>40</b>	<b>195</b>
Aug	<b>43</b>	<b>39.5</b>	<b>&lt;0.5</b>	<b>40</b>	<b>195</b>
Sept	<b>43</b>	<b>39.5</b>	<b>&lt;0.5</b>	<b>40</b>	<b>195</b>
Oct	<b>43</b>	<b>39.5</b>	<b>&lt;0.5</b>	<b>40</b>	<b>195</b>
Nov	<b>43</b>	<b>39.5</b>	<b>&lt;0.5</b>	<b>40</b>	<b>195</b>
Dec	<b>43</b>	<b>39.5</b>	<b>&lt;0.5</b>	<b>40</b>	<b>195</b>
Total yearly water requirement <b>15,700</b> m <sup>3</sup> /year					

Table D.10. Format sheet for assessment of hydraulic power requirements.

WIND POWER RESOURCES				
Location: <i>ACHADA SAO FILIPE</i> ..... Height above sea level: <i>200</i> m ..... <i>CAPE VERDE</i> .....				
Hub height: <i>12</i> ..... m Terrain roughness: <i>0.50</i> .....				
Combined correction factor for hub height and roughness: <i>0.89</i> .....				
Month	Average potential wind speed at 10 m (m/s)	Average wind speed at hub height (m/s)	Density of air (kg/m <sup>3</sup> )	Specific wind power (W/m <sup>2</sup> )
Jan	<i>7.6</i>	<i>6.6</i>	<i>1.2</i>	<i>172</i>
Feb	<i>8.3</i>	<i>7.2</i>	<i>1.2</i>	<i>224</i>
March	<i>8.2</i>	<i>7.1</i>	<i>1.2</i>	<i>215</i>
April	<i>7.8</i>	<i>6.8</i>	<i>1.2</i>	<i>189</i>
May	<i>8.4</i>	<i>7.3</i>	<i>1.2</i>	<i>233</i>
June	<i>7.0</i>	<i>6.0</i>	<i>1.2</i>	<i>130</i>
July	<i>5.5</i>	<i>4.8</i>	<i>1.2</i>	<i>66</i>
Aug	<i>5.1</i>	<i>4.6</i>	<i>1.2</i>	<i>58</i>
Sept	<i>5.4</i>	<i>4.7</i>	<i>1.2</i>	<i>62</i>
Oct	<i>6.7</i>	<i>5.8</i>	<i>1.2</i>	<i>117</i>
Nov	<i>6.7</i>	<i>5.8</i>	<i>1.2</i>	<i>117</i>
Dec	<i>7.5</i>	<i>6.6</i>	<i>1.2</i>	<i>172</i>

Table D.11. Completed sheet on wind power resources, Achada Sao Filipe, Cape Verde

DESIGN MONTH					
Location: <i>ACHADA SAO FILIPE, CAPE VERDE</i> .....					
Month	Average hydraulic power $P_{hydr}$ (W)	Average wind speed at hub height (m/s)	Specific wind power $P_{wind}$ (W/m <sup>2</sup> )	Reference area $P_{hydr}/P_{wind}$ (m <sup>2</sup> )	Design month
Jan	<i>195</i>	<i>6.6</i>	<i>172</i>	<i>1.1</i>	
Feb	<i>195</i>	<i>7.2</i>	<i>224</i>	<i>0.9</i>	
March	<i>195</i>	<i>7.1</i>	<i>215</i>	<i>0.9</i>	
April	<i>195</i>	<i>6.8</i>	<i>189</i>	<i>1.0</i>	
May	<i>195</i>	<i>7.3</i>	<i>233</i>	<i>0.8</i>	←
June	<i>195</i>	<i>6.0</i>	<i>130</i>	<i>1.5</i>	
July	<i>195</i>	<i>4.8</i>	<i>66</i>	<i>3.0</i>	
Aug	<i>195</i>	<i>4.6</i>	<i>58</i>	<i>3.4</i>	
Sept	<i>195</i>	<i>4.7</i>	<i>62</i>	<i>3.1</i>	
Oct	<i>195</i>	<i>5.8</i>	<i>117</i>	<i>1.7</i>	
Nov	<i>195</i>	<i>5.8</i>	<i>117</i>	<i>1.7</i>	
Dec	<i>195</i>	<i>6.6</i>	<i>172</i>	<i>1.1</i>	

Table D.12. Completed sheet for identification of design month, Achada Sao Filipe, Cape Verde.

WIND PUMP SYSTEM SIZING	
Location <i>ACHADA SAO FILIPE</i> ..... Height above sea level <i>&lt; 100</i> ...m <i>CAPE VERDE</i> .....	
Design month <i>MAY</i> .....	
Design month water requirements	
Pumping rate.....	<i>43</i> .....m <sup>3</sup> /day
Pumping height.....	<i>40</i> .....m
Hydraulic power requirement, P <sub>hydr</sub> .....	<i>195</i> .....W
Design month wind power resources	
Average wind speed.....	<i>7.3</i> .....m/s
Air density (standard 1.2).....	<i>1.2</i> .....kg/m <sup>3</sup>
Specific wind power P <sub>wind</sub> .....	<i>233</i> .....W/m <sup>2</sup>
Design month reference area P <sub>hydr</sub> /P <sub>wind</sub> .....	<i>0.8</i> .....m <sup>2</sup>
Type of wind pump <input checked="" type="checkbox"/> Classical deepwell <input type="checkbox"/> Classical shallow well, balanced pump rod <input type="checkbox"/> Recent design, starting nozzle, balanced pump rod	
Step	Calculations
1. Tower	Height..... <i>12</i> .....m
2. Rotor	Energy production coefficient..... <i>0.40</i> Maximum overall power coefficient..... <i>0.30</i> Diameter..... <i>2.44</i> .....m
3. Pump	Design wind speed..... <i>3</i> .....m/s Design tip speed ratio..... <i>1</i> Transmission ratio..... <i>0.3</i> Stroke volume..... <i>0.85</i> .....l Stroke..... <i>1 1/4 = 1.25</i> .....mm Diameter..... <i>1 1/2 = 1.5</i> .....mm
4. Storage tank	Volume..... <i>40</i> .....m <sup>3</sup> Height..... <i>4.8</i> .....m
5. Pipe work	Diameter..... <i>2" = 50</i> .....mm Total length..... <i>64</i> .....m

Table D.13. Completed sheet for wind pump system sizing, Achada Sao Filipe, Cape Verde

WIND PUMP PERFORMANCE SPECIFICATION	
Location <i>ACHADA SAO FILIPE</i> ..... Height above sea level <i>&lt; 100</i> .....m <i>CAPE VERDE</i> .....	
1. Water source	Type <i>TUBEWELL</i> ..... Distance (for surface pumping).....m Diameter (for wells)..... <i>40</i> .....mm Water level (when pumping)..... <i>38.5</i> .....m
2. Delivery system	Type <i>GALVANIZED STEEL PIPES</i> ..... Length <i>40 M WELL + 20</i> .....m Pipe diameter..... <i>2" = 50</i> .....mm Efficiency..... <i>700</i> .....%
3. Storage system	Type <i>MASONRY TANK</i> ..... Volume..... <i>40</i> .....m <sup>3</sup> Height..... <i>4.8</i> .....m
4. Design month details	Month..... <i>MAY</i> ..... End use water requirement..... <i>7</i> .....m <sup>3</sup> /day Pumped water requirement..... <i>43</i> .....m <sup>3</sup> /day Hydraulic power requirement..... <i>195</i> .....W Average wind speed at hub height..... <i>7.3</i> .....m/s
5. Wind regime and water requirement	
	Jan Feb Mar Apr May Jun Jul Aug Sep Oct Nov Dec
average wind speed at hub height (m/s)	<i>6.6 7.2 7.1 6.8 7.3 6.0 4.8 4.6 4.7 5.8 5.8 6.6</i>
pumped water requirement (m <sup>3</sup> per day)	<i>&lt;43 &lt;43 &lt;43 &lt;43 &lt;43 &lt;43 &lt;43 &lt;43 &lt;43 &lt;43 &lt;43 &lt;43</i>
6. Windmill specification	Tower height..... <i>12</i> .....m Machine type <i>CLASSICAL MULTIBLADE</i> ..... rotor diameter..... <i>2" = 2.44</i> .....m stroke..... <i>1 1/4 = 1.25</i> .....mm Pump type..... <i>DEEPWELL</i> ..... cylinder diameter..... <i>1 1/2 = 1.5</i> .....mm

Table D.14. Completed sheet for wind pump performance specification, Achada Sao Filipe, Cape Verde

UNIT WATER COST FOR A SMALL-SCALE PUMPING SYSTEM	
System description	
Location..... <i>ACHADA SAO FILIPE, CAPE VERDE</i>	
Design month..... <i>MAY</i>	Design month pumping requirement..... <i>43</i> ..... m <sup>3</sup> /day
Total head..... <i>40</i> ..... m	Design month hydraulic power requirement..... <i>195</i> ..... W
Annual water requirement..... <i>5400</i> ..... m <sup>3</sup>	
Power source..... <i>WIND PUMP</i>	Size..... <i>2.44 m DIA PUMP</i>
Storage tank size..... <i>40</i> ..... m <sup>3</sup>	
Economic information	
Interest rate.....	Real interest rate..... <i>10%</i>
Inflation rate.....	
Costs	
System component 1: <i>WIND PUMP</i>	
Investment.....	<i>\$ 2100</i>
Lifetime.....	<i>15</i> ..... years
Annuity.....	<i>0.13</i>
Average annual capital cost.....	<i>\$ 270</i>
Average annual cost of maintenance and repair.....	<i>\$ 160</i>
System component 2: <i>WELL AND STORAGE TANK</i>	
Investment.....	<i>\$ 16,370</i>
Lifetime.....	<i>30</i> ..... years
Annuity.....	<i>0.11</i>
Average annual capital cost.....	<i>\$ 1800</i>
Average annual cost of maintenance and repair.....	<i>~</i>
Annual cost of operation of the system.....	<i>\$ 470</i>
Total annual costs	<i>\$ 2700</i>
Unit water costs	<i>US \$CENTS/m<sup>3</sup> 50</i>

Table D.15. Completed sheet on water cost for a wind pump, Achada Sao Filipe, Cape Verde

UNIT WATER COST FOR A SMALL-SCALE PUMPING SYSTEM	
System description	
Location..... <i>ACHADA SAO FILIPE, CAPE VERDE</i>	
Design month..... <i>7</i>	Design month pumping requirement..... <i>18</i> ..... m <sup>3</sup> /day
Total head..... <i>40</i> ..... m	Design month hydraulic power requirement..... <i>82</i> ..... W
Annual water requirement..... <i>6600</i> ..... m <sup>3</sup>	
Power source..... <i>DIESEL ENGINE</i>	Size..... <i>5 kW</i>
Storage tank size..... m <sup>3</sup>	
Economic information	
Interest rate.....	Real interest rate..... <i>10%</i>
Inflation rate.....	
Costs	
System component 1: <i>DIESEL PUMP SET</i>	
Investment.....	<i>\$ 2060</i>
Lifetime.....	<i>3</i> ..... years
Annuity.....	<i>0.40</i>
Average annual capital cost.....	<i>\$ 824</i>
Average annual cost of maintenance and repair.....	<i>\$ 752</i>
System component 2: <i>WELL AND STORAGE TANK</i>	
Investment.....	<i>\$ 16,370</i>
Lifetime.....	<i>30</i> ..... years
Annuity.....	<i>0.11</i>
Average annual capital cost.....	<i>\$ 1800</i>
Average annual cost of maintenance and repair.....	<i>~</i>
Annual cost of operation of the system.....	<i>\$ 1894</i>
Total annual costs	<i>\$ 5270</i>
Unit water costs	<i>US \$CENTS/m<sup>3</sup> 80</i>

Table D.16. Completed sheet on water cost of a diesel pump, Achada Sao Filipe, Cape Verde

## Appendix E BLANK FORMAT SHEETS



*A wind pump made using village technology at Miramar, Peru.*



## Appendix E

# BLANK FORMAT SHEETS

### Contents

- Format sheet for assessment of hydraulic power requirements (page E-2).
- Format sheet for assessment of wind power resources (page E-3).
- Format sheet for identification of design month (page E-4).
- Format sheet for wind pump system sizing (page E-5).
- Format sheet for specification of wind pump performance (page E-6).
- Format sheet to calculate the unit water cost of a small-scale pumping system (page E-7).
- Format sheet for determining Weibull parameters of wind speed distribution (page E-8).
- Format sheet for generalized cost comparison (page E-9).

HYDRAULIC POWER REQUIREMENTS					
Location.....					
Delivery pipe head loss..... $\frac{m}{m^3}$			Delivery pipe length.....m		
Month	Pumping requirement ( $m^3/day$ )	Pumping height (m)	Head loss (m)	Total head (m)	Average hydraulic power requirement (W)
Jan					
Feb					
March					
April					
May					
June					
July					
Aug					
Sept					
Oct					
Nov					
Dec					
Total yearly water requirement				$m^3/year$	

Format sheet for assessment of hydraulic power requirements.

WIND POWER RESOURCES				
Location.....Height above sea level.....m .....				
Hub height.....m Terrain roughness.....				
Combined correction factor for hub height and roughness.....				
Month	Average potential wind speed at 10 m (m/s)	Average wind speed at hub height (m/s)	Density of air (kg/m <sup>3</sup> )	Specific wind power (W/m <sup>2</sup> )
Jan				
Feb				
March				
April				
May				
June				
July				
Aug				
Sept				
Oct				
Nov				
Dec				

Format sheet for assessment of wind power resources.

DESIGN MONTH					
Location:.....					
Month	Average hydraulic power $P_{hydr}$ (W)	Average wind speed at hub height (m/s)	Specific wind power $P_{wind}$ (W/m <sup>2</sup> )	Reference area $P_{hydr}/P_{wind}$ (m <sup>2</sup> )	Design month
Jan					
Feb					
March					
April					
May					
June					
July					
Aug					
Sept					
Oct					
Nov					
Dec					

Format sheet for identification of design month.

<b>WIND PUMP SYSTEM SIZING</b>	
Location... ..	Height above sea level.....m
Design month.....	
<b>Design month water requirements</b>	
Pumping rate.....	m <sup>3</sup> /day
Pumping height.....	m
Hydraulic power requirement, $\dot{P}_{hydr}$ .....	W
<b>Design month wind power resources</b>	
Average wind speed.....	m/s
Air density (standard 1.2).....	kg/m <sup>3</sup>
Specific wind power $P_{wind}$ .....	W/m <sup>2</sup>
Design month reference area $\dot{P}_{hydr}/P_{wind}$ .....	
Type of wind pump   o Classical deepwell o Classical shallow well, balanced pump rod o Recent design, starting nozzle, balanced pump rod	
Step	Calculations
1. Tower	Height.....m
2. Rotor	Energy production coefficient..... Maximum overall power coefficient..... Diameter.....m
3. Pump	Design wind speed.....m/s Design tip speed ratio..... Transmission ratio..... Stroke volume.....l Stroke.....mm Diameter.....mm
4. Storage tank	Volume.....m <sup>3</sup> Height.....m
5. Pipe work	Diameter.....mm Total length.....m

<b>WIND PUMP PERFORMANCE SPECIFICATION</b>												
Location.....Height above sea level.....m .....												
1. Water source			Type..... Distance (for surface pumping).....m Diameter (for wells).....mm Water level (when pumping).....m									
2. Delivery system			Type..... Length.....m Pipe diameter.....mm Efficiency.....%									
3. Storage system			Type..... Volume.....m <sup>3</sup> Height.....m									
4. Design month details			Month..... End use water requirement.....m <sup>3</sup> /day Pumped water requirement.....m <sup>3</sup> /day Hydraulic power requirement.....W Average wind speed at hub height.....m/s									
5. Wind regime and water requirement												
	Jan	Feb	Mar	Apr	May	Jun	Jul	Aug	Sep	Oct	Nov	Dec
average wind speed at hub height (m/s)												
pumped water requirement (m <sup>3</sup> per day)												
6. Windmill specification			Tower height.....m Machine type..... rotor diameter.....m stroke.....mm Pump type..... cylinder diameter.....mm									

<b>UNIT WATER COST FOR A SMALL-SCALE PUMPING SYSTEM</b>	
<b>System description</b>	
Location.....	
Design month.....	Design month pumping requirement.....m <sup>3</sup> /day
Total head.....m	Design month hydraulic power requirement.....W
Annual water requirement.....m <sup>3</sup>	
Power source.....	Size.....
Storage tank size.....m <sup>3</sup>	
<b>Economic information</b>	
Interest rate.....	Real interest rate.....
Inflation rate.....	
<b>Costs</b>	
<b>System component 1:</b> .....	
Investment.....	
Lifetime.....years	
Annuity.....	
Average annual capital cost.....	
Average annual cost of maintenance and repair.....	
<b>System component 2:</b> .....	
Investment.....	
Lifetime.....years	
Annuity.....	
Average annual capital cost.....	
Average annual cost of maintenance and repair.....	
Annual cost of operation of the system.....	
<b>Total annual costs</b>	
<b>Unit water costs</b>	

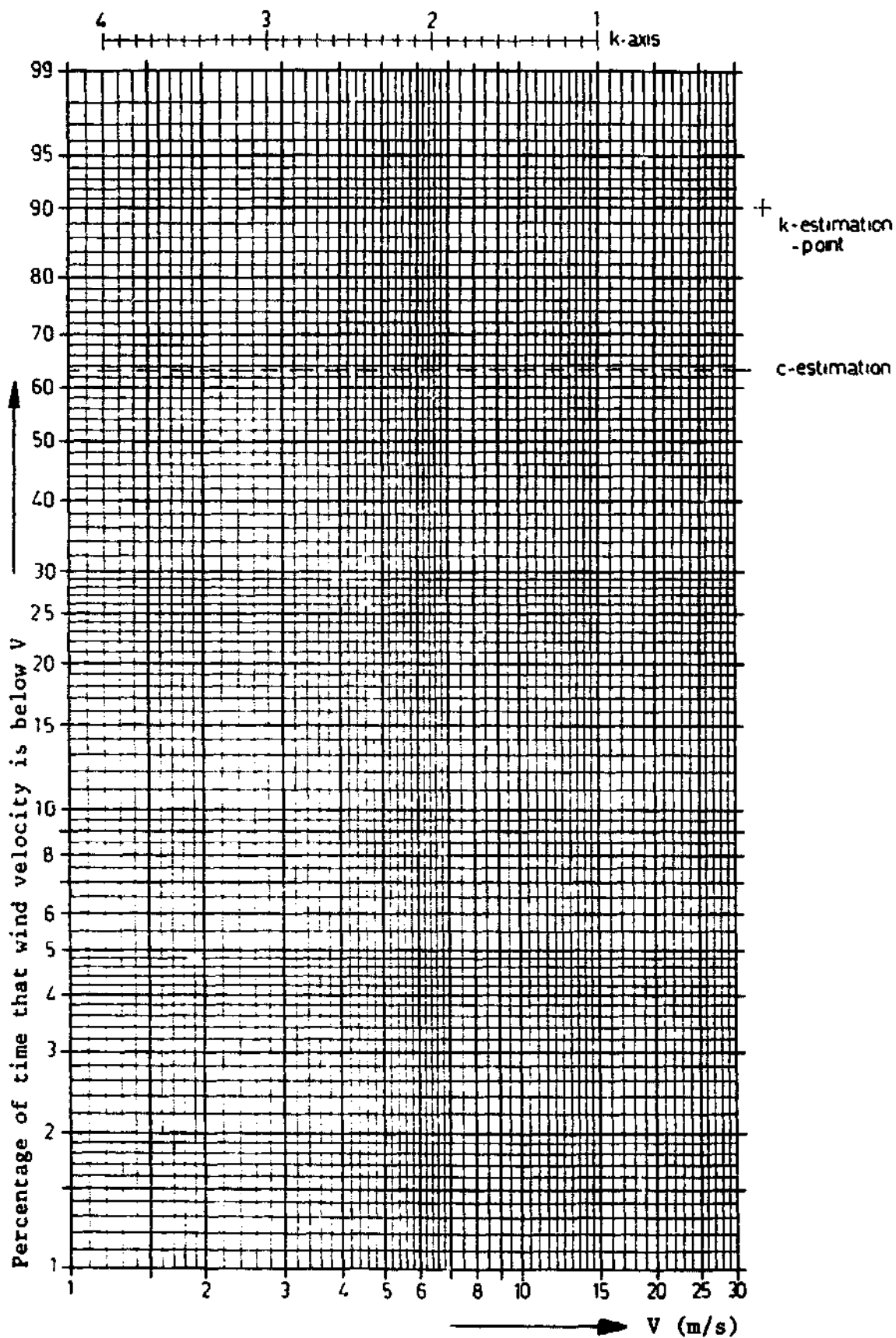

Format sheet for determining Weibull parameters of wind speed distribution.



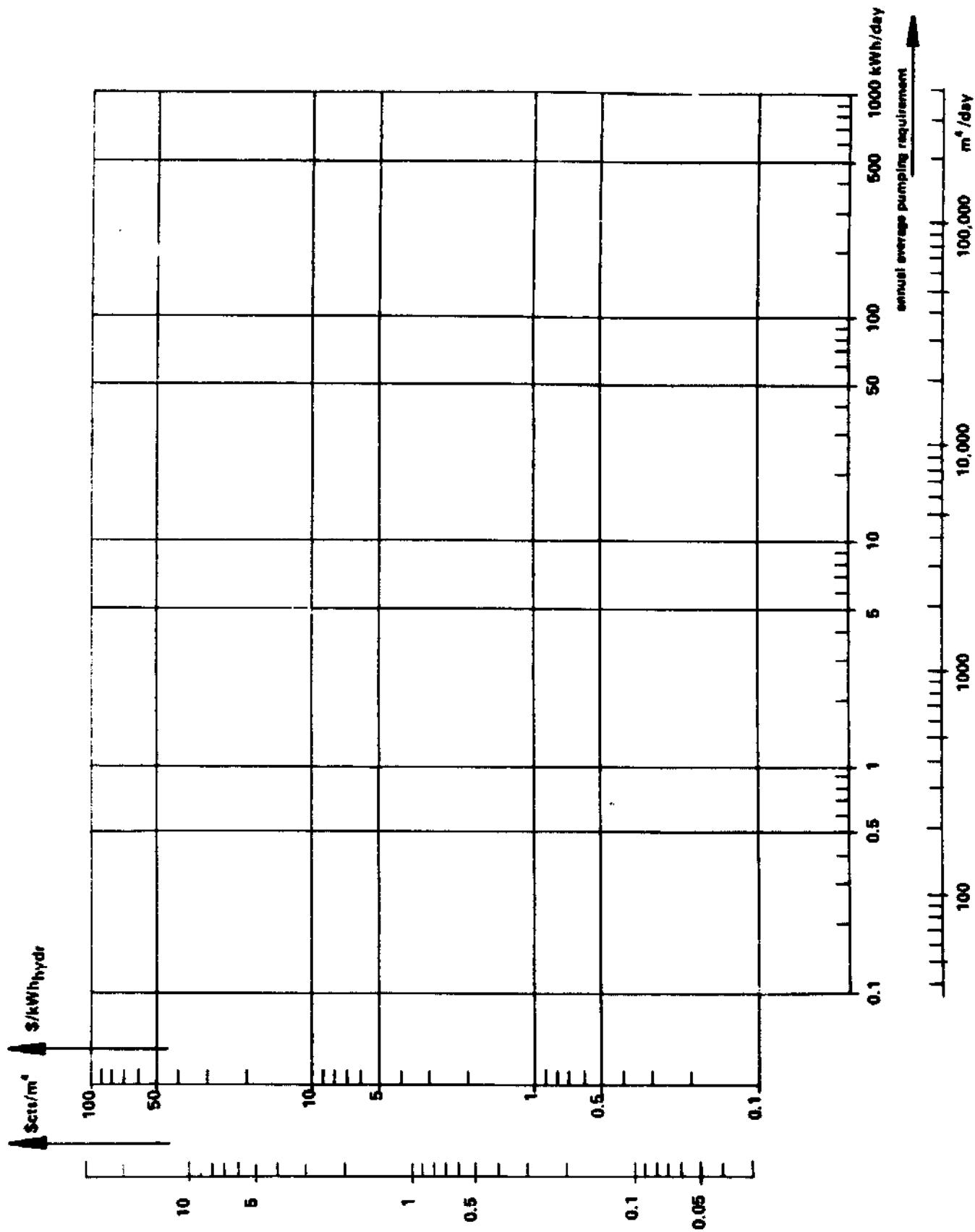

Format sheet for generalised cost comparison.

Appendix F  
EXAMPLE TENDER DOCUMENTS FOR THE  
PROCUREMENT OF WIND PUMPS

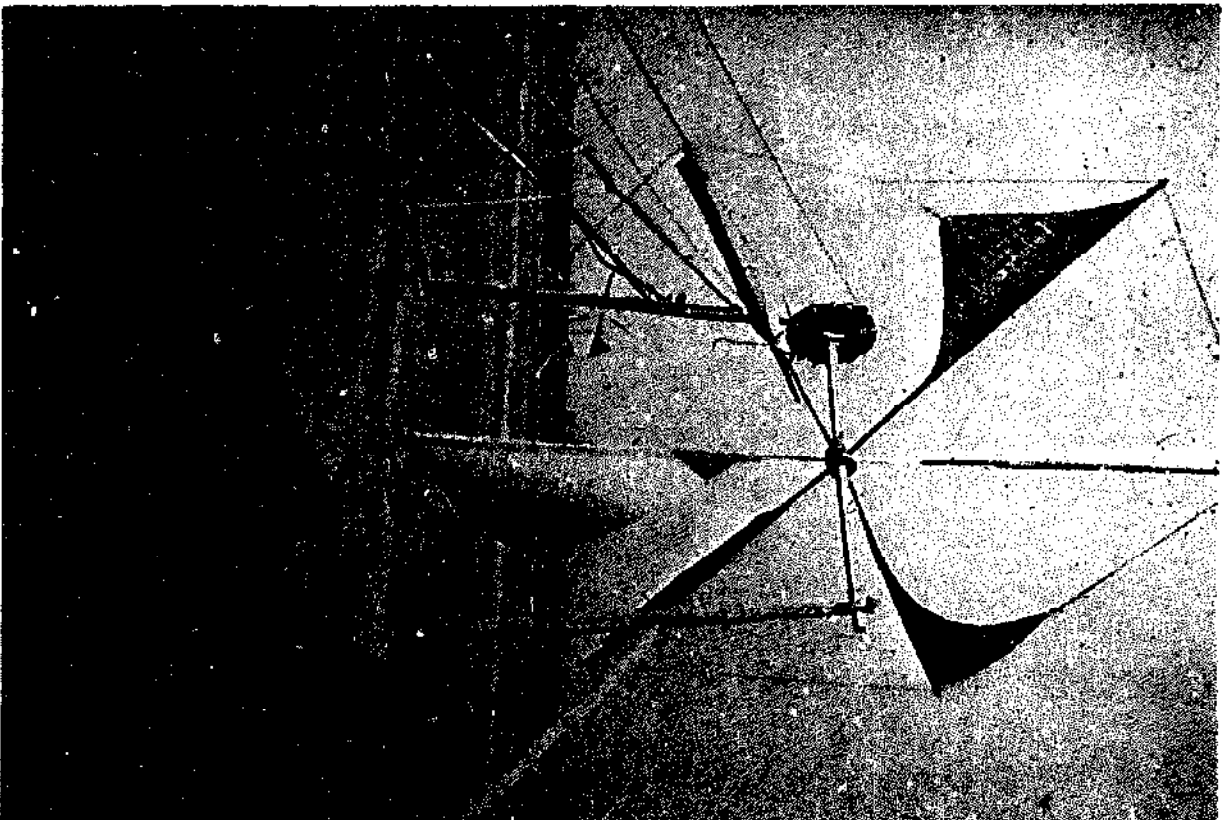

*Local design of low head wind pump in Thailand, used for  
pumping water into salt ponds.*

## Appendix F

# EXAMPLE TENDER DOCUMENTS FOR THE PROCUREMENT OF WIND PUMPS

The tender document presented here was developed by the Global Solar Pumping Project of the World Bank and UNDP, carried out by IF Power and Halcrow and partners and published in the solar pumping handbook (reference 1). With some minor modifications it has proved to be very suitable for wind pumps.

A more elaborate procedure for organizing a call for tenders has been established by the FIDIC, International Federation of Consulting Engineers (reference 16a). As it was developed especially for large civil engineering projects, it is not very suitable for the procurement of wind pumps. However, it may be a useful guideline when subcontracting projects requiring large numbers of wind pumps.

### Contents

1. Instructions to tenderer
2. System specification
3. Questionnaire for tenderers
4. Price and delivery

### Notes for purchaser

The following tender documents are given for guidance only and may need modification for a particular purchaser's needs.

The items listed below must be completed by the purchaser prior to issue of the document:

- F.1.1. Complete dates for tender procedure.
- F.2.1. Specify application and location of system.
- F.2.2. Specify maximum sizes for containers in the shipment.
- F.2.3. Insert environmental conditions for application.
- F.2.6. Details of the site and application to be provided. Table 1 should specify the month by month water requirement, and Figure 1 should indicate the layout of the proposed site for the system.
- F.2.9. Specify the language in which installation instructions are to be submitted.

## F.1. Instructions to tenderers

### F.1.1. Tender procedure

Tenders are required for a wind pump system as described in the specification. The schedule for purchase of the system is as follows:

Tender forms issued by	.....(day).....(month)....(year)
Completed tenders to be returned by	.....(day).....(month)....(year)
Tenders awarded by	.....(day).....(month)....(year)
Systems to be delivered by.....	

The original tender shall be in the ..... language and shall be filled out in ink or typewritten and will be made a part of the awarded contract.

### F.1.2. Adjudication process

Tenders will be primarily considered for:

- Performance
- Durability
- Cost effectiveness

The purchaser will not be bound to award a contract to the lowest, or any tenderer.

## F.2. Specification

### F.2.1. Scope

This specification is for the design, manufacture, supply and delivery of a complete self-contained wind pump system suitable for irrigation\*/water supply\* use in .....

(\* delete as appropriate)

The system to be supplied shall include:

- Windmill: head, rotor, transmission, vane, safety system
- Tower
- Well top and related parts such as pump rod sealing, air chamber(s), check valves
- Pump with pump rods and connection parts
- Pipework (inside/outside well)
- All fixings and auxiliaries necessary for complete construction and commissioning
- Tools needed for assembly and maintenance
- Spare parts
- Documentation

The clauses which follow outline the design parameters and other requirements to be observed for the fulfilment of the contract.

### **F.2.2. Design**

The complete system shall be robust, and capable of withstanding hard usage in a harsh environment. It shall be resistant to damage from accidental misuse and reasonably resistant to vandalism and the attentions of animals, wild or domestic.

The system shall be designed for assembly, operation and servicing by unskilled personnel under the guidance of a trained technician. The requirement for special tools or instruments to install and maintain the system shall be minimized and all special tools needed for installation shall be supplied with the system except for the hoisting tools, for which the specifications must be clearly indicated. Foundations or other preparatory work shall be as simple as practicable, and will be clearly specified by the tenderer.

The system shall be designed for assembly from units which can be packed in containers small enough to be easily handled and transported. The maximum permitted dimensions for any one unit are:.....

The system shall be designed to operate for a long lifetime with minimum deterioration of performance. The design life of the whole system shall be at least ten years with a minimal need for replacement of moving parts and wearing components such as cup leathers and pump rod sealings. Routine maintenance shall be minimized and maintenance work necessary shall be as simple as possible, requiring only a few basic tools for its execution.

### **F.2.3. Environmental conditions**

The system shall be resistant to the following environmental conditions:

- Wind speeds up to ..... m/s (e.g. 40 or 50 m/s)
- Typhoon or hurricane winds up to ..... m/s
- Sand storms
- Salty atmosphere
- Water containing particles up to ..... mm (e.g. 0.3 mm)
- Water containing dissolved solids up to ..... mg/l (e.g. 500 mg/l)  
Main type of dissolved solids: .....(e.g. NaCl)
- Overnight freezing temperatures
- .....

The contractor shall state the limits of environmental conditions under which the system is designed to operate.

### **F.2.4. Materials and workmanship**

All materials used shall be of first class quality in accordance with relevant national standards, carefully selected for the duty required, with particular regard given to resistance against corrosion and long-term degradation. Workmanship and general finish shall be in accordance with the best modern practice.

### **F.2.5. Standards**

The design and construction shall comply with current standards for mechanical constructions. Any performance tests shall comply with the IEA recommendations for wind turbine testing.

### **F.2.6. Performance requirement**

#### **F.2.6.1. Location**

The pumping system to be supplied by the contractor is to be located as detailed below:

- Name of nearest village/town
- Country
- Latitude
- Longitude
- Water source (river/canal/open well/borehole)
- Height of location above sea level

#### **F.2.6.2. Required performance**

The required performance of the system is summarized in Table 1<sup>1</sup>, along with the typical environmental conditions for the location. The system should provide average daily outputs as specified in Table 1 for each month, provided that the specified monthly mean average wind speed for the month is met or exceeded. The tenderer shall complete Table 1, item 6, using performance data for the system offered.

#### **F.2.6.3. Installation details**

A sketch of the site is shown in Figure 1<sup>2</sup>. The total static head at the site is detailed in Table 1 and includes ..... meters head for discharge above ground level (Figure 1). The well/borehole details are (when applicable):

- diameter ..... m
- lining/casing depth ..... m
- drawdown ..... m at ..... l/sec
- location of intake filter

Alternatively, if installation details are not yet known, the tenderer may indicate recommended pumps for different pumping heights and different wind regimes.

---

<sup>1</sup> See page F-11.

<sup>2</sup> See page F-10.

### **F.2.7. Spare parts**

The contractor shall supply with the system sufficient consumable items such as cup leathers, and pump rod sealing material, which may need replacement to last for 10,000 hours of operation. Spare nuts, bolts, washers etc. likely to be lost during shipment and erection shall also be supplied at the time of shipment.

### **F.2.8. Packing for shipment**

All equipment shall be carefully and suitably packed for the specific means of transportation to be used, so that it is protected against all weather and other conditions to which it may become subject.

Before despatch all equipment is to be thoroughly dried and cleaned internally. All external unpainted ferrous parts and machined surfaces shall be protected by an approved proprietary preservative, all openings shall be covered and all screwed connections plugged unless otherwise agreed.

Where moisture absorbants have been used for protection from corrosion during storage or transit, adequate information of their location and warning as to their removal shall be clearly indicated.

### **F.2.9. Documentation**

Prior to shipment of the equipment, the contractor shall submit to the purchaser the following documents: (Copies should also be shipped with system.)

- A list of components and assemblies to be shipped including all spare parts and tools.
- The size, weight and packing list for each package in the shipment.
- Specifications for the foundation.
- Assembly instructions.
- Operating instructions.
- Instructions for all maintenance operations and the schedule for any routine maintenance requirements.
- Sufficient descriptions of spare parts and components to permit identification for ordering replacements.
- Revised drawings of the equipment as built if different from the approved proposals.

All documents shall be in the ..... language.

### **F.2.10. Tools**

The contractor shall provide with the pumping system two sets of any special tools and other equipment that are required for operating, maintaining and repairing the equipment. Clear specifications will be provided for hoisting equipment, such as gin pole and winches.

#### **F.2.11. Technical support after shipment**

The contractor shall be prepared to provide advice during the installation and warranty<sup>3</sup> periods of the equipment supplied under the contract. For this purpose he shall nominate a member of his executive or technical staff who may be contacted during normal office hours.

#### **F.2.12. Insurance**

The contractor shall arrange for the equipment to be comprehensively insured for its full value from the time it leaves his premises until clearance from customs at the point of entry into the country of installation/until arrival at the site of installation.

#### **F.2.13. Warranty <sup>3</sup>**

The contractor shall specify the period of the warranty together with a list of items covered under the warranty.

#### **F.2.14. Service by others**

The following services after delivery of the equipment will be carried out by others:

- Clearance of the equipment through customs.
- Transport to a location specified by the purchaser, (including insurance).
- Storage prior to erection if necessary.
- Construction of foundations.
- Erection and setting to work of the equipment.
- Operation of the equipment.
- Routine maintenance (as distinct from any repairs or maintenance required under the terms of the warranty) <sup>3</sup>.

---

<sup>3</sup> A fully effective warranty will probably only be given if the system has been completely installed and commissioned by the contractor. Otherwise it will be difficult to distinguish whether a breakdown was caused by the equipment or its installation.



### **F.3. Questionnaire for tenderers**

Tenderers are asked to supply the following information to demonstrate their ability to meet the requirements of the project. All information will remain confidential.

#### **F.3.1. General information**

##### **F.3.1.1. Name of tenderer**

Individual contact.....

**F.3.1.2. Address** .....  
.....**Tel**.....**Telex**.....

**F.3.1.3. Legal status (e.g. limited company)**.....

**F.3.1.4. Country in which registered**.....

**F.3.1.5. Total number of employees**.....

#### **F.3.2. Associated or subsidiary companies**

**F.3.2.1. Briefly describe relationship with associated or subsidiary companies.**

**F.3.2.2. Overseas manufacturing/assembly subsidiaries (location and scope).**

**F.3.2.3. Licensees overseas for products (location, products).**

#### **F.3.3. Experience of tenderer**

**F.3.3.1. Number of years of experience with wind pump systems.**

**F.3.3.2. Products developed.**

**Experience with water pumping windmill systems:**

**F.3.3.3. Number of years involved**.....

**F.3.3.4. Number of systems installed worldwide**.....

**F.3.3.5. Number of systems installed in developing countries**.....

**F.3.3.6. Number of systems now operational**.....

**F.3.3.7. Special feature(s) of systems developed**.....

**F.3.3.8. List of attached literature on systems currently available.**

**F.3.4. Source of supply**

**F.3.4.1. Items manufactured by contractor**

**F.3.4.2. Items bought in from suppliers**

**F.3.5. Maintenance requirements (detail and frequency)**

- Machine, windmill head
- Yawing and safety system
- Transmission
- Pump
- Pipework and ancillaries

**F.3.6. Spare parts and tools**

Tenderer to list all spare parts supplied as required to last for 10 years of operation.

Tenderer to list all tools or equipment supplied for erecting, operating, maintaining and repairing the equipment.

**F.3.7. After sales service**

Tenderers to list names, addresses, telex and telephone number of persons and organizations who may be contacted for advice during the period of installation and operation of the equipment:

## F.4. Price and delivery

Terms of payment:

Item	Description	Currency	Price
1.	Wind pump system, including packing ready for despatch.		
2.	Transportation (from place of manufacture to point of entry) of complete pumping system, including insurance.		
3.	Other		.....
	Total contract price		.....
4.	Spare parts		
	- cup leathers		
	- pump rod sealing		
	- pump rods and couplings		
	- bearings		
	- springs		
	- others		

Delivery of complete pumping system to be ..... weeks from receipt of order.

## Annexes

Table 1 For format, see page F-11 (see also example Table 3.8).

Figure 1 For examples of typical layouts, see Figure F.1 (page F-10).

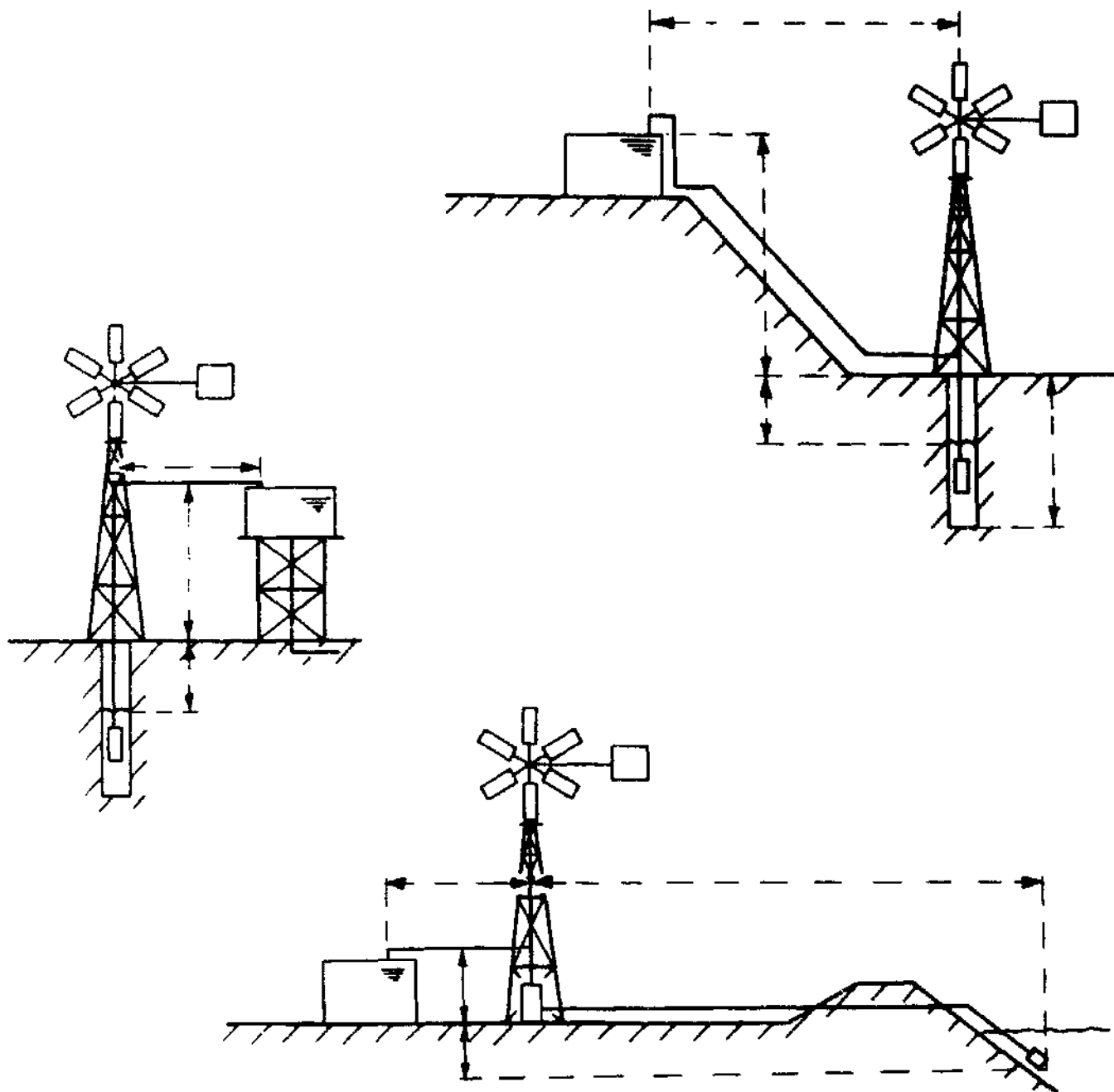
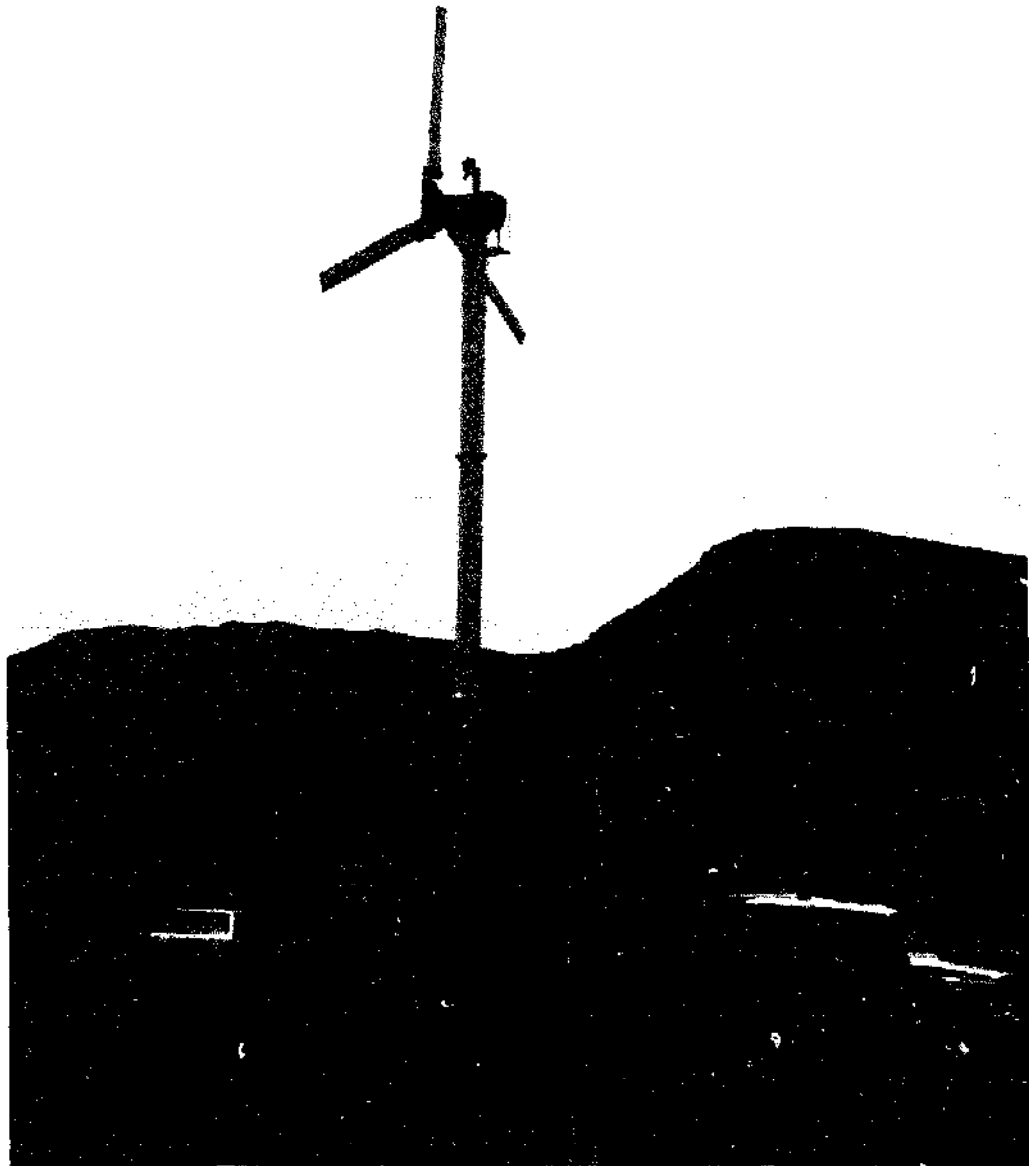

Figure P.1. Examples of layout of wind pumping systems. Indicate distances and heights for tender document.

<b>WIND PUMP PERFORMANCE SPECIFICATION</b>												
Location.....Height above sea level.....m .....												
1. Water source				Type..... Distance (for surface pumping).....m Diameter (for wells).....mm Water level (when pumping).....m								
2. Delivery system				Type..... Length.....m Pipe diameter.....mm Efficiency.....%								
3. Storage system				Type.....; Volume.....m <sup>3</sup> Height.....m								
4. Design month details				Month..... End use water requirement.....m <sup>3</sup> /day Pumped water requirement.....m <sup>3</sup> /day Hydraulic power requirement.....W Average wind speed at hub height.....m/s								
5. Wind regime and water requirement												
	Jan	Feb	Mar	Apr	May	Jun	Jul	Aug	Sep	Oct	Nov	Dec
average wind speed at hub height (m/s)												
pumped water requirement (m <sup>3</sup> per day)												
6. Windmill specification				Tower height.....m Machine type..... rotor diameter.....m stroke.....mm Pump type..... cylinder diameter.....mm								

Table 1. Format sheet (E-6) for specification of wind pump performance.

Appendix G  
GLOSSARY  
LIST OF SYMBOLS  
CONVERSION OF UNITS



*Wind electric pumping system (WEPS) on Cape Verde. A Lagerwey wind turbine of 10.6 m rotor diameter is installed on an 'achada', well exposed to the wind, and drives an electric deep-well pump in the valley. Note the hydraulic jack at the tower base for erection without the need for a crane.*

## Appendix G

### GLOSSARY, LIST OF SYMBOLS AND CONVERSION OF UNITS

#### G.1. Glossary

<b>Anemometer</b>	Instrument to measure wind speed.
<b>Average annual capital cost</b>	Fixed annual amount to be paid to make a certain amount of capital available.
<b>Annuity factor</b>	Multiplication of the cost of investment by this factor yields the average annual capital cost.
<b>Annual recurrent costs</b>	Costs which occur every year in more or less the same way, related to operation and maintenance.
<b>Availability</b>	
- Output availability	Percentage of time during which sufficient wind is available to operate a wind pump at more than 10% of its average output.
- Technical availability	Percentage of time that the wind pump is fully operational, and ready to pump water if sufficient wind is available.
<b>Back-geared wind pump</b>	Wind pump having a gear box to reduce the rpm of the pump.
<b>Balanced</b>	A wind pump with a balanced pump rod is equipped with some kind of counterweight (on a lever, or on the spokes of the rotor) to counterbalance the weight of the pump rod, and sometimes (part of) the weight of the water column.
<b>Darrius rotor</b>	Type of a vertical axis wind machine with two or three aerofoil shaped blades, looking like an "eggbeater".

<b>Deep well turbine pump</b>	Multistage centrifugal pump, to be installed in a tubewell and to be driven by a long rotating shaft, guided inside the delivery pipe.
<b>Derating factor</b>	Ratio of mechanical power demanded by a pump and the rated mechanical power of the engine used to drive the pump.
<b>Design month</b>	The "worst" month, i.e. the month with the highest ratio of power demand (for pumping) to power resources (such as wind and solar). A pumping system must be designed for this month.
<b>Design tip speed ratio</b>	Tip speed ratio at which a wind rotor delivers its maximum power.
<b>Design wind speed of a wind pump</b>	Wind speed at which the wind pump has the highest overall power coefficient.
<b>Diurnal wind pattern</b>	Average course of the wind speed during the day.
<b>Doldrums</b>	Region of low wind speeds around the equator.
<b>Drawdown</b>	Lowering of the water table inside a well due to pumping.
<b>Dynamic head</b>	Total pumping head, including static head, drawdown and pressure loss in pipes.
<b>Dynamic level</b>	Water level in a well below ground level when pumping, i.e. the sum of static level and drawdown.
<b>Efficiencies</b>	
- <b>Field application efficiency</b>	Ratio of useful water taken up by the crop to water delivered to the field.
- <b>Mechanical efficiency of a wind pump</b>	Energetic efficiency of the transmission and pump, i.e. the ratio of hydraulic power output and mechanical power delivered by the wind rotor.
- <b>Subsystem daily energy efficiency of a solar pump</b>	- Ratio of hydraulic energy output over a day to electrical energy output of a PV array.
- <b>Volumetric efficiency of a piston pump</b>	- Ratio of water delivered per stroke to volume displaced by the piston.



<b>- Water conveyance efficiency</b>	Ratio of water delivered to the field to water provided at the outlet of the pump or storage tank (if installed).
<b>Energy production coefficient of a wind pump</b>	Coefficient used in calculating the average output of a wind pump. It reflects the matching of a wind machine and pump in relation to the wind regime.
<b>Evapotranspiration</b>	Loss of water through the leaves of a crop; water requirements for crops are calculated based on the evapotranspiration rate.
<b>Field capacity</b>	The maximum amount of water held in the soil that is useful to the crop.
<b>Headloss</b>	Pressure drop over pipes (transporting water) due to friction.
<b>Hub height</b>	Height of center of rotor of windmill above ground level.
<b>Hydraulic power</b>	Power needed to pump water.
<b>Hysteresis</b>	The dependence of the state of a system on its previous history, generally in the form of a lagging of a physical effect behind its cause.
<b>Matching of a wind machine and pump</b>	Choosing the size of the pump in relation to the size of the wind machine in such a way that a good compromise is obtained between the conflicting demands of high output and high output availability.
<b>Nomogram</b>	Graphical representation of a calculation procedure.
<b>Output of a wind pump</b>	Amount of water pumped.
<b>Overall power coefficient</b>	Coefficient indicating the instantaneous effectiveness of a wind pump in converting wind power into hydraulic power.
<b>Peak watts (Wp)</b>	The output of a PV module or array under reference conditions, a.o. a solar irradiation of $1000 \text{ W/m}^2$ .
<b>Permanent wilting point</b>	Quantity of water held in soil, below which the crop dies.
<b>Potential wind speed</b>	Wind speed which would be observed in completely flat and open terrain.

<b>Power coefficient of a wind rotor</b>	Coefficient indicating the instantaneous effectiveness of a wind rotor in converting wind power into mechanical shaft power.
<b>Prime mover</b>	The power source for a pumping system.
<b>Pumping head</b>	Pressure difference to be overcome by a pump, expressed in units of equivalent height.
<b>Pumping height</b>	Vertical geometric distance over which a pump has to lift water.
<b>PV or solar cell</b>	A semi-conductor device which can convert solar radiation directly into electricity.
<b>Quality factor, or output quality factor</b>	Factor relating average hydraulic power output of a wind pump to its rotor size and the average wind speed. It summarizes the effects of overall power coefficient and energy production coefficient.
<b>Roughness or terrain roughness</b>	Parameter related to the type of terrain and used to calculate the retardation of wind flow above the terrain.
<b>Rural water supply</b>	Includes water supply for drinking, washing, cooking, general domestic use, and for livestock.
<b>Savonius rotor</b>	Type of a vertical axis wind machine having two or three blades in the shape of "half oil drums".
<b>Safety system of a wind pump</b>	System to protect the machine in storms. For mechanical wind pumps it is usually combined with the system to direct the machine into the wind at lower wind speeds.
<b>Sensitivity analysis</b>	If a quantity (e.g. a price) which depends on a number of parameters has been calculated for a base set of prescribed values of these parameters, then a sensitivity analysis aims at calculating the relative change of the value of the quantity by varying each of these parameters separately relative to their base value.
<b>Solar irradiation</b>	Power received per unit area from the sun.
<b>Starting nozzle</b>	Small hole in the piston of a piston pump, facilitating starting of a wind pump in light winds.

<b>Start wind speed</b>	Wind speed at which a wind pump just starts running in a gradually increasing wind.
<b>Static head</b>	The vertical height over which water must be pumped.
<b>Stop wind speed</b>	Wind speed at which a wind pump just stops running in a gradually decreasing wind.
<b>Stroke volume</b>	Geometric volume displaced by the piston of a piston pump in each stroke.
<b>Submersible pump</b>	Assembly of centrifugal pump (mostly multistage) and electric motor together installed under water.
<b>Tip speed ratio of a wind rotor</b>	Ratio of the speed of the tip of the blade of a wind rotor to the wind speed.
<b>Transmission of a wind pump</b>	Complete system transmitting the shaft power of the wind rotor to the pump. Including shafts, gear box, excentric, pump rods, pump rod guides.
<b>WEPS Wind electric pumping system</b>	Stand-alone wind electric generator, driving an electric pump.
<b>Wind machine</b>	Prime mover driven by wind power. It may be used to drive any kind of load: pump, electric generator, etc.
<b>Windmill</b>	General term, meaning wind machine, wind electric generator, wind pump, etc.
<b>Wind pump</b>	Water pumping device driven by wind power. The most common type is the classical wind pump in which a piston pump is driven through a mechanical transmission. The term is general, and is also used to indicate wind electric pumping systems, systems with pneumatic or hydraulic transmission, etc.

## G.2. List of symbols

A	Rotor area $A = \frac{1}{4} \pi D^2$	(m <sup>2</sup> )
AAC	Average annual cost	
AACC	Average annual capital cost	
ANN	Annuity	
ARC	Annual recurrent cost	
C <sub>E</sub>	Energy production coefficient $C_E = \frac{P_{hydr}}{\frac{1}{2} \rho A V^3 (C_P \eta)_{max}}$	(-)
C <sub>P</sub>	Power coefficient $C_P = \frac{P}{\frac{1}{2} \rho A V^3}$	(-)
C <sub>P</sub> η	Overall power coefficient $C_P \eta = \frac{P_{hydr}}{\frac{1}{2} \rho A V^3}$	(-)
C <sub>Q</sub>	Torque coefficient $C_Q = \frac{Q}{\frac{1}{2} \rho A V^2 R}$	(-)
D	Rotor diameter	(m)
D <sub>p</sub>	Pump diameter	(m)
E	Energy	(J) or (kWh)
g	Acceleration of gravity g = 9.8	(m/s <sup>2</sup> )
H	Height	(m)
I	Investment	
i	Transmission ratio i < 1 for back-g geared wind pumps	(-)
n	Number of years	
P	Power	(W)

$P_{hydr}$	Hydraulic power $P = \rho_w g q H$ with $\rho_w = 1000 \text{ kg/m}^3$	(W)
$P_{wind}$	Specific wind power $p = \frac{1}{2} \rho V^3$	(W/m <sup>2</sup> )
$q$	Flow rate, pumping rate	(l/s) or (m <sup>3</sup> /s) or (m <sup>3</sup> /day)
$Q$	Torque Volume of water	(Nm) (m <sup>3</sup> )
$R$	Radius of rotor (= $\frac{1}{2} D$ )	(m)
$r$	Interest rate	(%)
$s$	Stroke	(m)
$T$	Time duration	(s) or (hrs)
$V$	Wind speed	(m/s)
$\bar{V}$	Average wind speed	(m/s)
$V_d$	Design wind speed	(m/s)
$V_{start}$	Start wind speed	(m/s)
$V_{stop}$	Stop wind speed	(m/s)
$z_o$	Roughness height	(m)
$\beta$	Output quality factor $\beta = \frac{P_{hydr}}{A \bar{V}^3} = \frac{1}{2} \rho (C_P \eta)_{max} C_E$	(-)
$\eta$	Efficiency	(-)
$\eta_{mech}$	Mechanical efficiency	(-)
$\eta_{vol}$	Volumetric efficiency	(-)
$\bar{V}_s$	Stroke volume $\bar{V}_s = \frac{1}{2} \pi D_p^2 s$	(l)
$\lambda$	Tip speed ratio	(-)
$\lambda_d$	Design tip speed ratio	(-)
$\pi$	3.14	
$\rho$	Density of air Common value: $\rho = 1.2$	(kg/m <sup>3</sup> )

$\rho_w$	Density of water $\rho = 1000 \text{ kg/m}^3 = 1 \text{ kg/l}$	( $\text{kg/m}^3$ )
$\Omega$	Angular velocity	(rad/s)

### G.3. Conversion of units

#### Power

	W	kWh/day	MJ/day	$\text{m}^4/\text{day}^*$
W	1	0.024	0.0864	8.816
1 kWh/day	41.67	1	3.6	367.3
1 MJ/day	11.57	0.2778	1	102.04
1 $\text{m}^4/\text{day}^*$	0.1134	0.002722	0.0098	1

\* Conversion based on  $9.80 \text{ m/s}^2$ , an average value between latitudes from  $-50^\circ$  to  $+50^\circ$ .

#### Pumping rate

	l/s	$\text{m}^3/\text{hr}$	$\text{m}^3/\text{day}$
l/s	1	3.6	86.4
$\text{m}^3/\text{hr}$	0.2778	1	24
$\text{m}^3/\text{day}$	0.01157	0.4167	1

1 US gallon = 3.785 l

1 Imp. gallon = 4.546 l

#### Wind speed

	m/s	km/hr	mph	knots
1 m/s	1.000	3.600	2.237	1.944
1 km/hr	0.278	1.000	0.622	0.540
1 mph	0.447	1.609	1.000	0.869
1 knot	0.514	1.852	1.151	1.000

## REFERENCES

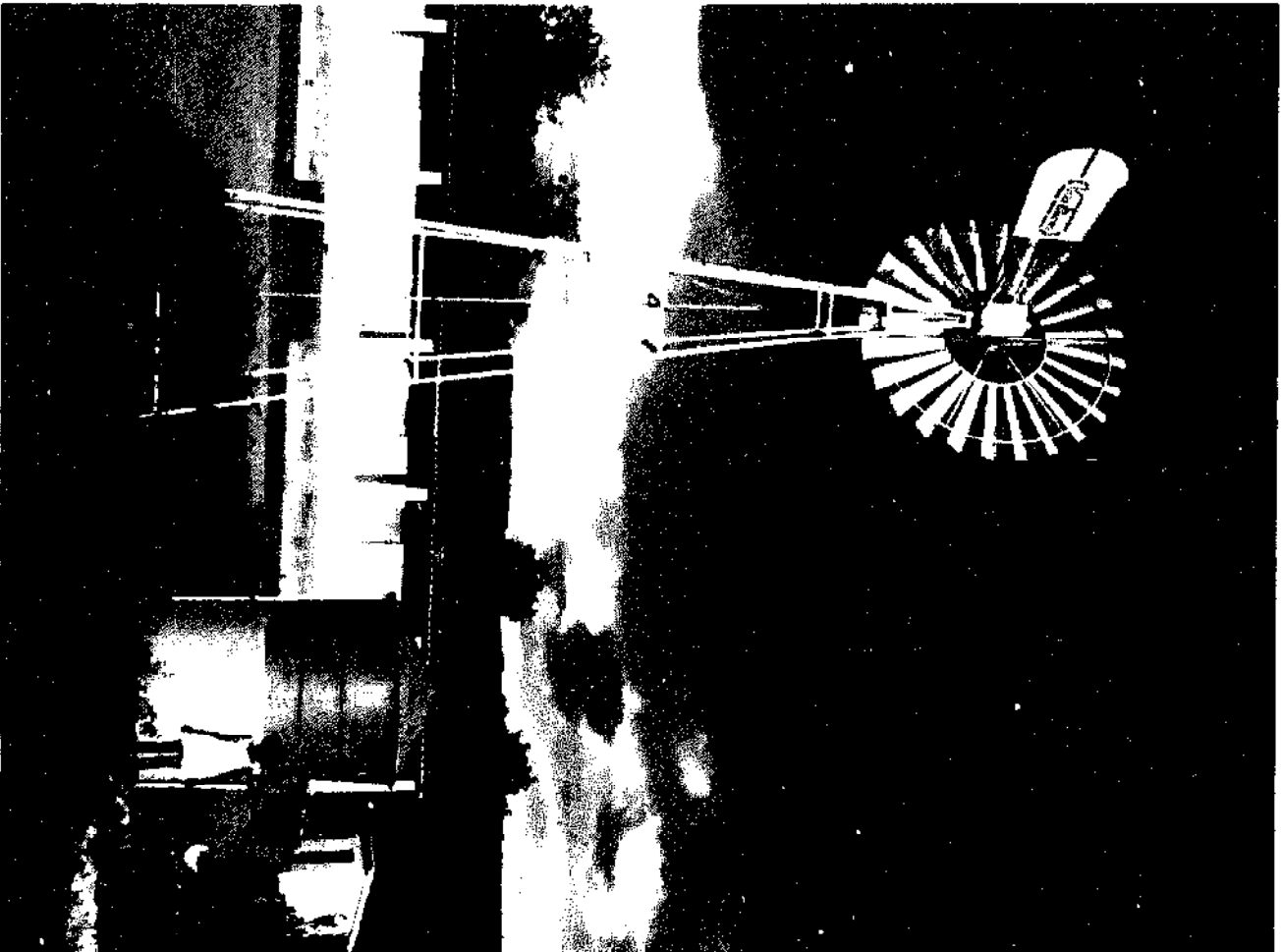

*Water supply of a small community in the dry interior of Paraita state, Brazil, by means of a Vida Eterna wind pump of conventional design.*

## REFERENCES

This section of the handbook contains references which may guide the reader who wishes to proceed further into a specific area of interest. It also contains references to the material on which the handbook was based.

### Further reading: General

1. Jeff Kenna, Bill Gillett  
Solar Water Pumping, a Handbook  
IBRD, International Bank for Reconstruction and Development, USA, Washington  
Sir William Halcrow and Partners, UK  
Intermediate Technology Power, London, UK  
Intermediate Technology Publications, 1985.
2. Wind Technology Assessment Study  
Volume I: Wind study report  
Volume II: Annexes to report  
UNDP project GLO/80/003, executed by the World Bank  
Intermediate Technology Power, February 1983.

### Further reading: The technology

3. E.H. Lysen  
Introduction to Wind Energy  
CWD, Consultancy Services Wind Energy Developing Countries, Amersfoort,  
The Netherlands, CWD 82-1, 2nd edition, May 1983.
4. D. Both, L.E.R. van der Stelt  
Catalogue of Wind Machines  
WOT, Working Group on Development Techniques, Enschede, the Netherlands  
CWD, Consultancy Services Wind Energy Developing Countries, Amersfoort,  
The Netherlands, CWD 82-2, February 1984.
5. Peter Fraenkel  
The Power Guide, a catalogue of small scale power equipment  
Intermediate Technology Publications, London, UK, 1979.



**Further reading: Site evaluation**

6. H.L. Wegley, et al.  
A Siting Handbook for Small Wind Energy Conversion Systems  
Battelle Pacific Northwest Laboratory, Richland,  
Washington, USA  
Wind Books, Livingston, MT, USA, 1979.
7. Meteorological Aspects of the Utilization of Wind as an Energy Source  
WMO, World Meteorological Organization, Geneva, Switzerland,  
Technical Note No. 175, 1981.
- 7a. E.H. ABu Bakr, et al.  
A method to obtain a wind model for the boundary layer in a representative  
tropical region.  
EWEC, European Wind Energy Conference Rome, October 1986.
8. J. v. Meel  
Assessment of Wind Resources  
Discussion paper for the workshop on a Global Wind Pump Testing Programme,  
October 1984  
The World Bank, UNDP  
CWD, Amersfoort, the Netherlands, August 1984.
9. J. Doorenbos, W.O. Pruitt  
Crop water requirements  
FAO, irrigation and drainage paper No. 24  
FAO, Rome, 1977.
10. A. van Vilsteren  
Aspects of irrigation with windmills  
TOOL, Amsterdam, The Netherlands  
CWD, Amersfoort, The Netherlands, CWD 81-4, January 1981.
11. Manual for rural water supply  
SKAT, Swiss Center for Appropriate Technology, St. Gall, Switzerland,  
publication No. 8, 1980.
12. E.H. Hofkes  
Alternative energy sources for drinking water supply in developing countries.  
IRC, International Reference Centre for Community  
Water Supply and Sanitation, draft report,  
December 1984, The Hague, The Netherlands.

**Further reading: Economic assessment**

13. A.M. Mueller  
Farm economics of water lifting windmills.  
A guideline on economic and financial analyses for feasibility studies.  
CWD, Consultancy Services Wind Energy Developing Countries, Amersfoort,  
The Netherlands, CWD 84-1, January 1984.
14. A.M. Mueller, W.A.M. Jansen  
Cost analysis of water-lifting windmills and diesel-powered pumps used for  
small-scale irrigation.  
CWD, Consultancy Services Wind Energy Developing Countries, Amersfoort,  
The Netherlands, CWD 84-3, June 1984.
15. Horst Finck, Gerhard Oelert  
A guide to the financial evaluation of investment projects in energy supply.  
GTZ, Deutsche Gesellschaft für Technische Zusammenarbeit, Eschborn, Germany,  
GTZ, No. 163, 1985.

**Further reading: Procurement, installation and monitoring**

16. N.W.M. Pieterse, G.C.J.J. Stevens  
Manpower Profiles in the Utilization of Wind Energy.  
ILO, International Labour Office.  
CWD, Consultancy Services Wind Energy Developing Countries, Amersfoort,  
The Netherlands.  
DHV, Consulting Engineers, Amersfoort, The Netherlands,  
December 1985.
- 16a. Tendering procedure  
Procedure for obtaining and evaluating tenders for civil engineering contracts.  
FIDIC, International Federation of Consulting Engineers, Lausanne, Switzerland,  
1982.
17. J. v. Meel, R. Schermerhorn, K. Kieft  
Monitoring of water pumping windmills.  
Discussion paper for the workshop on a Global Wind Pump Testing Programme,  
October 1984, World Bank, UNDP,  
CWD, Amersfoort, Netherlands, August 1984.

**References to case studies**

18. W.A.M. Jansen  
Performance tests of kerosene engine pump sets.  
WEU, Wind Energy Unit, Water Resources Board, Colombo, Sri Lanka,  
August 1979.

19. J.A.C. Vel, L.R. v. Veldhuizen  
A model for the economics of small-scale irrigation with windmills in Sri Lanka.  
CWD, Consultancy Services Wind Energy Developing Countries,  
CWD 82-2, October 1981.
20. A.M. Mueller, A.D.M. Karunaratne  
Windmill pilot projects 1981.  
Wind Energy Unit, Water Resources Board, Colombo, Sri Lanka, WEU 82-5,  
September 1982.
21. K.S. Fernando  
Wind energy utilisation for agriculture in Sri Lanka.  
A Consultancy Report to the Food and Agriculture Organisation  
Wind Energy Unit, Water Resources Board, Colombo, Sri Lanka, October 1983.
22. Martin Greeley  
Rural Energy Technology Assessment: A Sri Lanka Case Study.  
Institute of Development Studies, University of Sussex, Brighton, UK.  
Paper presented at the Second International Workshop on the Food-Energy Nexus,  
and Ecosystems held in New Delhi, India, February 1986.
23. Joaquim Delgado, Antonio Gomes, Allan H. Miller, Kees Kempenaar  
Water from wind power.  
Report of the evaluation mission of the MDR/DER renewable energy project,  
Cape Verde.  
Ministry of Rural Development, Cape Verde.  
Ministry of Foreign Affairs, The Netherlands.  
United States Agency for International Development.  
Consultancy Group for Sanitation and Water Management, SAWA, Utrecht,  
The Netherlands, January 1984.
24. Daniel Rodrigues Livramento, David Antonio Cardoso, Filomeno Ferreira Silva,  
Niko Pieterse, Kees Versteegh  
Bilateral project between Cape Verde and the Netherlands "Renewable Energies"  
Final report Phase 2: 1981-1984  
Division for Renewable Energies, Ministry of Rural Development, Cape Verde.  
Consultancy Services Wind Energy Developing Countries, CWD, Amersfoort,  
The Netherlands, July 1984.
25. H.J. van Dijk  
The use of wind pumps for rural water supply and irrigation on Cape Verde.  
International Institute for Land Reclamation and Improvement, ILRI, Wageningen,  
The Netherlands, July 1986.
- 25a. Derek Lovejoy  
Technical note on comparative costs of solar, wind and diesel pumping at village  
sites in Nigeria and Somalia.  
Natural Resources Forum, United Nations, New York, 1985.

### References to background literature

26. Bent Sorensen  
Renewable Energy  
Academic Press, London, 1979.
27. P.T. Smulders  
Wind energy for water pumping in developing countries,  
EWEC, European Wind Energy Conference, Rome, October 1986.
28. E.H. Lysen  
Output predictions for wind turbines (in Dutch).  
ODE, Utrecht, Netherlands, October 1982.
29. E.S. Takle, J.M. Brown  
Note on the use of Weibull statistics to characterize wind speed data  
Journal of applied meteorology, Vol. 17, No. 4, April 1978.
30. J. v. Meel, P. Smulders  
Some results of CWD's test fields. Are the IEA recommendations sufficient for  
windmills driving piston pumps?  
Conference on Small Wind Energy Conversion Systems, BWEA,  
Wind Engineering, Vol. 11, No. 2, 1987.
31. J. v. Meel, P. Smulders  
Field testing of water pumping windmills by CWD.  
EWEC, European Wind Energy Conference, Rome, October 1986.
32. Sten Frandsen, Andrew R. Trenka, B. Maribo Pedersen  
Recommended practices for wind turbine testing. Power performance testing.  
IEA, International Energy Agency, Roskilde, Denmark, 1982.
33. H.J. van Dijk  
Calculation of required storage tank capacity in wind pump irrigation systems.  
Wind Engineering, Vol. 10, No. 4, December 1986.
34. ILACO  
Agricultural Compendium for Rural Development in the Tropics and Subtropics.  
Elsevier Scientific Publishing Company, Amsterdam, The Netherlands, 1981.
35. J. van Meel  
Output prediction model.  
CWD, internal note  
Haskoning, Nijmegen, October 1986.
36. Guide to meteorological instruments and methods of observation.  
WMO, World Meteorological Organization, Geneva, Switzerland, WMO No. 8,  
1983.

**Annex**

**TESTING AND MONITORING OF WIND PUMP SYSTEMS  
IN FIELD CONDITIONS**

**Edited by:**

**Peter Oostendorp**

## Chapter 1

### INTRODUCTION

#### 1.1. The "Handbook for comparative evaluation of technical and economic performance of water pumping systems"

This Annex deals with procedures for testing and monitoring wind pumps used by the owner and supplying drinking water or water for irrigation under field conditions.

The recommendations presented here have been derived from the "Handbook for Comparative Evaluation of Technical and Economic Performance of Water Pumping Systems" (reference 1). This Handbook deals with the evaluation methodology for six alternative pumping techniques:

- Grid Connected Electric Pumps
- Fuel Engine Pumps
- Solar Pumps
- Wind Pumps
- Hand Pumps
- Animal Traction Pumps

At the moment the Handbook is being prepared as a joint-donor effort (CIDA, Canada; DGIS, The Netherlands; FAO, United Nations; GTZ, Federal Republic of Germany; USAID, United States of America). Draft versions have been presented and discussed at a workshop in West Sussex (England, January 1986) and at the Botswana Conference on Water Pumping and Water Lifting (April 1987). Although formulated and commented on by a broad group of experts in the field of rural energy supply, the monitoring procedures given here have not yet been tested in the field; their try-out is planned to start at the end of 1988 and should lead to a final version of the Handbook.

The methods laid down in the Handbook are aimed to standardize the collection of data on alternative pumping systems in field conditions. The data gathered are primarily meant for local use. However they should also be collected in one central point for the sake of comparison, analysis and distribution of results.

For these reasons the user is kindly requested to mail to the editors any comments he/she may have regarding the procedures given here together with a copy of the data collected. Comments and data should be addressed to:

CWD, Consultancy Services Wind Energy Developing Countries  
PO BOX 85  
3800 AB AMERSFOORT  
The Netherlands

## 1.2. Overview of the test procedures

The evaluation procedure starts off with a **System Description**. During this activity the system in its "as-found" condition is described. System Description is dealt with in Chapter 3 of this Annex.

The next step, treated in Chapter 4, is the so-called **Short-Term Test**. This test primarily provides technical performance information about the pumping system (i.e. the windmill, the transmission and the pump). Moreover it is a diagnosis of the technical condition of the system at the start of the evaluation that can be repeated during the testing period as often as desired, e.g. after repairs, overhauls or when the pumping system seems to fail. As a reference, performance data from the manufacturer or designer may be used. Where possible ranges within which values of important parameters normally lie are indicated.

If the Short-Term Tests do not generate contra indications, such as obvious malfunctioning of the system, a **Long-Term Test** is the next step in the procedure. During a longer period of time (at least one year) information on system performance, operation, quality and costs will be gathered. Long-Term Testing produces information on the long-term overall system performance expressed in values averaged over longer periods of time, e.g. a pumped water volume of X cubic meters per month at a monthly average wind speed of Y m/s. Long-Term Testing also includes recording chronologically all relevant occurrences during the test such as system breakdowns, repairs, well running dry, expenses for operation and maintenance of the system, benefits, etc.

The owner/operator will be the major resource person during Long-Term Testing. He takes care of the windpump system daily and he will be asked to keep a regular logbook of all relevant data. The owner/operator needs to be properly motivated to perform this task. Some training might be required to ensure proper logbook keeping. This is an important issue, because an owner/operator will often not be convinced of the need and usefulness of the data to be collected or of the accuracy required. Also recording data may interfere with his own priorities. Establishing a contract with him might be a solution. Regular visits by the team leader and/or the technician will be required to assess which logs are being kept properly and to assure that inadequate records will not be included in the data analysis.

Other resource persons may be the mechanics/technicians taking care of maintenance and repair and extension staff providing guidance/advice in the use of the water. Such persons may fill in relevant information in the logbook and comment on the quality and functioning of the system.

Long-Term Testing is dealt with in Chapter 5.

The tests and procedures are described basically for wind pump systems without back-up systems. If a wind pump system including a back-up system is to be evaluated, there are two possibilities:

1. If the back-up system is very small and is only rarely used it should be neglected. Describe its effects qualitatively in the logbook.
2. If the back-up system produces a substantial output compared with the main system, it is recommended to carry out a simultaneous evaluation of the back-up system. In most cases the back-up system consists of a diesel pump or a hand pump. See reference 1 for the test procedures.

## Chapter 2

# PERSONNEL AND EQUIPMENT REQUIREMENTS

### 2.1. Personnel qualifications

Table 1. gives a survey of the staff required for the system evaluation. It is assumed that the persons working with the recommended procedures are sufficiently educated in the related fields.

For the technician the following skills are required:

- general knowledge of water lifting systems,
- experience in measuring techniques and in the installation, calibration and use of measuring instruments,
- experience in simple data reduction techniques.

It is recommended to appoint someone as team leader during the testing activities. An important task of the team leader is to organize additional training for the technician and owner/operator, if necessary.

Activity	Qualification
<b>Data Collection at the start of the Tests</b> - General information - System description - Description of the site	Team leader Technician Technician
<b>Short-Term Testing</b> - Data collection - Technical data reduction	Technician Technician
<b>Long-Term Testing</b> - Daily observations - Periodical visits to the site - Technical data reduction	Owner/operator Team leader Technician

Table 1. Personnel requirements.



## 2.2. Measurement equipment required

In this section the measurement equipment required for Short-Term Testing and Long-Term Testing is described. The selection is based on accuracy, reliability, availability and ease of operation of the equipment.

Apart from the recommendations given in this section, one should consider thoughtfully the instructions for installation, calibration and use provided by the manufacturer of the instruments.

The various instruments are arranged according to the quantities to be measured.

### Time

To time the start and completion of each measurement a clock should be used. For the timing of the 10-minute periods during Short-Term Testing a clock with a second hand, a digital watch or a stopwatch is required.

### Head

#### a. suction head

For surface water sources or dug wells, the suction head should be measured directly with a measuring stick or tape. Where the horizontal distance between water source and pump is long, a level should be used to get a more accurate reading of the vertical distance. For example a U-shaped transparent hose partly filled with water can be used to indicate points of constant height, even at large distances apart. For bore holes where the water surface is not accessible, a well dipper should be used to measure the suction head.

#### b. discharge head

The discharge head should be measured directly using a measuring stick or tape. During Short-Term Tests, particularly for systems with long or narrow discharge lines a pressure gauge at the pump discharge should be used.

#### c. pressure head

The pressure head should be measured at the boundary of the pumping system by means of a bourdon type pressure gauge.

### Water volume pumped

Water flow should be measured using an integrating flow meter that is able to measure irregular and pulsating flow. Because meters of this kind are usually rather sensitive to clogging, they have to be checked, cleaned and calibrated regularly to prevent errors, especially when the water is not too clean (e.g. when pumped from open dug wells).

In order to avoid these problems as much as possible, it is strongly recommended to use a turbine flow meter of the dry running type, characterized by a turbine axis parallel to the piping in which the water flows more or less straight without change of direction. This will reduce sensitivity to pollution to a high degree. Finally, in order to keep friction losses as low as possible it is important to select a flow meter with a capacity that can easily meet the maximum water flow.

To ensure proper functioning of the flow meter it is very important to prevent air from entering it. The piping should be such that the flow meter cannot run dry when the pumping system is in operation.

As an example Figure 2.1 shows two flow meters (indicated by "F") installed in such a way that when measuring they are always full of water. For this reason flow meters should never be installed at positions "A" or "B". Please note the length of straight pipe upstream of the flow meters.

When there is a risk of a certain air content in the water being pumped (e.g. when part of the system is sub-atmospheric or when an air chamber is fitted with an air supply system), a deaeration vessel is recommended (Figure 2.1). Its diameter should at least be three times the diameter of the discharge pipe in order to generate a sufficiently low vertical water velocity for the air bubbles to escape. In order to minimize turbulence in the vessel, the pipe entering it should be bent at the end towards the wall (see "C" in Figure 2.1).

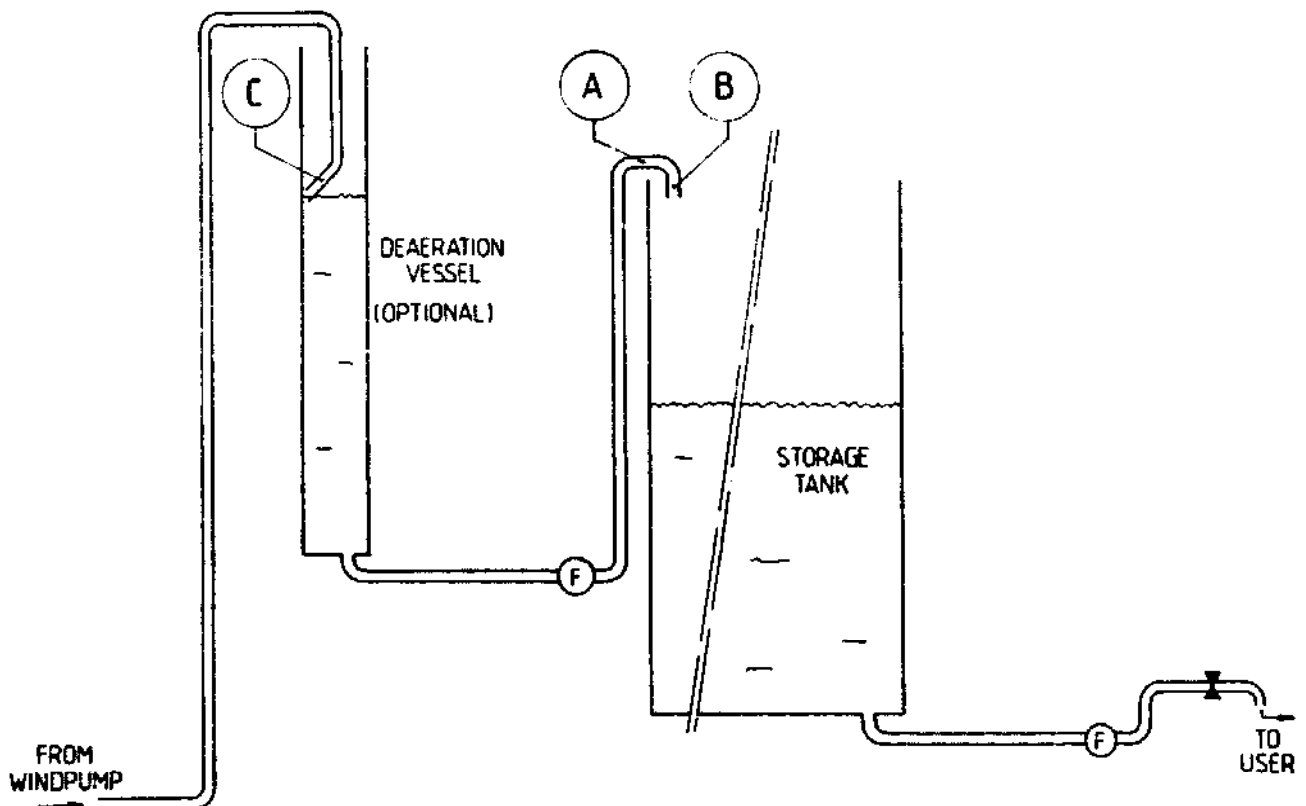

Figure 2.1. Installation of flow meters

When the pump is of the reciprocating type, the deaeration vessel might serve a second function of reducing the flow fluctuations in the meter. As a result a smaller flow meter can be used (selected on maximum average flow instead of maximum peak flow) and the accuracy of the meter will be improved.

**Note:** For wind pumps with a storage tank two integrating flow meters are required.

### **Pump strokes or rotations**

#### **a. reciprocating pumps**

For a reciprocating pump a stroke counter attached to the pump rod should be used. This could be done by means of a simple button-actuated mechanical counter, driven by a disk mounted on the pump rod. Also an internal powered electronic LCD-counter could be applied (at least 8 digits). Alternatively the number of strokes can be obtained by visual observation.

#### **b. rotational pumps**

For centrifugal or screw pumps a revolution counter should be used (e.g. a car odometer attached to any shaft. Take into account the transmission ratio between that shaft and the pump shaft).

For pumps with an essentially constant speed, the rotational speed should be measured by means of a vibrating reed or other mechanical tachometer.

### **Wind speed**

An integrating rotating cup anemometer (e.g. wind-run meter) should be used. It should be positioned at the height of the rotor shaft and at such a place that it is outside the wake of the wind pump during most of the time. This can be achieved by two different methods:

1. If the terrain is flat and without major obstacles (resulting in wind speeds not varying very much over larger distances), place the anemometer at a distance of about 20 times the rotor diameter away from the wind pump: then wake effects for all wind directions can be considered negligible.
2. If the terrain does not meet these conditions, place the anemometer at a distance between 2 and 8 times the rotor diameter away from the windpump and at such a place with respect to the wind pump that it is outside the wake of the wind pump for the predominant wind directions.

To avoid disturbance of the wind speed measurements by the tower in which the anemometer is mounted, the tower height should be chosen such that the anemometer can be installed on top of it.

## Chapter 3

# DATA COLLECTION AT THE START OF THE TESTS

This chapter describes data collection prior to carrying out the tests. The chapter deals with information that is available at the start of the tests; no measurements are required at this stage.

### 3.1. General information

Through completion of Data Sheet 3.1. a general identification of the system under consideration and the persons assigned to carry out the tests will be obtained.

<b>General</b>				
Type of pumping system	:	.....		
Year of installation	:	.....		
<b>Owner of the Pumping System</b>				
Name	:	.....		
Address	:	.....		
Telephone	:	.....		
<b>Location of the Pumping System</b>				
Town/village	:	Latitude	:	.....
District	:	Longitude	:	.....
Country	:	Altitude	:	.....
<b>Supplier of the Pumping System</b>				
Name	:	.....		
Address	:	.....		
Telephone	:	.....		
<b>Institution supporting the evaluation</b>				
Name	:	.....		
Address	:	.....		
Telephone	:	.....		
<b>Names of persons in charge of the tests and evaluation</b>				
Team leader	:	.....		
Technician	:	.....		

Data sheet 3.1. General information on pumping system (to be completed by team leader).

Persons		Function			Experience	
1. Name : (see data sheet 3.1) Address : Telephone :		Owner				
2. Name : Address : Telephone :		Operator				
3. Name : Address : Telephone :		Guard				
4. Name : Address : Telephone :						
5. Name : Address : Telephone :						
	1. Owner	2. Operator	3. Guard	4. .....	5. .....	
Operation						
Guarding						
Maintenance						
Repair						
Selling of water						
Cleaning of site						
.....						
.....						
Basis of involvement						

**Data sheet 3.2. Persons involved in daily care for the system (to be completed by team leader).**

### 3.2. Persons involved

It is important to determine the persons involved in keeping the pumping system in running order and their respective tasks and responsibilities. Such information will be noted in Data Sheet 3.2. It contains three suggestions for functions and six ideas on tasks. Others may be added if deemed appropriate. Further information relates to the basis on which persons involved contribute to the operation of the system (direct beneficiary, family member, paid, etc). In the logbook more information on the types of tasks of the various persons involved may be noted down.

### 3.3. Water source and well construction

Data sheet 3.3 gives a summary of quantitative information on the water source. Not all items are relevant for all types of water sources; please skip them if not applicable.

Source type	:	dug well/river/tube well/.....*
Identification Number	:	.....
Diameter	:	..... [m]
Depth	:	..... [m]
Static ground water level (i.e. without water extraction)		
Maximum value	:	..... [m below ground level]
Minimum value	:	..... [m below ground level]
Capacity	:	..... [m <sup>3</sup> /hour] or [m <sup>3</sup> /day] *
Corresponding lowering of ground water level	:	..... [meter draw down]
* circle or complete the correct answer		

Data sheet 3.3. Water source (to be completed by technician).

Because every water source or aquifer has a limited recharge capacity, its capacity should be recorded together with the corresponding lowering of the groundwater level, if available.

To enable a proper assessment of longer-term developments and the use of the water additional information is required that does not refer directly to the pumping system but may provide a framework for explanation of certain aspects. Information on the following items may therefore be useful and added into the logbook.

- Quality of the water
  - . Salt contents (taste!). Include a copy of lab tests, if available.
  - . Temperature.
  - . Presence of solid particles.

- Variations of the water level
  - . What are the normal seasonal variations in water level?
  - . Reasons for these variations.
  - . Long term variations of the water level over the past years, if any. Known or possible causes.
  - . Is the well at times pumped dry?
  - . Does salt content change appreciably if water level drops?
  
- Source construction
  - . Please add a drawing of the source. In case special filters or filter pipes are used, specify their length, diameter, depth and porosity, kind of filter gravel used, etc.
  - . Describe the protection of the well against pollution of different origin, such as spill water return flow into the source, non-hygienic treatment of water carrying equipment, pollution by natural, human or animal waste or contamination of the aquifer by dung pits, latrines etc.

### 3.4. Summary of operating experience

A serious attempt should be made to describe the history of operating and maintenance experience in the logbook, covering, if possible, the past operating years. Any routine inspections and maintenance carried out should be noted, describing the type of maintenance and how frequently it was done.

The history should summarize any breakdowns and repairs to the pumping system. If possible, it should include for each failure its description, the date of occurrence, time that the system was out of service, descriptions of the cause of failure (if known), and of the maintenance action (repair, replacement, or modification) that was carried out.

A note should be made in the logbook as to whether the average water flow rate or the system efficiency may have changed over time from the nominal values supplied by the manufacturer, or as measured when the system was new.

### 3.5. System description wind pumps

Data Sheet 3.4. serves to describe the pumping and storage system. The capacity of the storage tank may be calculated by  $L \times W \times H$  for rectangular tanks or by  $\frac{1}{4}\pi \times D^2 \times H$  for cylindrical tanks. Use the line "Capacity" for deviating shapes.

In addition to Data Sheet 3.4. supply the following information:

- o Make a sketch or drawing of the pumping system. The sketches should indicate the distance above or below a reference ground level of the water intake, the windmill, the mechanical transmission, the pump, the water storage tank (if used) and the water discharge pipe. The sketches should show the dimensions (lengths and diameters) and locations of piping fittings, including valves, tees, elbows, etc.





Initial investments (specify currencies:)					
ITEM	(a) Cost, insurance, freight (CIF) OR: off-works	(b) Import duties, taxes	(c) Handling, storage, overheads etc.	(d) Subsidies	(a+b+c-d) Total
Pump					
Windmill & tower					
Piping/rising main					
Above ground piping					
Pumphouse and works					
Storage tank					
Installation/ site preparation:					
-low skilled labour					
-high skilled labour					
-local transport					
Other					
<b>Total investments</b>	_____	_____	_____	_____	_____

(continued) Data sheet 3.4. System description wind pump (to be completed by technician).

**NOTE:** in case of local manufacture of pump, windmill, etc. one may distinguish where possible between: material, low skilled labor, high skilled labor and overhead cost to enable the different economic calculations as mentioned in Chapter 6 of reference 1.

**NOTE:** if changes in the well construction are needed, because of the choice of this particular technology, the additional costs for well adaptation need to be included. Common costs for the well construction that would also be needed for other technologies are not to be included (see also Chapter 6 of reference 1).

- o Add photographs showing details of the components of the system as mentioned in the previous paragraph.
- o Describe the measurement equipment applied during the tests. Give relevant parameters like make and type, (maximum and minimum) capacity, resolution (smallest unit indicated), accuracy (%) and address of supplier. Indicate the position of the instruments in the drawing of the pumping system mentioned above.
- o Give a listing and the location of available documentation, describing the system, e.g. assembly drawings, instruction books, performance test results, etc..

### 3.6. Description of the site

A detailed map of the surroundings of the wind pump system shall be provided, including location, size and height of any major obstacles like hills, valleys, trees, forests, houses or buildings. Add a series of 8 to 10 photographs taken at the wind pump site in various directions (panoramic view).

Source of wind data  Height of measurements : .....[m] Type, make of equipment : Exposure  Units: [m/s]	<input type="checkbox"/> Meteo Station in ..... <input type="checkbox"/> Other source ..... <input type="checkbox"/> References .....  <input type="checkbox"/> Good <input type="checkbox"/> Remarks ..... .....												
Year 19.. 19.. 19.. 19.. 19.. 1988 Average	J	F	M	A	M	J	J	A	S	O	N	D	Average

Data sheet 3.5. Summary of wind data (to be completed by technician).

Give information on wind and climate conditions including a description of the wind conditions prevailing over the year at the test site. This can be in the form of seasonal probability distributions of wind velocities and directions obtained from meteorological stations, if present. Data on daily fluctuations are also of interest. If wind data are available from a nearby site with similar terrain, these should be added to the logbook, along with the name and location of that site.

Because the form of the data available may vary strongly for different sites, Data Sheet 3.5. serves only as an example on how to summarize available information.

Specify the end-use of the wind pump system:

- Number of people using the system for drinking water.
- Area of land irrigated by the system.
- Number of cattle watered by the system.

## Chapter 4

# SHORT-TERM TESTS

### 4.1. Objectives

The objective of the Short-Term Tests of the windpump system is to obtain curves showing system water pumping rates, energy inputs and outputs, and efficiencies as a function of ten-minute average windspeeds covering the normal range of wind speed expected at the site.

Additional data will be obtained on the performance of the windmill and of the pump. These include rotor speed characteristics as a function of windspeed and load, and water pumping rate as a function of rotor speed.

### 4.2. Test Protocol

#### 4.2.1. Data collection prior to the start of the tests

Before the short-term tests are begun, the data collection described in Chapter 3 should be completed.

#### 4.2.2. Pretest inspection and preparations:

The following inspections should be carried out prior to field tests. The results should be included as comments in narrative form in the logbook, with notations as to which component or part was inspected and the results of the inspection. If a component listed below is not inspected, that fact should be noted. However, unless the system is not in operating order, do not carry out any maintenance at this time based on the pretest inspections.

Inspect the windmill rotor, the transmission and the pump assembly visually. Determine the condition of the blades, shaft and bearings, both those used for transmitting power and for yawing. Note changes from the original form or spacing of the blades. Comment on the visible wear of all the moving parts including bearings and transmission gears. Note whether lubrication appears adequate.

Observe the windmill during operation. Note whether the rotor turns freely in its bearings and whether it turns easily with the changes in the wind direction. Note excessive vibration of windmill shaft or transmission, if any, while the rotor is rotating.

Listen to the pump during operation. Note if the system does not appear to be in satisfactory physical condition (e.g. look for excessive corrosion, lack of lubrication, lubricant leaks, worn seals) or if the system performance during operation appears to be clearly unsatisfactory (e.g. very low water flow rate, excessive leaks, excessive pump vibrations, noises).

Inspect system piping and valves visually. With the windpump furled, open and close all valves. Note valves which do not operate. Note on a sketch the location and severity of leaks in valves and piping, if any. Also where possible, note the physical condition of the interior surfaces of piping and valves. Determine whether a build-up of scale or other deposits has formed that reduces the effective diameter of the pipe or that causes the interior surface to be extremely rough. Note where the wall thickness has been reduced significantly by corrosion.

**Note:** Following inspection of the valves, it should be determined that all of the valves leading to and from the pump are set in their open position prior to beginning the tests.

Inspect the storage tank if included in the system. Note any leak. Clean the sight glass if present.

Inspect the water intake. Examine screens if they are accessible and note their condition, i.e. whether they are intact or have visible holes, whether they are clogged, etc.

Install test equipment as described in Section 2.2. and ensure that the equipment is calibrated and functioning properly. Enter in the logbook a description of the test equipment used.

For bore hole wells, measure the static suction head (vertical distance from the water level in the borehole to the pump inlet when no water is being pumped and the pump has been off for at least two hours).

#### 4.2.3. Pumping performance

The pumping performance tests will consist of sets of measurements taken during ten minute time intervals. It is recommended to take the sets of measurements as a continuous series. The measurements then just reduce to recording every 10 minutes the readings of the various instruments. Accuracy will greatly improve when the integrating instruments (time, wind speed, flow and stroke/revolution counter) are read in the same order every time.

Data Sheet 4.1. (column "MEASUREMENTS") gives a layout to be used for noting down the results of the measurements and an example of how to fill in the sheet. When the ten-minute measurements are consecutive, the end of a measurement coincides with the beginning of the next one (see lines 0 to 6). Single measurements need two lines in the sheet (see lines 10 and 11). After every interruption a new measurement or block of measurements requires a new "0"-line (see lines 0, 10 and 13).

A total of 100 sets of ten minute measurements should be taken over a period of several days. If wind conditions warrant, the sets of measurements should cover periods when the wind speed is high as well as periods when the wind speed is low. If the rotor does not rotate at all during a 10-minute period, that period should be omitted.

Engage the rotor and pump early in the morning (just after sunrise) of a day with expected normal wind speed. After the wind speed has become so high that the rotor is turning steadily, take a series of ten-minute measurements as follows:

**SET OF TEN-MINUTE MEASUREMENTS:**

The following constitutes a set of measurements:

Time

Record the time  $t$  (hour, minute, second) of the beginning and end of each ten-minute measurement period.

Windrun

Record the readings (kilometers) of the integrating anemometer (windrun meter)  $R_w$  at the beginning and at the end of each ten-minute measuring period.

Water volume pumped

Record the readings (cubic meters) of the integrating flow meter  $Q_B$  at the beginning and at the end of each ten-minute measuring period.

Rotor rotations

Record the readings (revolutions) of the integrating rotation counter attached to the rotor  $N_r$  at the beginning and the end of each ten-minute measuring period.

Pump strokes

(Only as an alternative for rotor rotations; Pump strokes and rotor rotations are related by the transmission ratio).

For reciprocating pumps, record the readings (number of strokes) of the integrating stroke counter  $N_s$  at the beginning and the end of each ten-minute measuring period.

Suction head

Record the reading (meters) of the suction head  $H_{in}$  at the beginning of each ten-minute period.

**Note:** If the pump is below the water surface in the well the suction head should be recorded as a negative number. See Figure 5.1. and the discussion on head measurements on page 27.

Discharge head

Record the reading (meters) of the pressure gauge at the pump discharge  $H_{dis}$  at the beginning of each ten-minute period. During Short-Term Tests the discharge head is defined as the head the pump "sees", including pipeline friction losses (see Chapter 6).

**Note:** Not all pressure gauges read in meters. Other possibilities are bar, At (atmosphere), psi (pound per square inch) and kPa (kiloPascal). The following conversion factors should be used:

Pressure		equivalent head
1 bar	→	10 (m)
1 at	→	10 (m)
1 psi	→	0.69 (m)
1 kPa	→	0.1 (m)

Location:		Date :		[YY/MM/DD]							
District:		Start time :		[HH:MM:SS]							
Owner :		End time :		[HH:MM:SS]							
Pressure head $H_p$ : / [m]				Rotor Diameter: 8 [m]							
MEASUREMENTS (see section 4.4.2.)						CALCULATIONS (see section 4.4.2. and 4.4.3.)					
No	Time	Wind run	Water meter reading	Rotor rotations *)	Suction Head	Discharge Head	Length of period	Average Wind speed	Flow rate	Rotational speed **)	Perform. factor
	[HH:MM:SS]	$R_w$ [km]	$Q_p$ [m <sup>3</sup> ]	$N_R$ or $N_S$ [-]	$H_{in}$ [m]	$H_{dis}$ [m]	T [seconds]	$V_T$ [m/s]	$q_{PT}$ [l/s]	$n_{RT}$ or $n_{ST}$ [rev/s]	$C_p \eta$ [-]
0	7:30:30	156.23	762.31	1829	X	X					
1	7:41:25	158.64	762.57	2165	4.4	31.5	655	3.68	0.40	0.51	0.091
2	7:51:05	160.56	762.77	2424	4.3	31.5	580	3.31	0.34	0.45	0.108
3	8:00:40	162.53	762.99	2703	4.2	31.5	575	3.43	0.38	0.49	0.108
4	8:10:20	164.69	763.24	3017	4.1	31.5	580	3.72	0.43	0.54	0.095
5	8:20:40	167.14	763.52	3366	4.0	31.5	620	3.95	0.45	0.56	0.083
6	8:31:20	169.58	763.80	3717	3.9	31.5	640	3.81	0.44	0.55	0.089
7											
8											
9											
10	9:20:45	180.22	764.98	5207	X	X	X	X	X	X	X
11	9:31:05	182.34	765.20	5495	3.7	31.5	620	3.42	0.35	0.46	0.099
12											
13	9:50:25	187.39	765.75	6168	X	X	X	X	X	X	X
14	10:00:40	189.72	766.00	6482	3.7	31.5	615	3.79	0.41	0.51	0.084
15	10:11:00	191.95	766.22	6773	3.7	31.5	620	3.60	0.35	0.47	0.085
16	10:20:40	193.74	766.39	6999	3.6	31.5	580	3.09	0.29	0.39	0.111
17	10:31:00	195.92	766.62	7288	3.6	31.5	620	3.52	0.37	0.47	0.095
18	10:40:50	197.81	766.81	7541	3.6	31.5	590	3.20	0.32	0.43	0.109
19	10:51:00	199.70	767.01	7797	3.6	31.5	610	3.10	0.33	0.42	0.123
20	11:00:40	201.39	767.18	8022	3.6	31.5	580	2.91	0.29	0.39	0.132
21	11:10:40	203.00	767.35	8247	3.6	31.5	600	2.68	0.28	0.38	0.164
22	11:20:30	204.70	767.52	8472	3.6	31.5	590	2.88	0.29	0.38	0.135
23	11:30:05	206.41	767.71	8714	3.6	31.5	575	2.97	0.33	0.42	0.140
24	11:40:10	207.88	767.89	8908	3.6	31.5	605	2.43	0.21	0.32	0.167
*) Change into Pump strokes if applicable.						**) Change into pump stroke rate if applicable.					

Data sheet 4.1. Measurements and calculations Short-Term Tests (to be completed by technician).

**Preliminary calculations:**

Length of period T

Calculate the exact length of the "ten-minute period" T. T simply equals the difference in time (seconds) between the start and the end of the measuring period.

**Example:** If the first measurement starts at 7:30:30 and ends at 7:41:25, the length of the period T equals 655 seconds (see lines 0 and 1 of Data Sheet 4.1.).

Average wind speed

Calculate the average windspeed for each ten-minute period:

$$V_T = \frac{1000 \cdot (R_{w,e} - R_{w,b})}{T} \quad (\text{m/s})$$

where:  $R_{w,b}$  is the integrating anemometer reading (kilometers) at the beginning of the measuring period.  
 $R_{w,e}$  is the integrating anemometer reading at the end of the measuring period.  
T is the length of the measuring period.

**Example:** If  $R_{w,b} = 162.53$  (km) and  $R_{w,e} = 164.69$  (km), the average wind speed is  $V_T = 3.72$  (m/s) (see lines 3 and 4 in Data Sheet 4.1.).

Average water flow rate

Calculate the average water flow rate for each ten-minute period:

$$Q_{PT} = \frac{1000 \cdot (Q_{P,e} - Q_{P,b})}{T} \quad (\text{l/s})$$

where:  $Q_{P,b}$  is the integrating flow meter reading (cubic meters) at the beginning of each ten-minute period.  
 $Q_{P,e}$  is the integrating flow meter reading at the end of each ten-minute period.  
T is the length of the measuring period.  
1000 is the conversion factor (liters per cubic meter)

**Example:** If  $Q_{P,b} = 764.98$  (m<sup>3</sup>) and  $Q_{P,e} = 765.20$  (m<sup>3</sup>), then the average flow rate is  $Q_{PT} = 0.35$  (l/s) (see lines 10 and 11 in Data Sheet 4.1.).

Average rotational rotor speed

Calculate the average rotational speed of the windmill rotor for each ten-minute period:

$$n_{RT} = \frac{N_{R,e} - N_{R,b}}{T} \quad (\text{revs/s})$$

where:  $N_{R,b}$  is the integrating rotation counter reading at the beginning of the measuring period.  
 $N_{R,e}$  is the integrating rotation counter reading at the end of the measuring period.  
T is the length of the measuring period.

**Example:** If  $N_{Rb} = 6773$  (-) and  $N_{Re} = 6999$  (-), then the average rotational speed  $n_{RT} = 0.39$  (rev/s) (see lines 15 and 16 in Data Sheet 4.1.).

Average stroke rate (optional)

Calculate the average stroke rate  $n_{ST}$  of the reciprocating pump for each ten-minute period:

$$n_{ST} = \frac{N_{Se} - N_{Sb}}{T} \quad (\text{strokes/s})$$

where:  $N_{Sb}$  is the integrating stroke counter reading at the beginning of the measuring period.  
 $N_{Se}$  is the integrating stroke counter reading at the end of the measuring period.  
 $T$  is the length of the measuring period.

Average effective plunger capacity (optional)

Calculate the average effective plunger capacity of the reciprocating pump:

$$PC = \frac{q_{PT}}{n_{ST}} \quad (\text{liter/stroke})$$

### 4.3. Data Reduction

Data reduction will make use of the results of the preliminary calculations to arrive at estimates of the overall performance of the windmill system which can be compared to what would be expected based on the manufacturer's information or to earlier or later data.

The data reduction will consist of the preparation of the following curves based on the experimental measurements:

#### Water Output Curve

For each of the ten-minute measurement sets, plot the average water flow rate  $q_{BT}$  along the vertical axis versus the average wind speed  $V_T$  along the horizontal axis. Figure 4.1. gives an example.



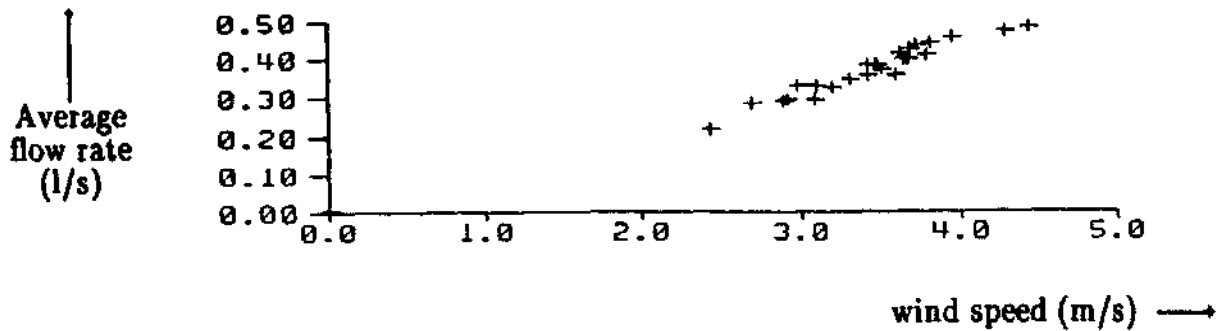

Figure 4.1. Example of water output curve

### Rotor Rotational Speed Curve

For each of the 10-minute measurement sets taken with the rotor engaged, plot the average rotational speed  $n_{RT}$  of the windmill rotor along the vertical axis versus the average wind speed  $V_T$  along the horizontal axis. Figure 4.2. gives an example.

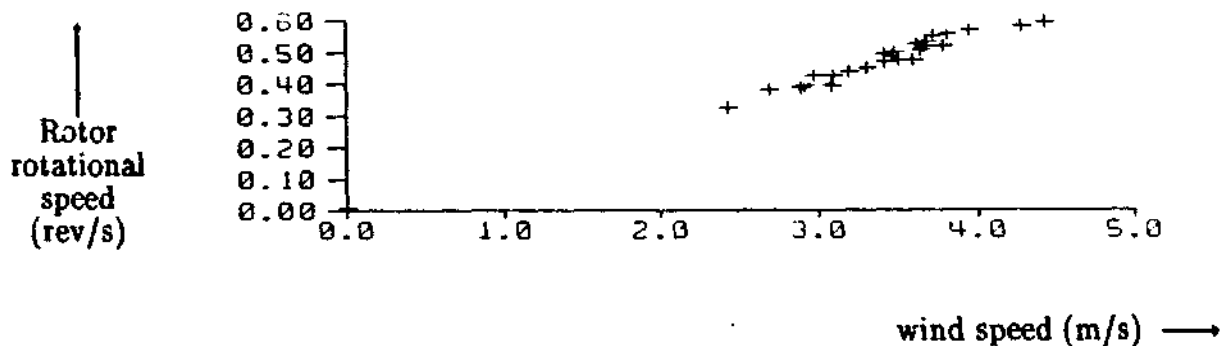

Figure 4.2. Example of rotor rotational speed curve.

### Hydraulic power output curve

For each of the ten-minute measurements sets, calculate the hydraulic power output  $P_{h,T}$  from  $q_{PT}$ ,  $H_{in}$  and  $H_{dis}$  using the following equation:

$$P_{h,T} = 9.81 \cdot q_{PT} \cdot (H_{in} + H_{dis}) \quad (\text{Watt})$$

where: 9.81 is the acceleration due to gravity.

**Example:** If  $q_{PT} = 0.29$  (l/s) and  $H_{in}$  and  $H_{dis}$  are 3.6 (m) and 31.5 (m) respectively, then  $P_{h,T} = 99.9$  (Watt) (see line 20 of Data Sheet 4.1.; result not recorded).

Plot the hydraulic power output  $P_{h,T}$  as calculated for each ten-minute measurement along the vertical axis versus the average wind speed  $V_T$  along the horizontal axis.

### Power input

For each of the ten-minute measurements sets, calculate the power input  $P_{i,T}$  using the following equation:

$$P_{i,T} = 0.393 \cdot \rho_a \cdot D^2 \cdot V_T^3 \quad (\text{Watt})$$

where:  $0.393$  is conversion factor equalling  $\pi/8$ ,  
 $D$  is rotor diameter (m),  
 $V_T$  is average wind speed (m/s),  
 $\rho_a$  is density of air, obtained from the table below.

**Example:** If  $D = 8$  (m),  $V_T = 2.91$  (m/s) and  $\rho_a = 1.23$  ( $\text{m}^3/\text{kg}$ ), then  $P_{i,T} = 762$  (Watt)  
 (see line 20 of Data Sheet 4.1.; result not recorded).

Altitude above sea level (m)	Air density $\rho_a$ ( $\text{kg}/\text{m}^3$ )		
	15°C	25°C	30°C
0	1.23	1.18	1.15
1000	1.09	1.05	1.02
2000	0.96	0.93	0.90
3000	0.85	0.82	0.79
4000	0.75	0.72	0.70
5000	0.65	0.63	0.6

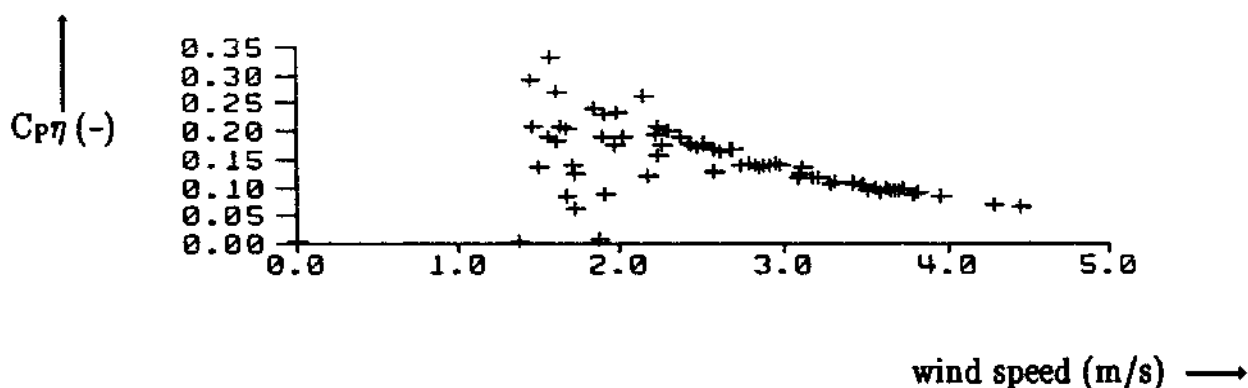

Figure 4.3. Example of overall windpump performance factor curve.

### Overall windpump performance factor curve

For each of the ten-minute measurement sets, calculate the overall windpump performance factor  $C_{P\eta}$  from the following equation:

$$C_{P\eta} = \frac{P_{h,T}}{P_{i,T}} \quad (-)$$

where:  $P_{h,T}$  is hydraulic power output,  
 $P_{i,T}$  is power input, both as calculated above.

**Example:** If  $P_{h,T} = 99.9$  (Watt) and  $P_{i,T} = 762$  (Watt), then  $C_{P\eta} = 0.13$  (see line 20 of Data Sheet 4.1).

Plot the wind pump performance factor  $C_{P\eta}$  for each ten-minute measurement set along the vertical axis versus the average wind speed  $V_T$  along the horizontal axis. Figure 4.3. gives an example. The large scatter in the region with average wind speeds between 1.2 and 2.8 (m/s) is caused by the so-called hysteresis effect; Within this range of wind speeds a running wind pump will continue to run and a not-running wind pump will not start.

## Chapter 5

### LONG-TERM TESTS

#### 5.1. The "System" during Long-Term Tests

During the Long-Term Tests the system under observation includes the following parts:

- |                              |   |  |
|------------------------------|---|--|
| 1. Windmill                  | } | Technical system as considered during Short-Term Test. |
| 2. Transmission              |   |  |
| 3. Pump                      |   |  |
| 4. Storage tank, if any      |   |  |
| 5. Back-up system, if any    |   |  |
| 6. Resources: - Manpower     |   |  |
| - Water                      |   |  |
| - Wind                       |   |  |
| - Money                      |   |  |
| 7. Output: - (Useful) water. |   |  |

In most cases a back-up system, if any, consists of a diesel pump or a hand pump. According to the considerations in Chapter 1 it might be subjected to a Long-Term Test simultaneously. See reference 1 for test procedures for other pumping techniques.

#### 5.2. Measurements and data collection during Long-Term Tests

##### 5.2.1. Measurements

Measurement equipment required and recommendations with respect to its installation have been described in Section 2.2.

Within the framework of Long-Term Testing measurements shall be performed on a regular basis. The maximum period of time allowed between two measurements depends on the capacity of the storage tank that usually is part of a windpump system. The time between two successive measurements should be about equal to the time during which the end-use system can function without major problems when it starts with a storage tank full of water, while no further water is being pumped during that period. Given the most common storage tank sizes for the various applications for irrigation purposes usually a period of one week between the measurements is sufficient. For drinking water systems this period will vary between one day and half a week.

It is recommended to choose fixed times in the week to carry out the measurements; by doing so their regular performance is guaranteed and the chance of forgetting measurements is minimized. Possible schemes could be for an irrigation system every Monday morning, for a drinking water system every Tuesday and Friday at noon, etc.

Location: _____		Start Date : <u>07/01/03</u> [YY/MM/DD]									
District: _____		End Date : <u>07/07/04</u> [YY/MM/DD]									
Owner : _____											
Discharge head H <sub>dis</sub> : <u>37</u> [m]   Pressure head H <sub>p</sub> : <u>/</u> [m]   Horizontal distance L : <u>/</u> [m]   Rotor Diameter: <u>5.10</u> [m]											
MEASUREMENTS (see section 5.4.2.1)					CALCULATIONS (see section 5.4.3.)						
No	Date and time t [YY/MM/DD;HH]	Wind run R <sub>w</sub> [km]	Volume pumped Q <sub>p</sub> [m <sup>3</sup> ]	Volume used Q <sub>u</sub> [m <sup>3</sup> ]	Suction Head H <sub>in</sub> [m]	Length of period T [hours]	Average Wind speed V <sub>T</sub> [m/s]	Volume pumped Q <sub>PT</sub> [m <sup>3</sup> ]	Volume used Q <sub>UT</sub> [m <sup>3</sup> ]	Exploitation factor f <sub>we</sub> [-]	Quality factor e [-]
0	<u>07/01/03:11</u>	<u>20836</u>	<u>1680</u>	<u>93753</u>	<u>2.00</u>						
1	<u>10:08</u>	<u>23925</u>	<u>2018</u>	<u>94054</u>	<u>2.50</u>	<u>165</u>	<u>5.2</u>	<u>338</u>	<u>301</u>	<u>0.89</u>	<u>0.07</u>
2	<u>12:14</u>	<u>26332</u>	<u>2326</u>	<u>94334</u>	<u>1.75</u>	<u>174</u>	<u>4.8</u>	<u>308</u>	<u>280</u>	<u>0.91</u>	<u>0.08</u>
3	<u>24:10</u>	<u>29647</u>	<u>2616</u>	<u>94634</u>	<u>3.25</u>	<u>164</u>	<u>4.6</u>	<u>290</u>	<u>300</u>	<u>1.03</u>	<u>0.09</u>
4	<u>31:18</u>	<u>32879</u>	<u>2956</u>	<u>94909</u>	<u>2.25</u>	<u>176</u>	<u>5.1</u>	<u>340</u>	<u>275</u>	<u>0.81</u>	<u>0.07</u>
5	<u>07/02/03:12</u>	<u>35153</u>	<u>3158</u>	<u>95109</u>	<u>2.00</u>	<u>162</u>	<u>3.9</u>	<u>192</u>	<u>200</u>	<u>1.04</u>	<u>0.10</u>
6	<u>14:15</u>	<u>37123</u>	<u>3282</u>	<u>95274</u>	<u>3.00</u>	<u>171</u>	<u>3.2</u>	<u>134</u>	<u>165</u>	<u>1.23</u>	<u>0.12</u>
7	<u>21:10</u>	<u>39236</u>	<u>2464</u>	<u>95434</u>	<u>3.25</u>	<u>163</u>	<u>3.6</u>	<u>182</u>	<u>160</u>	<u>0.88</u>	<u>0.12</u>
8	<u>28:10</u>	<u>41836</u>	<u>3714</u>	<u>95667</u>	<u>2.00</u>	<u>168</u>	<u>4.3</u>	<u>250</u>	<u>233</u>	<u>0.93</u>	<u>0.10</u>
9	<u>07/03/03:12</u>	<u>44345</u>	<u>3944</u>	<u>95879</u>	<u>2.25</u>	<u>170</u>	<u>4.1</u>	<u>230</u>	<u>312</u>	<u>0.92</u>	<u>0.10</u>
10	<u>14:13</u>	<u>46597</u>	<u>4124</u>	<u>96054</u>	<u>3.00</u>	<u>168</u>	<u>3.7</u>	<u>180</u>	<u>175</u>	<u>0.97</u>	<u>0.11</u>
11	<u>21:11</u>	<u>48091</u>	<u>4184</u>	<u>96110</u>	<u>4.00</u>	<u>166</u>	<u>2.5</u>	<u>60</u>	<u>56</u>	<u>0.93</u>	<u>0.12</u>
12	<u>28:09</u>	<u>49444</u>	<u>4249</u>	<u>96113</u>	<u>4.50</u>	<u>166</u>	<u>2.6</u>	<u>65</u>	<u>3</u>	<u>0.03</u>	<u>0.12</u>
13	<u>07/04/04:12</u>	<u>51553</u>	<u>4376</u>	<u>96117</u>	<u>4.50</u>	<u>171</u>	<u>3.1</u>	<u>127</u>	<u>4</u>	<u>0.03</u>	<u>0.13</u>
14	<u>11:14</u>	<u>52960</u>	<u>4418</u>	<u>96150</u>	<u>4.50</u>	<u>170</u>	<u>2.3</u>	<u>42</u>	<u>33</u>	<u>0.79</u>	<u>0.11</u>
15	<u>18:16</u>	<u>54613</u>	<u>4482</u>	<u>96208</u>	<u>4.25</u>	<u>170</u>	<u>2.7</u>	<u>64</u>	<u>58</u>	<u>0.91</u>	<u>0.10</u>
16	<u>25:12</u>	<u>56089</u>	<u>4542</u>	<u>96262</u>	<u>4.00</u>	<u>164</u>	<u>2.5</u>	<u>60</u>	<u>54</u>	<u>0.90</u>	<u>0.12</u>
17	<u>07/05/04:11</u>	<u>57712</u>	<u>4610</u>	<u>96332</u>	<u>4.00</u>	<u>167</u>	<u>2.7</u>	<u>68</u>	<u>70</u>	<u>1.03</u>	<u>0.11</u>
18	<u>09:10</u>	<u>59626</u>	<u>4790</u>	<u>96399</u>	<u>4.00</u>	<u>167</u>	<u>3.2</u>	<u>140</u>	<u>67</u>	<u>0.48</u>	<u>0.14</u>
19	<u>16:11</u>	<u>62191</u>	<u>4992</u>	<u>96504</u>	<u>3.50</u>	<u>169</u>	<u>4.2</u>	<u>242</u>	<u>185</u>	<u>0.76</u>	<u>0.10</u>
20	<u>23:11</u>	<u>64610</u>	<u>5213</u>	<u>96751</u>	<u>3.50</u>	<u>168</u>	<u>4.0</u>	<u>221</u>	<u>167</u>	<u>0.76</u>	<u>0.11</u>
21	<u>30:11</u>	<u>66908</u>	<u>5405</u>	<u>96938</u>	<u>3.50</u>	<u>168</u>	<u>3.8</u>	<u>192</u>	<u>187</u>	<u>0.97</u>	<u>0.11</u>
22	<u>07/06/04:14</u>	<u>68410</u>	<u>5436</u>	<u>96996</u>	<u>4.00</u>	<u>171</u>	<u>2.0</u>	<u>31</u>	<u>58</u>	<u>1.87</u>	<u>0.12</u>
23	<u>12:10</u>	<u>69615</u>	<u>5509</u>	<u>97064</u>	<u>4.00</u>	<u>164</u>	<u>2.6</u>	<u>73</u>	<u>68</u>	<u>0.93</u>	<u>0.13</u>
24	<u>20:11</u>	<u>71561</u>	<u>5620</u>	<u>97170</u>	<u>3.75</u>	<u>169</u>	<u>3.1</u>	<u>121</u>	<u>106</u>	<u>0.88</u>	<u>0.12</u>
25	<u>27:10</u>	<u>73665</u>	<u>5790</u>	<u>97323</u>	<u>3.50</u>	<u>167</u>	<u>3.5</u>	<u>160</u>	<u>153</u>	<u>0.96</u>	<u>0.12</u>
26	<u>07/07/04:11</u>	<u>76099</u>	<u>5982</u>	<u>97495</u>	<u>3.50</u>	<u>169</u>	<u>4.0</u>	<u>192</u>	<u>172</u>	<u>0.90</u>	<u>0.09</u>
Monthly/Quarterly/Half-yearly cumulative values:						<u>4368</u>		<u>4302</u>	<u>3742</u>		
Monthly/Quarterly/Half-yearly average values:							<u>3.51</u>			<u>0.87</u>	<u>0.12</u>

Data sheet 5.1. Measurements and calculations Long-Term Tests (to be completed by owner (Measurements) and technician (Calculations)).

Data Sheet 5.1. (column "MEASUREMENTS") gives a layout for noting down the numerical information required and an example of how to fill in the sheet. For every measurement one line on the data sheet is available. At the start of the Long-Term Test the first reading of the various instruments is recorded on the first line (marked by "0"). When during Long-Term Tests a new Data Sheet is opened, the first line is used for copying the last measurement of the previous Data Sheet.

The two bottom lines of Data Sheet 5.1. are used for average and cumulative values over a longer period of time. It is recommended to choose the number of lines in Data Sheet 5.1. in such a way that averages and cumulative values are calculated over a proper period of time i.e. a month, a quarter or half a year. Dependent on the chosen period of time between two successive measurements (see above) the following lengths of Data Sheet 5.1. could be applied:

Time between two successive measurements	Number of lines in Data Sheet 5.4.1	Length of averaging period
1 day	31	month
half a week	26	quarter
1 week	26	half a year

Date and Time

Write Date and Time in the format YY/MM/DD;HH, e.g. 87/01/03;11 is equivalent to 3 January 1987 at 11 a.m. Recording the time in whole hours is sufficiently accurate for the present purpose.

Wind speed (Wind run)

For Long-Term Tests the integrating cup anemometer (wind run meter) shall be used. Write the results in km (kilometers).

Water volume pumped and water volume actually used

During Short-Term Tests for wind pump systems with a storage tank the flow meter was installed at the pump outlet. During Long-Term Tests a second meter (same type) shall be placed at the discharge of the storage tank.

In order to obtain information on the effect of the storage tank, during Long-Term Testing the owner should preferably not switch off the pump when the tank is full. To avoid spillage of water the system should be equipped with an overflow pipe to a place where excess water can be utilized. Do not feed back the excess water to the well; it might contaminate the water source.

By doing so the flow meter between the pump and the tank measures the potential water volume pumped at the given circumstances. The second flow meter measures the water volume actually consumed by the end user or the end-use system. Under certain conditions it might be difficult to require the owner to operate his pumping system continuously, e.g. when the water is scarce. A compromise might be to operate the system continuously during a shorter period of time. Also an indemnification might be offered to the owner to compensate for the extra running hours.

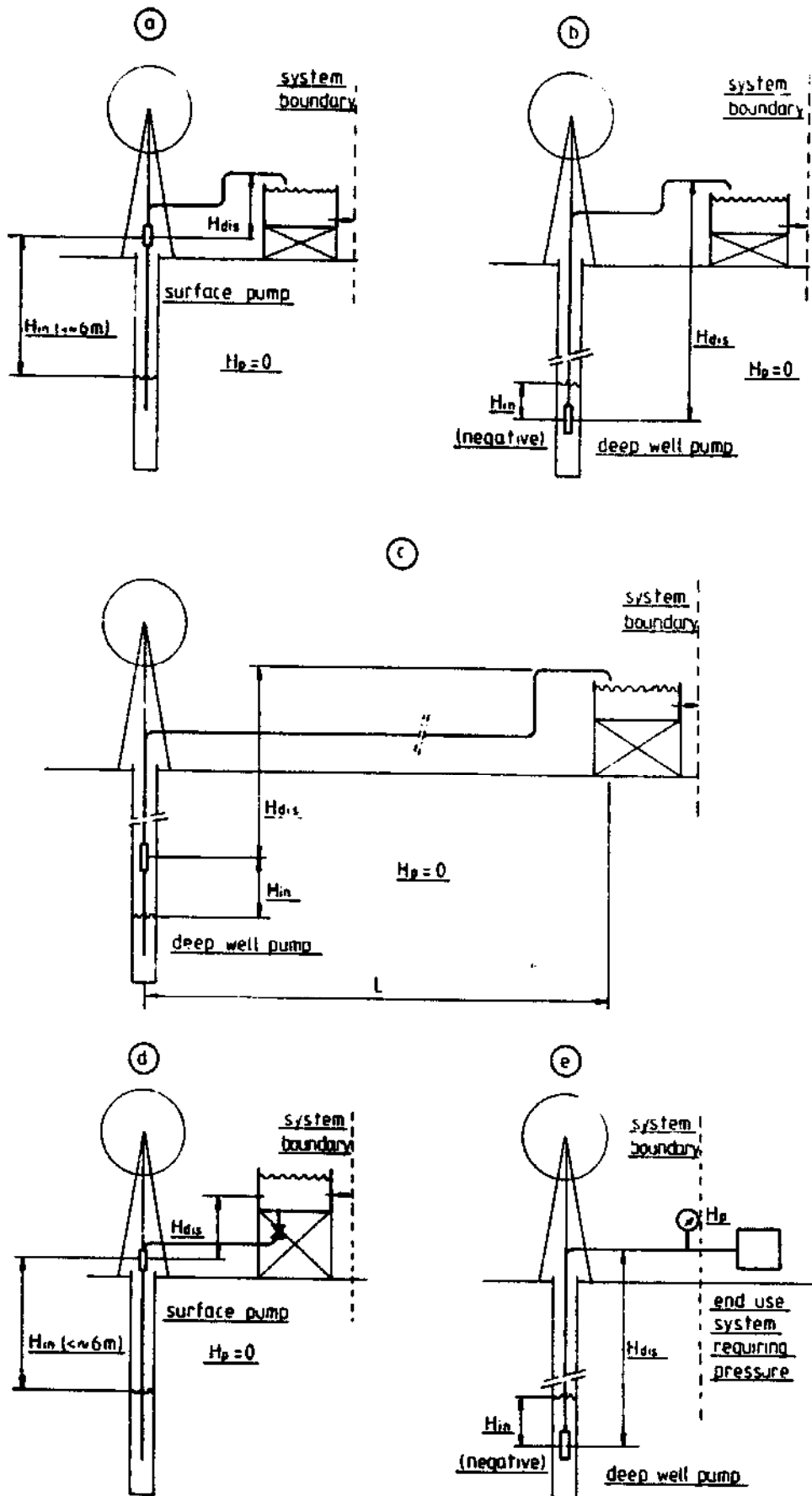

Figure 5.1. Examples of head measurements.

If for any reason only one flow meter is available, it should be installed at the storage tank outlet.

Check the flow meters regularly in order to detect malfunctioning (e.g. due to contamination) as soon as possible (see Section 2.2.). Care should be taken to record whether and when the flow meters passed their maximum number of digits and started at the zero reading again, especially if for any reason readings are taken over longer intervals than prescribed.

The water volume pumped is read from the flow meter between pump and storage tank, the water volume actually used is read from the flow meter at the storage tank outlet. Note the results down in cubic meters ( $m^3$ ).

### Head

#### a. Suction Head

If the level of the water source showed large variations during the Short-Term Tests, the accuracy of the tests may be improved by taking an additional measurement of the suction head  $H_{in}$ , e.g. halfway through the measuring period T. Put all values in the logbook and record the average value (in meters (m)) in Data Sheet 5.1.

#### b. Discharge Head

In many cases the discharge head  $H_{dis}$  is constant. It is simply the vertical distance between the pump and the discharge pipe outlet at the top of the storage tank. If the discharge pipe enters at the bottom of the storage tank, the discharge head should be measured up to the average water level in the tank (e.g. halfway between top and bottom). Write the results in meters (m).

### Pressure Head

In most wind pump applications a storage tank functions as a water tower to generate a pressure head as required for the end use system. Then this pressure simply forms part of the discharge head from pump level to storage tank water level and must not be measured separately. If alternatively for example a wind pump directly feeds a system requiring a pressure at its intake, e.g. a sprinkler system (which is not common practice), the discharge pressure  $H_p$  should be measured at the sprinkler system intake by means of a bourdon type manometer. Write the results in meters (m).

In Figure 5.1. some examples are given to illustrate the measurement of the different types of head for a number of situations:

- Case a. A shallow well is equipped with a surface pump and a storage tank. The suction head  $H_{in}$  is measured from the water level to the center of the pump, the discharge head  $H_{dis}$  from the center of the pump to the end of the pipe above the storage tank. In this case there is no pressure head.
- Case b. A tube well is equipped with a deepwell pump and a storage tank. Because the pump is below the water level,  $H_{in}$  is negative. It should be calculated by the difference between the water level (meters below ground level) and the position of the pump (meters below ground level).
- Case c. A tube well feeds a storage tank at a long distance L. Note L down in the heading of Data Sheet 5.1. The suction head is calculated as in case b. Because the pump is situated above the water level,  $H_{in}$  is now positive.



Case d. The storage tank is fed through its bottom. Therefore  $H_{dia}$  is measured between pump level and the average water level in the tank.

Case e. The pumping system feeds an end use system requiring a pressure. The corresponding pressure head is measured by means of a manometer at the system boundary.

Initials	Function	Name
AB	Owner	Butsi, A
FA	Technician	Abebe, F
PS	Operator	Sanford, P

Date	Init	Description	Down time [hours]	Time spent [hours]	Costs [\$. .]	logbook page
52/04/28	FA	Maintenance	30			26
		Skilled labour		12	60	
		Grease			1	
		Leather cup			2	
		Unskilled labour		24	50	
52/04/30	AB	Operators salary			40	
52/05/01	PS	Windpump Purled				27
52/05/01	PS	Windpump in operation again	18			

Data sheet 5.2. Chronological survey of all relevant events (to be completed by various people).

### 5.2.2. Additional data collection

The logbook should describe in sufficient detail all events occurred e.g. the activities carried out with regard to servicing, maintenance (i.e. preventive actions), repair (i.e. corrective action) and overhaul. It should specify the date of the event, the amount of time spent and the costs (distinguish between skilled and unskilled labor, parts, materials, lubricants and transportation). It is recommended to make this description by systematically treating the following issues:

- Maintenance
  - . Actions performed (by whom?). If standard, refer to users manual.
  - . Replaced parts
  - . Lubricants used
  
- Break downs of the system
  - . Description of system failure
  - . When was it discovered?
  - . Who was warned, how?
  - . (Possible) causes
  - . When was repair started?
  - . Actions performed (by whom, time spent?)
  - . When was the system ready for operation again?
  
- Operation of the system
  - . Periods of intentional furling of the windpump, reasons
  - . Periods of water shortage, reasons
  
- Water source
  - . Occurrence of abnormal water levels in water source.
  - . Well running dry.

Data sheet 5.2. gives a layout and a hypothetical example of how to complete this sheet. It can be used as a summary of all events and simultaneously serve as a table of contents to refer to logbook pages with detailed information. The first lines of Data Sheet 5.2. give information on the people contributing to the logbook. The subsequent columns of the data sheet contain the date of the event, the initials of the reporter (it is very important that any person putting down information in the logbook is identified by his initials; he is an important source of additional information when needed), a short description, the time during which the system was out of order (down time), the time spent on maintenance or other activities, the costs and the page number of the logbook where detailed information, if any, is recorded. The example shows how the different kind of costs can be distinguished by using more lines for a single event.

### 5.3. Data reduction of Long-Term Tests

Data analysis should be initiated as soon as possible after data collection to quickly indicate possible problems with either the pumping system or the data collection instruments.

Early detection of any anomalies in the data will not only lead to more reliable data, but will also eliminate potential problems resulting from incorrect installations of equipment or oversights in the design. Also deterioration of performance in time may be detected by doing so.

If during the Long-Term Tests large deviations from expected values are found, it is recommended to perform (part of) a Short-Term Test in order to identify possible causes of these deviations.

#### 5.3.1. Performance

The results of reduction of data on system performance are recorded in Data Sheet 5.1. in the column indicated by "CALCULATIONS".

Two steps of data reduction are performed, both using essentially the same types of calculations and formulas.

1. After each measurement cumulative and average values are calculated over the period of time between that measurement and the previous one. The length of the period of observation T equals the time between two successive measurements (e.g. 1 day, half a week, 1 week). The calculations are performed using pairs of two successive measurements. The results are noted down in Data sheet 5.1. behind the corresponding measurements.
2. After a certain period of time e.g. a month, a quarter, half a year, a year), when a data sheet is fully completed, cumulative and average values over that longer period are calculated. Now the length of the period of observation T equals the time between the two measurements at the beginning and the end of that period. For the calculations the latter two measurements are used. The results are noted down on the two bottom lines of Data Sheet 5.1. and in Data Sheet 5.3. under the heading "Performance".

#### Length of period T

The length of the period of observation T simply equals the length of time between two measurements.

**Example:** The first measurement took place on 3 January 1987 at 11.00 A.M. (87/01/03;11), the second one on 10 January at 08.00 A.M. (87/01/10;08). The length of the time period T is 7 days minus 3 hours equalling 165 hours (see lines 0 and 1 of Data Sheet 5.1.).

**Average wind speed**

When the wind run meter readings  $R_w$  are registered in km, the average wind speed over a period T is:

$$V_T = \frac{R_{w,e} - R_{w,b}}{3.6 T} \quad (\text{m/s})$$

where:  $R_{w,b}$  is wind run meter reading at the beginning of period T,  
 $R_{w,e}$  is wind run meter reading at the end of period T,  
T is length of observation period in hours,  
3.6 is conversion factor 3600/1000.

**Example:** On 7 February 1987 the wind run meter indicated 35153 km ( $R_{w,b}$ ); a week later the reading was 37123 km ( $R_{w,e}$ ). Then the formula leads to  $V_T = 3.2$  (m/s) (see example in lines 5 and 6 in Data Sheet 5.1.).

**Water volume pumped**

When the flow meter readings  $Q_p$  are registered in  $\text{m}^3$ , the water volume pumped over a period T is:

$$Q_{PT} = Q_{P,e} - Q_{P,b} \quad (\text{m}^3)$$

where:  $Q_{P,b}$  is the reading of the integrating flow meter at the beginning of period T,  
 $Q_{P,e}$  is the reading of the integrating flow meter at the end of period T.

**Example:** On 21 March 1987 the flow meter at the pump outlet indicated 4184  $\text{m}^3$  ( $Q_{P,b}$ ). A week later the reading was 4249  $\text{m}^3$  ( $Q_{P,e}$ ). Application of the formula leads to  $Q_{P,T} = 65 \text{ m}^3$  (see lines 11 and 12 in Data Sheet 5.1.).

**Water volume actually used**

When the flow meter readings  $Q_U$  are registered in  $\text{m}^3$ , the water volume actually used over a period T is:

$$Q_{UT} = Q_{U,e} - Q_{U,b} \quad (\text{m}^3)$$

where:  $Q_{U,b}$  is the reading of the integrating flow meter at the beginning of period T,  
 $Q_{U,e}$  is the reading of the integrating flow meter at the end of period T.

**Hydraulic wind pump output**

The hydraulic system output  $E_{h,T}$  over a period T can be calculated from  $Q_{PT}$  by:

$$E_{h,T} = 2.73 \cdot Q_{PT} \cdot \frac{H_b + H_e}{2} \quad (\text{Wh})$$

where:  $H_b$  is total effective head (see Chapter 6) at the beginning of period T,  
 $H_e$  is total effective head at the end of period T,  
2.73 is conversion factor (9.81x1000/3600).

**Example:** During the week from 9 to 16 May 1987 the hydraulic system output was:

$$E_{h,T} = 2.73 \cdot 242 \cdot \left( \frac{4 + 3.5}{2} + 37 \right) = 26922 \quad (\text{Wh})$$

See lines 18 and 19 of Data Sheet 5.1. (The number 37 stands for the discharge head  $H_{dis}$ , see heading of the Data Sheet).

The result is not recorded in the Data Sheet. It is used in the next calculation:

**Quality factor**

The quality factor e is obtained from the quantities above by:

$$e = \frac{E_{h,T}}{A \cdot V_T^3 \cdot T}$$

where: A is rotor area calculated from the rotor diameter D by:  
 $A = 0.785 \cdot D^2 \quad (\text{m}^2)$   
 $P_{h,T}$  is hydraulic windpump output  
 $V_T$  is average wind speed.

**Example:** During the week from 9 to 16 May 1987 the hydraulic output was 26922 Wh (see previous example). In this period the quality factor equals:

$$e = \frac{26922}{0.785 \cdot (5.18)^2 \cdot 4.2^3 \cdot 169} = 0.1$$

See lines 18 and 19 in Data Sheet 5.1.

**Wind pump exploitation factor**

The wind pump exploitation factor  $f_{we}$  over a period T is calculated by:

$$f_{we} = \frac{Q_{UT}}{Q_{PT}} \quad (-)$$

**Example:** During the week from 7 to 14 February 1987 the water volume pumped was  $Q_{PT} = 134 \text{ m}^3$ . The water volume actually used was  $Q_{UT} = 165 \text{ m}^3$ . As a result  $f_{we}$  equals 1.23. See line 6 of Data Sheet 5.1.

**Average and cumulative values over a longer period of time**

The bottom lines of Data Sheet 5.1. are used for noting down average and cumulative values over a longer period of time. In the example this period has a length of 26 weeks.

The Total length of period T (being 4368 hours in the example) can be obtained by summing all calculated T-values or alternatively by the difference between the first and the last "Date and Time" (lines 0 and 26).

For the Long-term average wind speed, the Total water volume pumped and the Total water volume used the formulas explained in the beginning of this section are applied using the integrating meter readings on line 0 and line 26. The result is:

$$\begin{aligned} \text{Half-yearly average wind speed} &= \frac{76099 - 20836}{3.6 \times 4368} = 3.51 \text{ m/s} \\ \text{Half-yearly water volume pumped} &= 5982 - 1680 = 4302 \text{ m}^3 \\ \text{Half-yearly water volume used} &= 97495 - 93753 = 3742 \text{ m}^3 \end{aligned}$$

The Half-yearly average windpump exploitation factor (in the example being 0.87) results from the quotient of the half-yearly water volume pumped and half-yearly water volume used.

For the Half-yearly average quality factor the half-yearly hydraulic wind pump output  $E_{h,T=\frac{1}{2}y}$  has to be determined:

$$E_{h,T=\frac{1}{2}y} = 2.73 \times Q_{P,T=\frac{1}{2}y} \times H_{\text{average}} \quad (\text{Wh})$$

Where:  $H_{\text{average}}$  is half-yearly average total effective head.  
 $Q_{P,T=\frac{1}{2}y}$  is half-yearly water volume pumped (4302 m<sup>3</sup>),

The last quantity is most accurately calculated when all 27 suction head measurements available in Data Sheet 5.1. are used. The result is:

$$H_{\text{in,average}} = (2.0 + 2.5 + 1.75 + \dots + 3.5)/27 = 3.34 \text{ m.}$$

Because the discharge head is constant (37 m), the average total effective head becomes:

$$H_{\text{average}} = 37 + 3.34 = 40.34 \text{ m.}$$

Using these results the half-yearly hydraulic windpump output is:

$$E_{h,T=\frac{1}{2}y} = 2.73 \times 4302 \times 40.34 = 473,772 \text{ Wh.}$$

Finally the Half-yearly average quality factor is calculated using the formula presented earlier in this section:

$$e_{\frac{1}{2}y} = \frac{E_{h,T=\frac{1}{2}y}}{A \cdot V_T^3 \cdot T}$$

Inserting the average and cumulative values from above the result is:

$$e_{\frac{1}{2}y} = \frac{473,772}{0.785 \times (5.18)^2 \times 3.51^3 \times 4368} = 0.12$$

<b>SUMMARY OVER 19...</b>				
<b>Location :</b> ..... <b>District :</b> ..... <b>Owner :</b> .....				
<b>Performance</b>				
Average wind speed	:	.....		[m/s]
Yearly water volume actually used	:	.....		[m <sup>3</sup> ]
Yearly water volume pumped	:	.....		[m <sup>3</sup> ]
Quality factor	:	.....		[-]
Wind pump exploitation factor	:	.....		[-]
<b>Operation</b>				
Operating time of the system	:	.....		[hours]
Total time needed for maintenance	:	.....		[hours]
Total time needed for repairs	:	.....		[hours]
Total down-time	:	.....		[hours]
Total time "put out of the wind"	:	.....		[hours]
Number of break-downs	:	.....		[-]
Mean down time	:	.....		[hours]
Mean time between failures	:	.....		[hours]
Availability	:	.....		[-]
.....	:	.....		.....
.....	:	.....		.....
.....	:	.....		.....
.....	:	.....		.....
<b>Recurrent Costs (                    )*</b>				
	operation	maintenance	repair	total
Skilled labor	.....	.....	.....	.....
Unskilled labor	.....	.....	.....	.....
Materials,	.....	.....	.....	.....
Parts	.....	.....	.....	.....
Transportation	.....	.....	.....	.....
Replacements	.....	.....	.....	.....
* Indicate currency; note replacement types & time in log				

**Data sheet 5.3. Summary of information of Wind pump System (to be completed by technician).**

**Notes:** 1. The quality factor  $e$  of the wind pump system relates the hydraulic output of the windpump to the energy content of the air flowing through the rotor over a longer period of time. For "classical design" windpumps the quality factor varies between 0.08 and 0.11. For modern design windpumps its value lies between 0.10 and 0.15. A measured quality factor of a wind pump system much lower than previously measured or lower than expected based on information supplied by the windpump builder or vendor might be caused by:

- a low volumetric efficiency of the pump
  - . a worn leather cup,
  - . worn valves,
- a problem in the windmill
  - . deformation of blades,
  - . defect in control mechanism,
- a dry well.
- a sub-optimal matching of the system (too small or too large a pump).

2. The windpump exploitation factor  $f_{we}$  relates the water volume pumped to the water volume actually used. Its maximum value is 1.00<sup>1</sup>, which means that all water pumped is usefully applied. A high value of  $f_{we}$  is important; when it is halved, the cost of the water is doubled. Low values of  $f_{we}$  might be caused by such factors as:

- too large a windpump
- too small a storage tank
- low water requirements in a windy period
- a leak in the storage tank.

The average and cumulative data over the period of a year (to be calculated as described above) should be put in Data Sheet 5.3. under the heading "Performance".

### 5.3.2. Reliability of the wind pump system

As stated, Data Sheet 5.2. shows information on reliability e.g. the number of system failures, their type and duration, repair types and times, maintenance problems, climatological or natural phenomena affecting delivery reliability, any inherent design faults, etc.

In Data Sheet 5.3. this information will be summarized for a period of a year under the heading "Operation". Some items are already suggested in the sheet.

The various total times asked for might require some explanation. Operating time is the time during which the system was running during the length of period T. Total time needed for maintenance and total time needed for repair equal the number of man hours spent on maintenance and repair respectively. Total down-time is the total time the system was not in operating order due to system failures. Total time "put out of the wind" is the total time during which the windpump has been intentionally put out of operation.

---

<sup>1</sup> As shown in the example (line 6 of Data sheet 5.1., the value of  $f_{we}$  might be higher than 1 over shorter periods of time. The effect is caused by the storage tank that can "produce" water even if there is no new water input at all.



The reliability of the system can be expressed by three different indicators. These are the mean down time (MDT), the mean time between failures (MTBF) and the availability. They are calculated as follows:

$$\text{MDT} = \frac{\text{Total down-time}}{\text{number of break-downs}} \quad (\text{hours per break-down})$$

$$\text{MTBF} = \frac{\text{Length of period} - \text{Total down-time}}{\text{number of break-downs}} \quad (\text{hours})$$

$$\text{Availability} = \frac{\text{Length of period} - \text{Total down-time}}{\text{Length of period}} \quad (-)$$

These indicators all refer to different aspects of reliability. E.g. if a short MTBF is caused by many break-downs of short duration (due to quick repair service), the MDT is low and the availability of the system is high.

In addition other events could be summarized, for instance those having occurred strikingly often (e.g. pumping dry of the well). Careful consideration of Data Sheet 5.2. should result in meaningful summaries of events.

### 5.3.3. Recurrent costs

The data on recurrent costs collected during the Long-Term Test, recorded in Data Sheet 5.2., will be summarized in Data Sheet 5.3. under the heading "Recurrent Costs". Details on types and times of repairs will be noted down in the log.

## Chapter 6

# TOTAL EFFECTIVE HEAD

For the Long-Term Tests described in this Handbook the total effective head  $H$  is an important notion. It stands for the useful head over which the water volume pumped is transferred by the pump. It is used to calculate the useful hydraulic system output  $P_{h,T}$ . Basically it consists of four components, some of which may be zero under certain conditions:

$$H = H_{in} + H_{dis} + H_{hor} + H_p \quad (m)$$

where:  $H_{in}$  is suction head  
 $H_{dis}$  is discharge head  
 $H_{hor}$  is equivalent head for horizontal transport  
 $H_p$  is pressure head required at the boundary of the pumping system.

The suction head is the vertical distance that the water must be lifted in travelling from the water level of the water source to the pump.

The discharge head<sup>2</sup> is the vertical distance that the water must be lifted in travelling from the pump to the end of the discharge pipe.

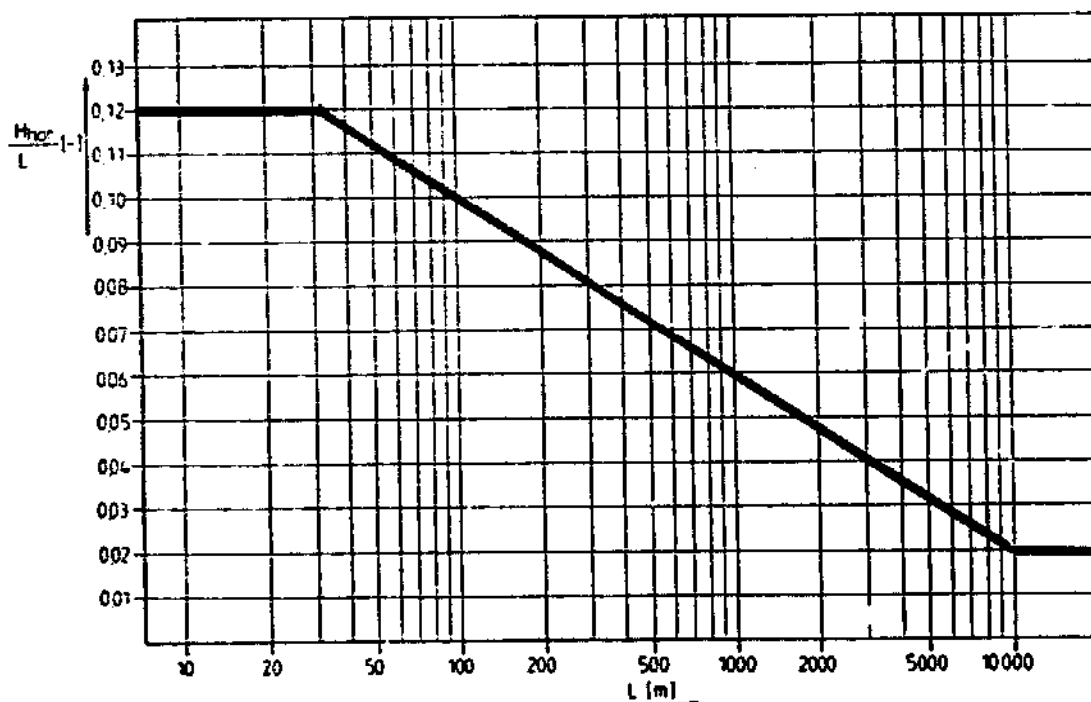

Figure 6.1. Equivalent head for horizontal transport as a function of the distance  $L$ .

<sup>2</sup> This definition of discharge head holds for Long-Term Testing only. For Short-Term Testing, where only the pumping system is considered, the discharge head simply is defined as the head "seen" by the pump.

The equivalent head for horizontal transport is a term to reward the function of the system when water is transported over (long) horizontal distances. It is recommended to use Figure 6.1. for determining  $H_{hor}$ , starting from  $L$  being the distance along which the water is transported horizontally. The curve in Figure 6.1. has been derived as an average of properly designed water pumping systems. It is based on the following assumptions:

- Average flow velocities in pipes between 1 and 2 m/s.
- For long horizontal distances optimal values of the average flow velocity are lower than for short distances.
- The optimal average flow velocity increases with the pipe diameter.

**Example:** If the horizontal distance  $L$  equals 100 m, the factor  $H_{hor}/L = 0.1$  (see Figure 6.1.). As a result, the equivalent head for horizontal transport  $H_{hor}$  equals  $100 \times 0.1 = 10$  m.

If the horizontal distance  $L$  is longer, e.g. 10,000 m, the factor  $H_{hor}/L = 0.02$ . Now  $H_{hor} = 10,000 \times 0.02 = 200$  meters.

The pressure head required at the boundary of the pumping system is the head required for example to operate a sprinkler installation.

The total effective head  $H$  is used to calculate the hydraulic power output of the pumping system  $P_{h,T}$

$$P_{h,T} = Q_{PT} \cdot \rho_w \cdot g \cdot H \quad (\text{Wattseconds})$$

where:  $Q_{PT}$  is water volume pumped ( $m^3$ )  
 $\rho_w$  is density of water ( $kg/m^3$ ),  
 $g$  is acceleration due to gravity ( $m/s^2$ ).

This hydraulic power output of the system is used to calculate the overall system efficiency  $\eta_{tot}$ :

$$\eta_{tot} = \frac{P_{h,T}}{P_{i,T}} \quad (-)$$

where:  $P_i$  is the measured power input to the pumping system.

The function of a pumping system to be rewarded is transport of water to a higher head, to a higher pressure and/or over a certain horizontal distance. This function is quantified by the total effective head as defined above. It rewards a vertical lift ( $H_{in}$  and  $H_{dis}$ ), a horizontal transport in terms of a reasonable friction head ( $H_{hor}$ ) and a pressure at the pumping system boundary ( $H_p$ ). If a system is badly designed, e.g. by having high internal friction losses, the measured power input to the system  $P_{i,T}$  will be high. As a result the overall system efficiency  $\eta_{tot}$  will be low for such a system.

If a storage tank functions as a water tower to generate the discharge pressure required by the end-use system, this pressure is included in the discharge head from pump level to storage tank water level and must not be measured separately. If alternatively a windpump directly feeds a system requiring pressure, the discharge pressure should be measured at the intake of that system by means of a simple manometer.

## References

1. **USAID, CIDA, DGIS, GTZ, FAO**  
**Handbook for comparative evaluation of technical and economic performance of water pumping systems.**  
**Edited by CWD, Amersfoort, October 1988**

## Figure 1.4. Worldwide Wind Energy Resource Distribution Estimates

NOTE: The map follows page 274.

### Description of Map

This map is a preliminary estimate of the annual mean wind energy available at typical well-exposed locations throughout the world. The average energy in the wind flowing in the layer near the ground is expressed as a wind energy class. The greater the average wind energy, the higher the wind energy class, and the darker the shade of green on the map. The colors corresponding to classes of wind energy are defined in the table at the upper right.

The wind energy class is defined in relation to the mean wind energy flux (WEF) at 50 meters above ground level. The WEF is the rate of flow of wind energy through a unit vertical cross-sectional area perpendicular to the wind direction. At 10 meters, the WEF estimate represents large areas that are relatively free of obstructions. Local terrain features can cause the mean wind energy to vary considerably over short distances, especially in coastal, hilly, and mountainous areas. There will be local areas of higher or lower wind energy than can be shown on a worldwide map.

### Background Information

The relation between the mean WEF and the mean wind speed in the table at the upper right assumes a Rayleigh Distribution (Weibull with  $k=2$ ) for the wind speed frequency distribution. A  $1/7$  power law for mean wind speed and a  $3/7$  power law for mean WEF relates the 50-meter estimates to the 10-meter estimates.

Because the wind energy estimate generally applies to typical well-exposed locations, the fraction of the land area represented by the wind energy class depends on the physical characteristics of the land-surface form in the region. For example, on a flat open plain close to 100 percent of the area will have a similar wind energy class, while in hilly and mountainous areas the wind energy class will apply only to a small proportion of the area that is well exposed. On the map, areas where mountainous relief generally exceeds 1500 meters are shown using lines with tick marks. Within these areas wind resource estimates are for exposed ridge crests.

The mean wind energy may vary considerably with time of year and time of day. Thus regions with the lowest wind energy class may have considerably higher wind energy during part of the year or day, or both. Conversely, regions with the highest wind energy may experience considerably lower mean wind energy during part of the year. Only a few areas of the world have persistently high wind energy year round.

Vast areas of the world have little or no wind data, and there is disturbingly little data from exposed sites in many windy regions of the world. Of the large amount of wind data available from specific areas at the time of preparation of the map, only a small proportion of the stations had information on anemometer height above ground level or on site exposure. Thus regional climatological information, upper air wind data, and other appropriate information, where available, were used in the assessment.

# Distributors of World Bank Publications

**ARGENTINA**  
Carlos Hirsch, SRL  
Calle San Geronimo  
Florida 165, 4th Floor-Ciudad 453/465  
1333 Buenos Aires

**AUSTRALIA, PAPUA NEW GUINEA,  
FIJI, SOLOMON ISLANDS,  
VANUATU, AND WESTERN SAMOA**  
D.A. Books & Journals  
11-13 Station Street  
Melbourne 3132  
Victoria

**AUSTRIA**  
Gardl and Co.  
Grieh 31  
A-1011 Wien

**BAHRAIN**  
Bahrain Research and Consultancy  
Association Ltd.  
P.O. Box 22103  
Manama Town 317

**BANGLADESH**  
Micro Industries Development  
Assistance Society (MIDAS)  
House 56, Road 7A  
Dharmoadi R/Arin  
Dhaka 1209

**BELGIUM**  
Publications des Nations Unies  
Av. du Roi 202  
1040 Brussels

**BRAZIL**  
Publicacoes Tecnicas Internacionais  
Lda  
Rua Pinheiro Gomes, 209  
01409 Sao Paulo, SP

**CANADA**  
Le DeFenseur  
C.P. 85, 1501 B rue Aspire  
Boucherville, Quebec  
J4B 5B6

**CHINA**  
China Financial & Economic Publishing  
House  
4, Da Po Si Dong Jie  
Beijing

**COLOMBIA**  
Editorial Ltda  
Apartado Aereo 34270  
Bogota D.E.

**COSTA RICA**  
Libreria Trejos  
Calle 11-17  
Av. Fernandez Guardia  
San Jose

**COTE D'IVOIRE**  
Centre d'Édition et de Diffusion  
Africain (CEDA)  
01 B.P. 541  
Abidjan 04 Plateau

**CYPRUS**  
MEMEB Information Services  
P.O. Box 2096  
Nicosia

**DENMARK**  
Samfundslitteratur  
Rennegaards Allé 11  
DK-1970 Frederiksberg C

**DOMINICAN REPUBLIC**  
Ediciones Taller, C. por A.  
Residencia y local en Caibarien 309  
Apartado Postal 2190  
Santo Domingo

**EL SALVADOR**  
Fuentes  
Avançada Manual Borrador Araujo #3520  
Edificio 565A, 1er. Piso  
San Salvador

**EGYPT, ARAB REPUBLIC OF**  
Al Abram  
Al Galaa Street  
Cairo

The Middle East Observer  
8 Chaworth Street  
Cairo

**FINLAND**  
Abolentia Kirjakauppa  
P.O. Box 128  
SF-00101  
Helsinki 10

**FRANCE**  
World Bank Publications  
66, avenue d'Alsace  
75116 Paris

**GERMANY, FEDERAL REPUBLIC OF**  
(GNO Verlag)  
Poppehauer Allee 55  
D-5300 Bonn 1

**GREECE**  
ICME  
34, Apollonios Street Platia Plastiras  
Athens-11435

**GUATEMALA**  
Libreria Piedra Santa  
Centro Cultural Piedra Santa  
11 calle 4-50 zona 1  
Guatemala City

**HONG KONG, MACAO**  
Asia 2000 Ltd.  
4 PL. 146 Prince Edward Road, W.  
Kowloon  
Hong Kong

**HUNGARY**  
Kultur  
P.O. Box 139  
1369 Budapest 62

**INDIA**  
Alind Publishers Private Ltd.  
751 Mount Road  
Madras - 600 002

Branch office:  
15 J.N. Heredia Marg  
Balfour Estate  
Bombay - 400 038

13/14 Anand Ali Road  
New Delhi - 110 002

17 Chittaranjan Avenue  
Calcutta - 700 072

Jaydeva Hostel Building  
5th Main Road, Gandhinagar  
Bangalore - 560 009

3-5-1129 Kachiguda Cross Road  
Hyderabad - 500 027

Poothana Place, 2nd Floor  
Near Thakore Bungalow, Navrangpur  
Ahmedabad - 380 009

Patela House  
16-A Anand Marg  
Lucknow - 226 001

**INDONESIA**  
Pt. Indira Limited  
Jl. Sun Kelatangi 37  
Jakarta Pusat  
P.O. Box 181

**IRELAND**  
TDC Publishers  
12 North Frederick Street  
Dublin 1

**ITALY**  
Libreria Commissionaria Sorrento SPA  
Via Benedetto Fontana, 120/10  
Casella Postale 552  
50125 Florence

**JAPAN**  
Eastern Book Service  
37-3, Hongo 3-Chome, Bunkyo-ku 113  
Tokyo

**KENYA**  
Africa Book Service (S.A.) Ltd  
P.O. Box 45245  
Nairobi

**KOREA, REPUBLIC OF**  
Pan Korea Book Corporation  
P.O. Box 101, Kwangwhamsun  
Seoul

**KUWAIT**  
MEMEB Information Services  
P.O. Box 9465

**MALAYSIA**  
University of Malaya Cooperative  
Bookshop, Limited  
P.O. Box 1127, Jalan Pantai Baru  
Kuala Lumpur

**MEXICO**  
INFOTEC  
Apartado Postal 22-460  
14060 Tlalpan, Mexico D.F.

**MOROCCO**  
Société d'Etudes Marketing Marocaine  
12 rue Mozart, Bd. d'Anfa  
Casablanca

**NETHERLANDS**  
InCo-Publicaties B.V.  
P.O. Box 14  
7240 BA Luchem

**NEW ZEALAND**  
Hills Library and Information Service  
Private Bag  
New Market  
Auckland

**NGERIA**  
University Press Limited  
Three Crowns Building Jericho  
Private Mail Bag 3095  
Ibadan

**NORWAY**  
Norskann Information Center  
Bjørnstad Nærvesvei 2  
P.O. Box 6125 Stensund  
N-0602 Oslo 6

**OMAN**  
MEMEB Information Services  
P.O. Box 1413, Saab Airport  
Muscat

**PAKISTAN**  
Minna Book Agency  
45, Shaikh-e-Qasid-e-Aam  
P.O. Box No. 729  
Lahore 3

**PERU**  
Editorial Deseño SA  
Apartado 3824  
Lima

**PHILIPPINES**  
National Book Store  
701 Rizal Avenue  
P.O. Box 1904  
Metro Manila

**POLAND**  
ORPAN  
Fata: Kultury i Nauki  
00-901 Warszawa

**PORTUGAL**  
Livreria Fornoal  
Rua Do Carmo 70-74  
1200 Lisbon

**SAUDI ARABIA, QATAR**  
Jary Book Store  
P.O. Box 3196  
Riyadh 11471

**MEMEB Information Services**  
Branch office:  
Al Abaa Street  
Al Doha Center  
First Floor  
P.O. Box 7188  
Riyadh

Hajj Abdullah Altrafa Building  
King Khalid Street  
P.O. Box 3840  
Dammam

33, Mohammed Hassan Awad Street  
P.O. Box 5976  
Jeddah

**SINGAPORE, TAIWAN, BURMA,  
BRUNAI**  
Information Publications  
Private, Ltd.  
02-06 1st Fl., Pet-74 Industrial  
Bldg.  
24 New Industrial Road  
Singapore 1953

**SOUTH AFRICA**  
For single titles:  
Oxford University Press Southern  
Africa  
P.O. Box 1141  
Cape Town 8020

For subscription orders:  
International Subscription Service  
P.O. Box 41095  
Craighall  
Johannesburg 2024

**SPAIN**  
Mundi-Press Libros, S.A.  
Castello 37  
28001 Madrid

**SEI LANKA AND THE MALDIVES**  
Lake House Bookshop  
P.O. Box 244  
100, Sir Chittampalam A. Gardiner  
Mawatha  
Colombo 2

**SWEDEN**  
For single titles:  
Fritzes Fackbokforlaget  
Kungälvsgatan 12, Box 10364  
S-100 27 Stockholm

For subscription orders:  
Wennerstrom-Wilhelm AB  
Box 30004  
S-104 25 Stockholm

**SWITZERLAND**  
For single titles:  
Libreria Poyot  
6, rue Geneva  
Case postale 581  
CH 1211 Geneva 11

For subscription orders:  
Libreria Poyot  
Service des Abonnements  
Case postale 3312  
CH 1002 Lausanne

**TANZANIA**  
Oxford University Press  
P.O. Box 5999  
Dar es Salaam

**THAILAND**  
Central Department Store  
316 Silom Road  
Bangkok

**TRINIDAD & TOBAGO, ANTIGUA,  
BARBUDA, BARBADOS,  
DOMINICA, GRENADA, GUYANA,  
JAMAICA, MONTserrat, ST.  
KITTS & NEVIS, ST. LUCIA,  
ST. VINCENT & GRENADINES**  
Systematic Studies Unit  
#9 Water Street  
Curepa  
Tortola, West Indies

**TURKEY**  
Hemur Kitapevi, A.S.  
Ishtlal Caddesi No. 469  
Beyoglu  
Istanbul

**UGANDA**  
Uganda Bookshop  
P.O. Box 7145  
Kampala

**UNITED ARAB EMIRATES**  
MEMEB Gulf Co.  
P.O. Box 6097  
Sharjah

**UNITED KINGDOM**  
Microinfo Ltd.  
P.O. Box 3  
Alton, Hampshire GU34 2PG  
England

**URUGUAY**  
Instituto Nacional del Libro  
San Jose 1116  
Montevideo

**VENEZUELA**  
Libreria del Este  
Aptdo. 40337  
Caracas 1060-A

**YUGOSLAVIA**  
Jugoslavenska Knjiga  
YU-11000 Belgrade Trg. Republike

**ZIMBABWE**  
Longman Zimbabwe  
P.O. Box 51 125, Southerton  
Harare

Mollweide projection.  
Map adapted from original prepared by the Pacific Northwest Laboratory,  
operated for the U.S. Department of Energy by the Battelle Memorial  
Institute  
[GPO 1981 798-274].

Figure

# Worldwide Wind Energy Resources

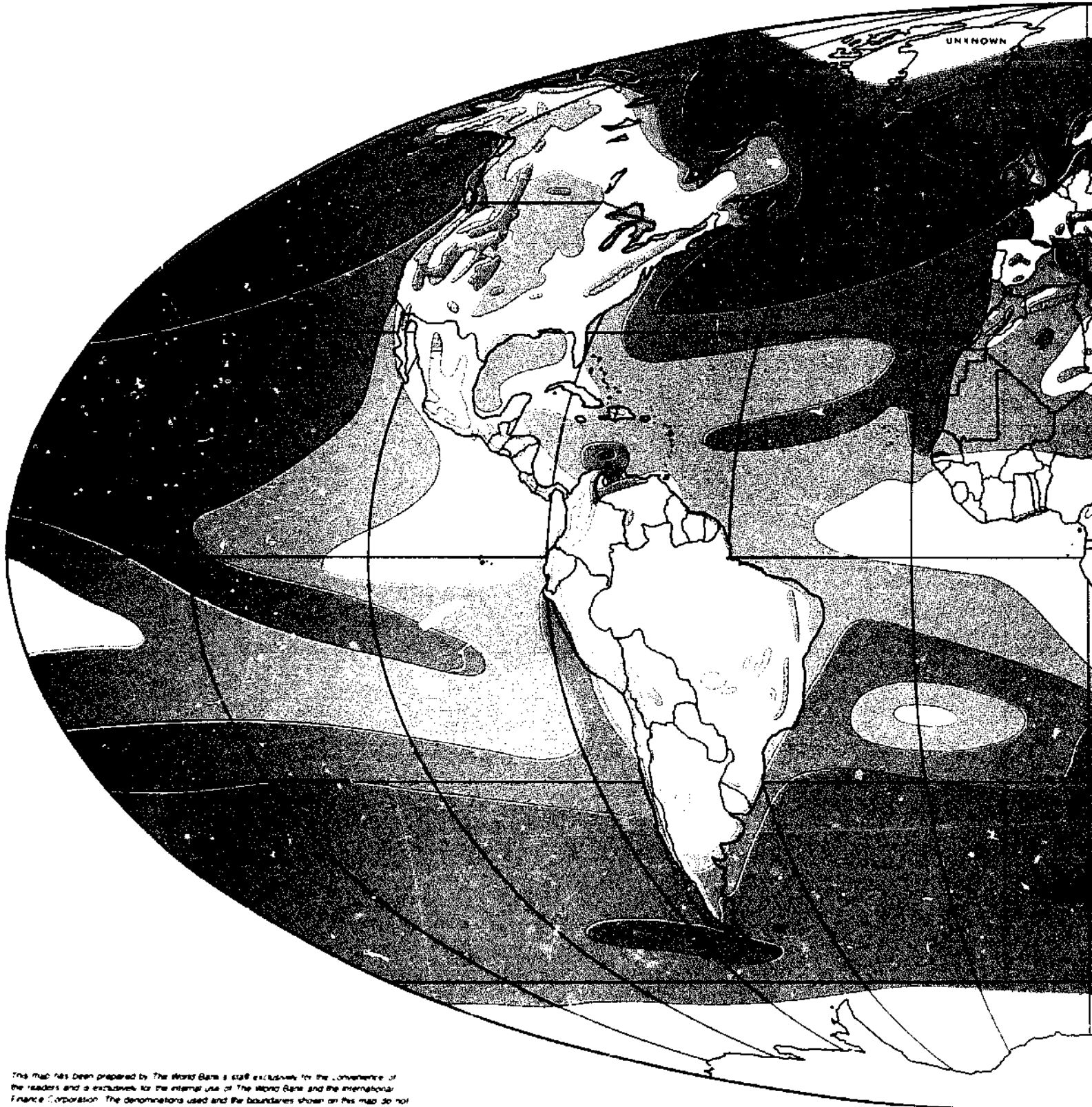

This map has been prepared by The World Bank's staff exclusively for the convenience of the readers and is exclusively for the internal use of The World Bank and the International Finance Corporation. The denominations used and the boundaries shown on this map do not imply on the part of The World Bank and the International Finance Corporation any judgment on the legal status of any territory or any endorsement or acceptance of such boundaries.

# Force Distribution Estimates

## Classes of Wind Energy Flux (WEF)

Wind energy class	10 m. (33ft.)			50 m. (164 ft.)		
	WEF W/sq. m.	Speed m/s	mph	WEF W/sq. m.	Speed m/s	mph
1	0	0	0	0	0	0
2	150	5.1	11.5	300	6.4	14.3
3	250	6.0	13.4	500	7.5	16.8
4	400	7.0	15.7	800	8.8	19.7
5	1200	10.1	22.6	2400	12.7	28.4
	>1600	>11.1	>24.9	>3200	>14.0	>31.3

○ Ridge crest estimates (relief >1500 m.)

