

AT MICROFICHE
REFERENCE
LIBRARY

A project of Volunteers in Asia

Simplified Wind Power Systems for Experimenters

by: Jack Park

Published by:

Helion

Box 445

Brownsville, CA 95919 USA

This publication is out of print in 1983.

Reproduced by permission of Helion.

Reproduction of this microfiche document in any form is subject to the same restrictions as those of the original document.

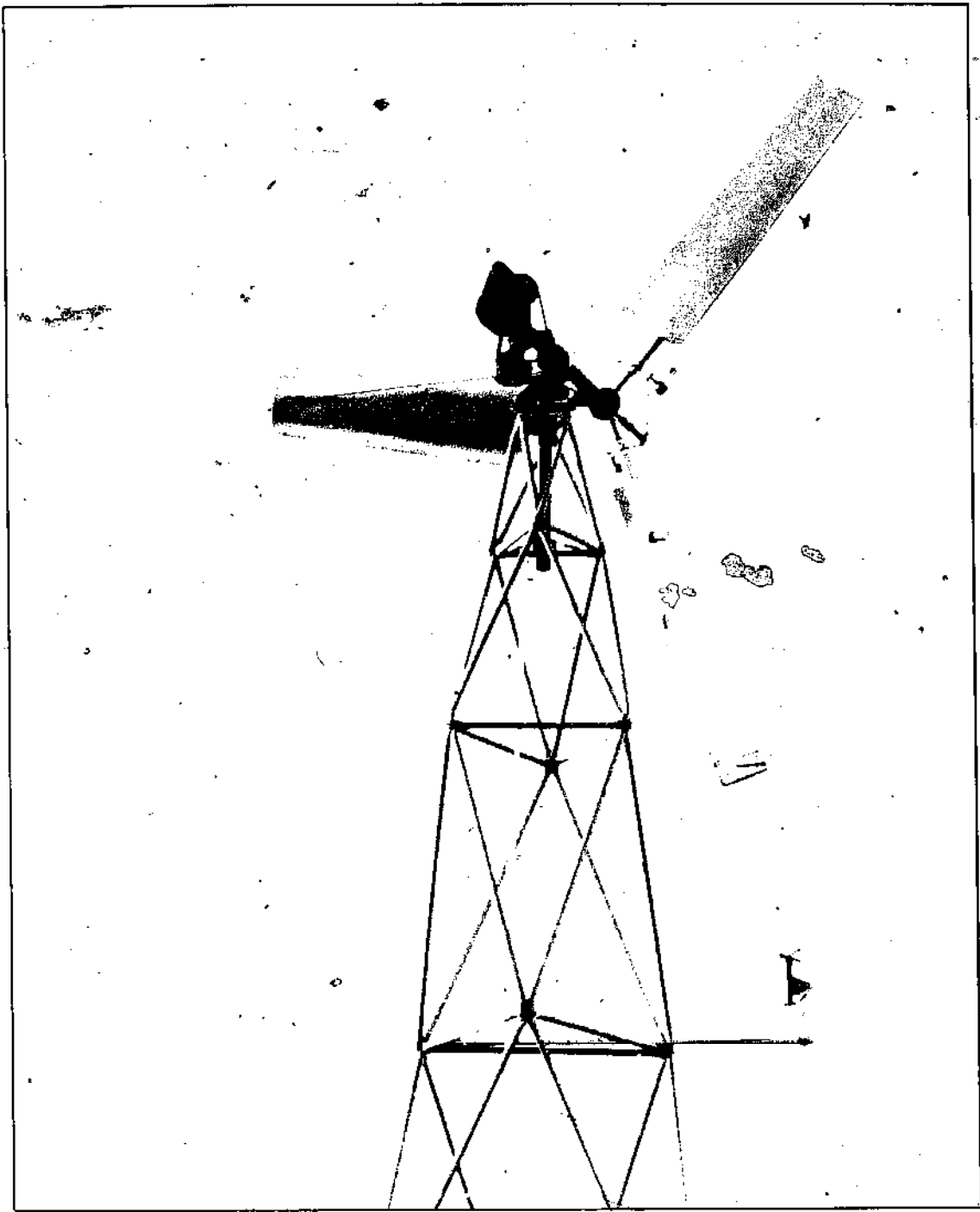

SIMPLIFIED WIND POWER SYSTEMS
FOR EXPERIMENTERS / JACK PARK

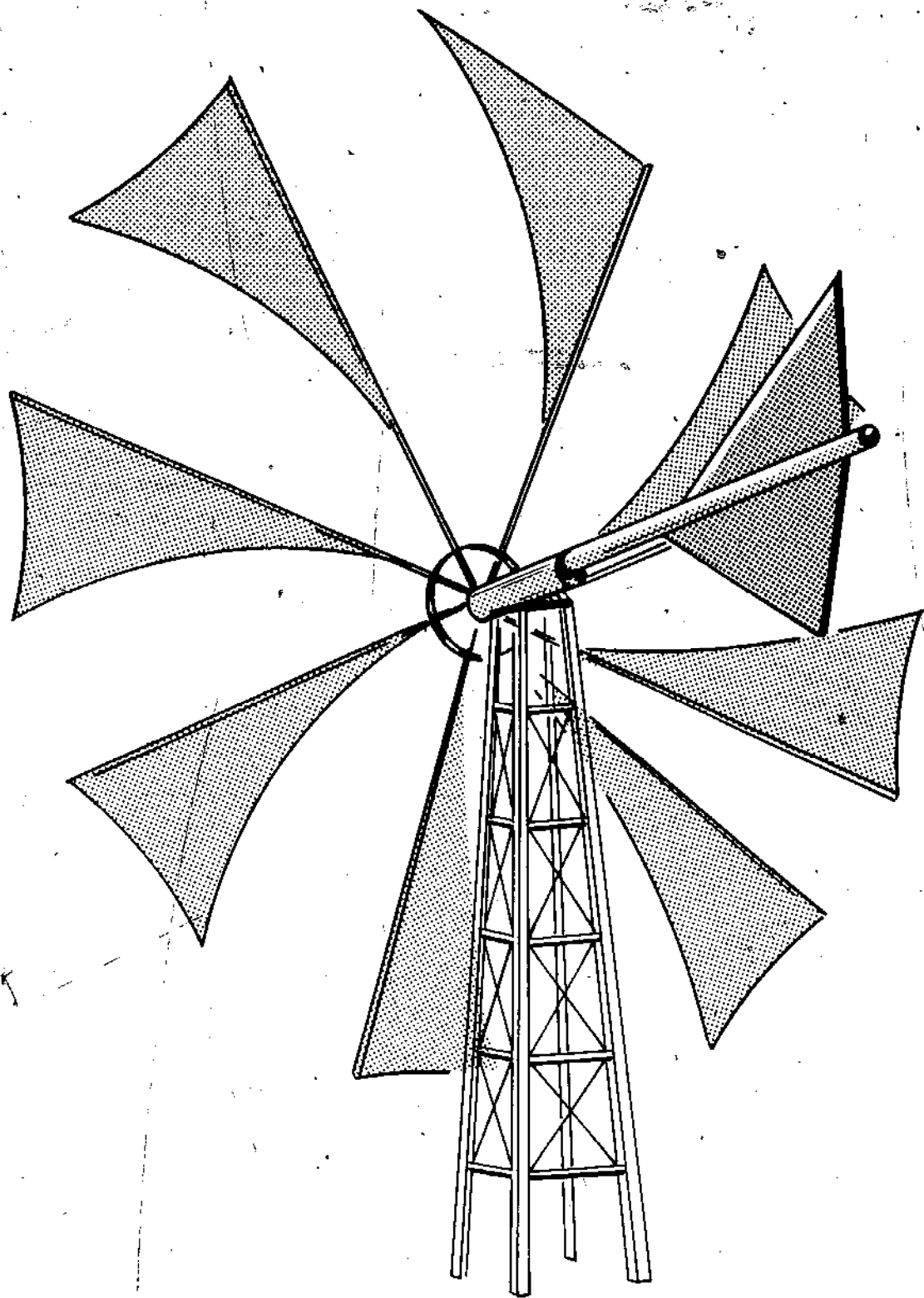

SIMPLIFIED WIND POWER SYSTEMS FOR EXPERIMENTERS

Second Edition

Written by Jack Park

Published by:

HELION • Box 4301, Sylmar, California 91342.

Copies may be purchased from the publisher for \$6 postage paid.

© Copyright 1975 by Jack Park. No portion of this book may be reproduced without the author's written permission.

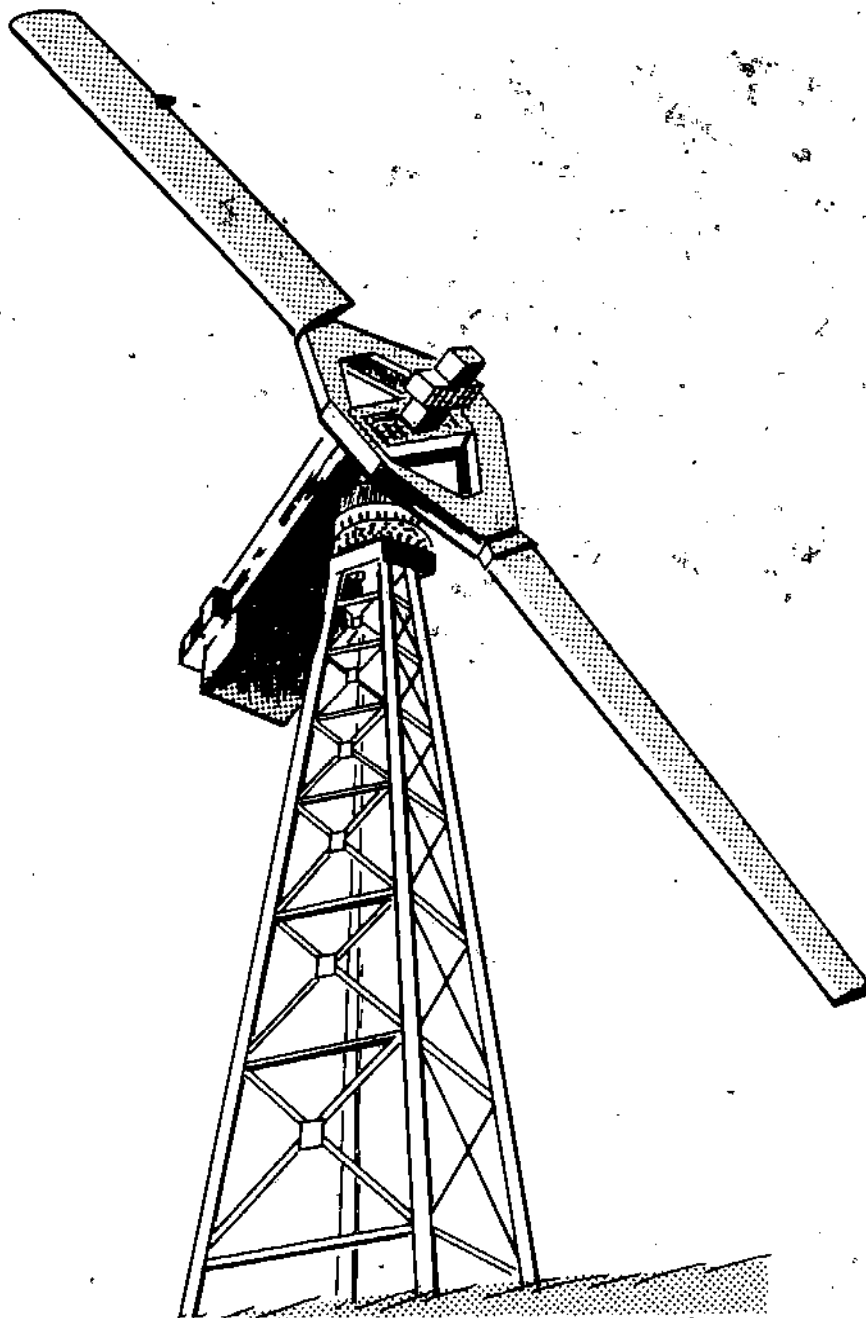

FOREWORD

If you have tried to find information on windmill design methods, if you have designed and built a windmill, if you're merely interested in windmills, by now you have discovered that most of the information available requires engineering training or is not complete enough to satisfy your needs.

This is the second edition of a book written by an engineer who has spent a major portion of his career teaching inexperienced aerospace technicians. This experience has assisted in the writing of this text. It is hoped that the reduction of complex mathematics into simple graphs and arithmetic problems will allow a greater segment of the innovative public to use the fundamentals an engineer has. To make this book as useful as possible, a page has been devoted to graph reading, and numerous examples are used to illustrate each step in the windmill design process. The design approach used is not one of an exact science, but rather one of approximation - taking best guesses and estimates. Numbers may not be exact, but, as with most any design problem, these numbers are usually well within necessary accuracy. Some experimenters will understandably need a few windmills "under their belts" before these calculations become sufficiently accurate. Therefore, the vocabulary used stresses conservative estimation where necessary. The windmills designed from the methods in this manual may be somewhat larger than necessary, but their performance should satisfy the designer's requirements.

One further item: this manual has been, and will be updated, expanded, and improved. The author welcomes all comments and suggestions.

Sylmar, California. 1975

Jack Park

TABLE OF CONTENTS

FOREWORD 2

SECTION A . . . BASIC DESIGN 4

Introduction, The Design Process.

Power Required, The Water Pump, The Electric Power Generator,
Electric Power Required.

Wind Energy Available, Wind Power, Windmill Size.

Windmill Efficiency, Types of Windmills, Vertical Axis Windmills,
Horizontal Axis Windmills, Hybrid Windmills.

SECTION B . . . AERODYNAMIC DESIGN 24

Airfoils, Airfoil Aerodynamics, Windmill Blade Angle Determination,

Hybrid Blade Angles, Airfoil Section, Blade Area Determination

Blade Planform.

Windmill Augmentation.

SECTION C . . . STRUCTURAL AND MECHANICAL DESIGN 38

Structural Design, Centrifugal Force, Windmill Drag, Torque,

Safety Factor, Load Conditions, Blade Strength, Construction

Methods, Tube Spar Design, Fatigue, Structural Design of Vertical
and Hybrid Windmills, Support Structures.

Mechanical Design.

SECTION D . . . POWER SYSTEMS 56

Energy Storage, Storage Batteries, Fuel Cells, Flywheels, Pumped
Water.

Inverters.

BIBLIOGRAPHY 61

APPENDIX A 62

Windmill Data

APPENDIX B 70

Airfoil Data

APPENDIX C 75

How to Read a Graph

APPENDIX D 76

Detailed Windmill Performance

APPENDIX E 77

Strength of Construction Materials

Section A . . . BASIC DESIGN

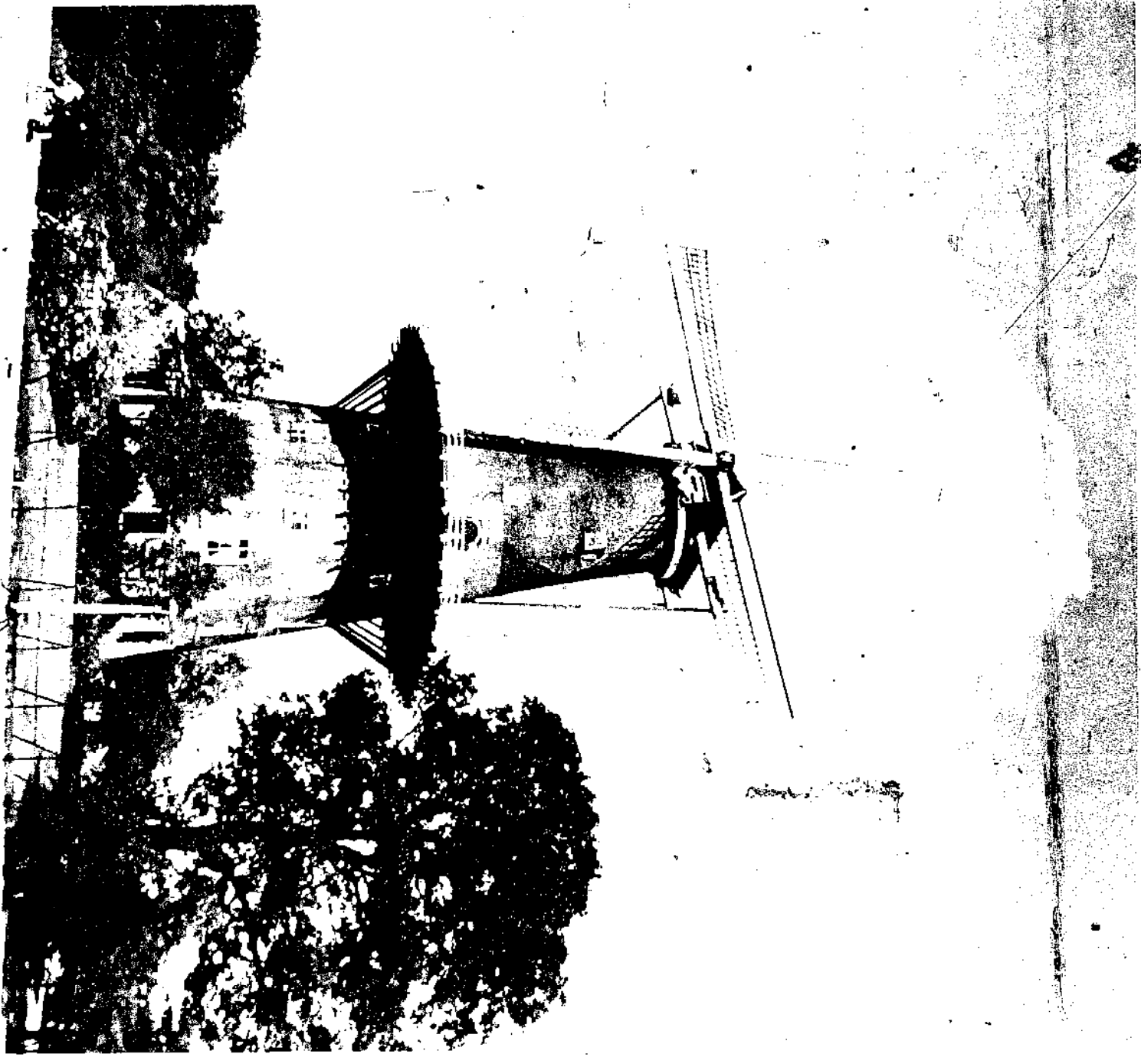

INTRODUCTION

Wind power has been used by man for some 2000 years. Starting with crude sail-type vanes, windmill design progressed through the old Dutch four-blade horizontal axis machines, to very efficient one-, two-, and three-blade high-speed machines which use the latest in high-lift, low-drag airfoils, and light-weight, high strength structural materials. It is now possible for experimentors to use today's advanced technology in the creation of efficient, low cost windmills.

It is the intent of this manual to provide the reader with the engineering tools necessary to accomplish a respectable job of designing and planning the construction of windmills (any type of windmill device). Highly technical discussion of the theoretical aspects of these tools will be neglected in this text, since such material is well documented elsewhere. The engineering tools are merely highly simplified equations and charts with examples of their uses, each reduced so that a person with minimal algebra experience can apply them to his needs.

This manual is written to encourage, or to be a part of, the growing stimulus to experiment and develop power systems at a grass-roots level. It is at this level that the urgency for development is most actively sensed.

Material is presented in building block fashion so that the reader can appreciate the numerous steps involved in the planning of a wind power system. One should understand that the end use of wind power, whether for pumping water or generating electricity or grinding corn, will play a key role in the final shape and size of the device being designed. Other factors in-

clude how much wind is available, where the device will be installed, how much money the builder can muster to complete the project, how complex a system is planned, etc.

THE-DESIGN PROCESS

Basically, the steps one may follow to complete a design exercise are as follows:

1. Determine the power needed.
2. Determine the wind energy available.
3. Determine the configuration and size of windmill required to obtain power required from the energy available.
4. Design the components of the windmill to satisfy aerodynamics and structural requirements.

An alternate design process may be used as follows:

1. Select a type of windmill and size which you feel capable of building.
2. Assume, estimate, or otherwise determine a wind speed for the design.
3. Design the components of the windmill to satisfy aerodynamic and structural requirements.

Where we go from here, then is to a cookbook for designing and planning a wind powered energy system. First, your energy needs

Perhaps the simplest way to harness wind energy is to use nature's windmill, which grows in most yards - the trees. People are harnessing ocean wave power by tying floats to anchored generators. As the floats bob up and down in the waves, the generator is driven by the attachment cable. You might suppose that a hand-operated water pump can be tied to a swinging tree by a rope and a return spring as illustrated here

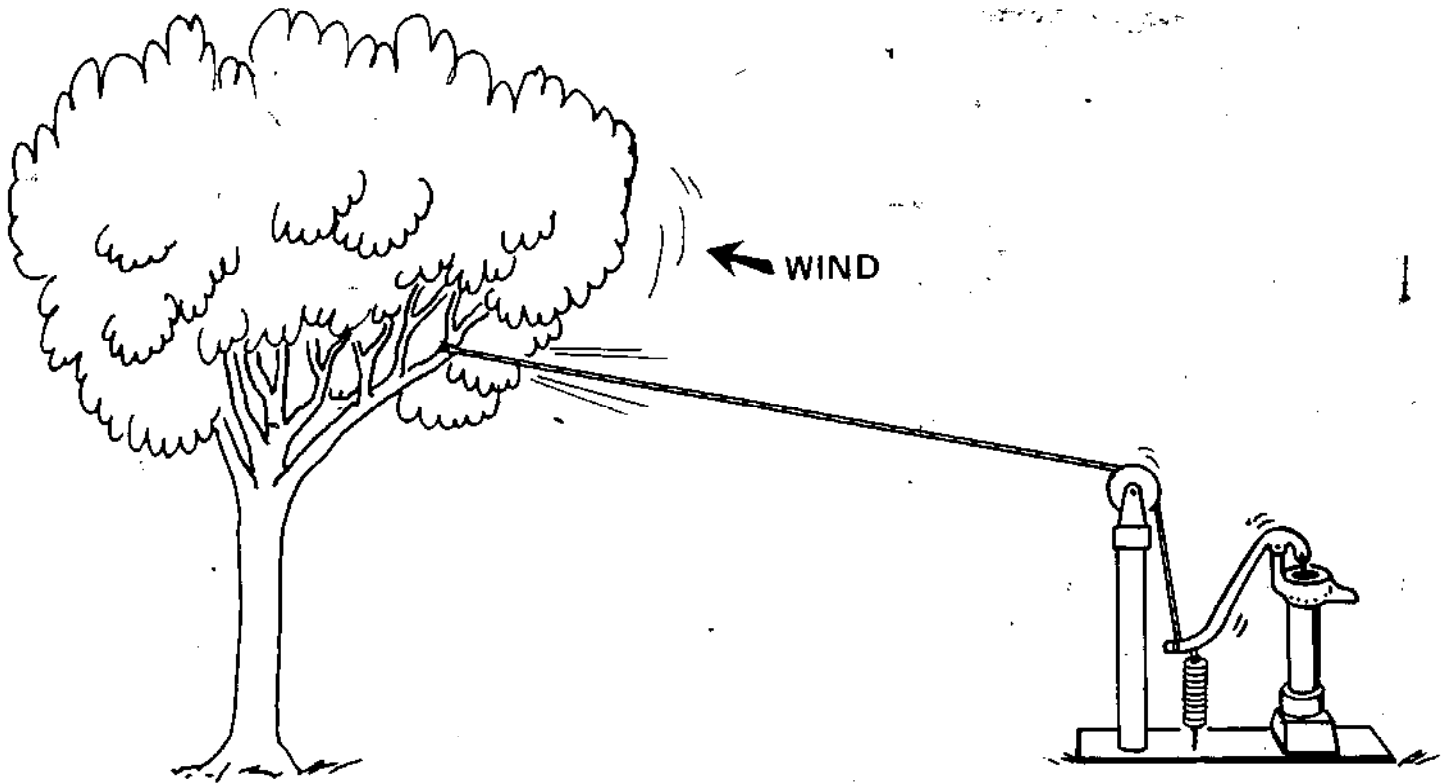

POWER REQUIRED

Let's consider two different end uses for wind power devices. By doing this we can see the basic differences in thinking needed to design these devices. The first use is that of the water pump. You have a well; you wish to use a windmill to pump water up to a tank. The second use will be that of an electric power generator.

One should keep in mind that, in most cases, determination of power required will be a difficult, if not impossible task. In some design cases, however, it may be as simple as looking at last month's electric bill to see how much power was used. In any case, a point which will be made again is that wind energy is basically abundant and relatively easy to convert. One should strive to design a higher power requirement than is calculated in the following section of this book.

THE WATER PUMP

To estimate power needed to pump water, you need to know how high you intend to raise the water, and how fast you intend to raise it. See Figure 1. The result of your calculation will be horsepower required. This is different from horsepower available from the wind. The difference lies in the efficiency, or inefficiency (depending on how you look at it) of all the devices used to do the work. If everything were like the textbooks always say (frictionless perfectly balanced, etc.) power required would be equal to power available. But, this is not the case. Estimate power required to pump water by using CHART A.

EXAMPLE

You intend to pump water from a well 150 feet down to a tank on a 50 foot high hill -thus total height equals 200 feet.

You figure that a flow rate of 400 gallons per hour will tend all needs. Horsepower required is found by locating 200 feet on the horizontal line, then looking up to the 400 gallon per hour line, then across to the vertical line to read horsepower equals 0.94.

Data supplied for commercially available windmill pumps may be used for comparison with power estimates. One should remember that CHART A allows estimation. Conservative windmill design will call for increasing the power requirement estimate by a factor for safety, for eventual growth, or both. A factor like half-again, or even twice the estimate is not unreasonable.

THE ELECTRIC POWER GENERATOR

The designer has a choice of using either a DC or AC system. Automotive applications of electricity are typically DC, while house wiring is AC. If one is planning a small cabin with wind as a primary power source, consideration might be given to the use of DC circuitry with low cost inverters used where AC is required. This allows the use of new or recycled automotive generators or alternators with the windmill. On the other hand, one large (expensive) inverter can convert DC to AC for the entire system.

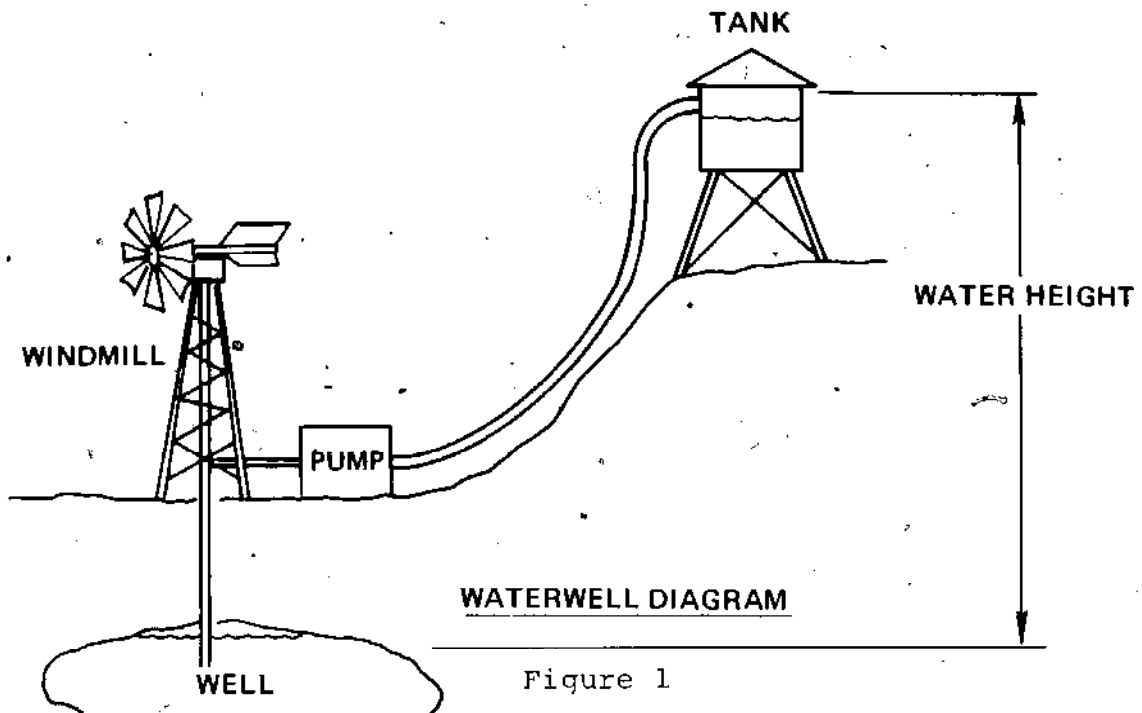
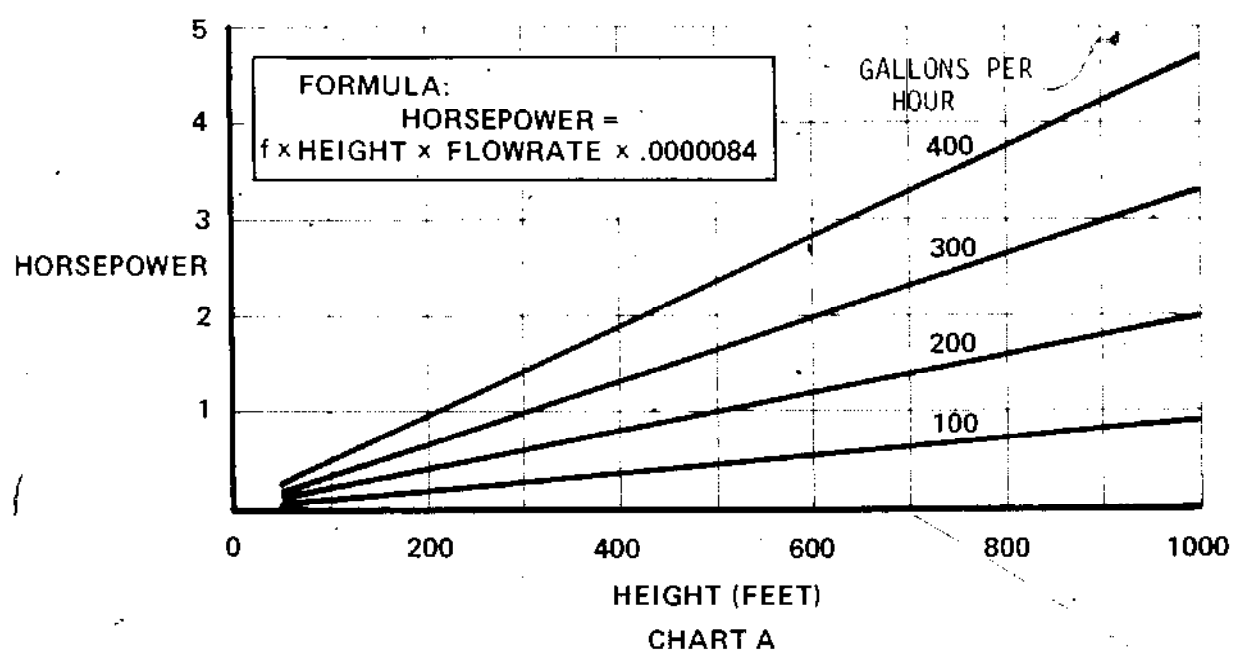

Figure 1

	f=(1.1)	(1.2)	(1.3)	(1.4)	
FLOW RATE	100	200	300	400	
HEIGHT	50	.05	.10	.16	.24
	100	.09	.20	.33	.47
	200	.18	.40	.66	.94
	400	.36	.80	1.3	1.9
	600	.54	1.2	1.9	2.8
	800	.72	1.6	2.6	3.8
	1000	.90	2.0	3.3	4.7



If a designer should choose to install an AC generator on the windmill, the design problem becomes complicated since AC current is held to a 60 hertz frequency (hertz is a unit of AC frequency - commonly known as cycles per second). Electric motors in refrigerators and in clocks require this frequency to be constant. But, wind speed tends to change, which means that windmills driving AC generators must be designed to hold a constant rotational speed (which determines the frequency of the AC generator) over a range of wind speeds, with generator cut-off when wind speed is outside the design range. Simplified design tends to indicate the use of a DC generator, with AC conversion by electronic inverters where necessary.

Electrical power required will not always (usually never) equal wind energy available. From this it is evident that some form of energy storage system is required - like batteries. An entire section of this manual discusses energy storage. It follows, however, that some form of decision must be made as to how much power should be generated in relation to how much is needed. For this, consider first the maximum continuous electrical power needed; then, for how long it's needed.

ELECTRIC POWER REQUIRED

Electric power required is a problem in two parts: how much, and for how long - both parts being equally important.

1. How much - simply add up the known, or expected loads. The units of load will be watts or kilowatts (1000 watts). The load goes beyond just counting up all

the, say, 100-watt light bulbs you plan to turn on with the wind power. The wiring between light bulbs and electrical generator uses up some power. For small installations, where the generator and load are near each other, line loss will add about 3% to the energy requirement. Consult an electrical Code Book, or an electrical contractor for answers to questions on specific installations. Inverters can be counted on to add about 25% to the load. The generator itself may be counted as part of the load and will, due to its own inefficiency, add as much as 50% more to the load. Again, just add up the loads. Use the following handy chart, (from a DWP brochure) for rapid estimation.

APPLIANCE	Average Wattage	Estimated KWH Consumed Per Month
Air Conditioner (Window)	1,325	110
Bed Covering (Automatic)	190	11
Broiler	1,560	8
Clock	2	2
Clothes Dryer	4,350	70
Coffee Maker (Automatic)	850	8
Deep Fat Fryer	1,440	8
Dishwasher	1,180	29
Fan (Attic)	365	27
Fan (Circulating)	85	4
Food Blender	290	1
Food Freezer (Standard, 15 cu. ft.)	350	88
Food Freezer (Frostless, 15 cu. ft.)	440	127
Food Waste Disposer	400	2
Frying Pan (Automatic)	1,160	16
Grill (Sandwich)	1,180	3
Hair Dryer	260	1
Heat Lamp (Infrared)	250	1
Iron (Hand)	1,085	12
Iron (Mangle)	1,500	13
Radio	75	7
Radio-Phonograph	115	9
Range	12,000	100
Refrigerator (Standard, 12 cu. ft.)	265	71
Refrigerator (Frostless, 12 cu. ft.)	295	79
Refrigerator-Freezer (Standard, 14 cu. ft.)	290	100
Refrigerator-Freezer (Frostless, 14 cu. ft.)	435	131
Roaster	1,325	17
Television (Black & White)	255	30
Television (Color)	315	38
Toaster	1,130	3
Vacuum Cleaner	700	3
Portable Heater	1,200	100
Washing Machine (Automatic)	600	7
Washing Machine (Non-Automatic)	280	5
Water Heater	4,500	323

A 100-Watt light bulb burning 10 hours uses 1 KWH of electricity

*(Based mainly on national averages)

EXAMPLE

For a small cabin installation with AC wiring and utilities, the following loads are estimated:

Lights	500 watts
Refrigerator	300 watts
Miscellaneous	250 watts
Total	1050 watts

Accounting for line loss:

$$1.03 \times 1050 = 1082 \text{ watts}$$

Accounting for inverter:

$$1.25 \times 1082 = 1353 \text{ watts}$$

Accounting for generator:

$$1.50 \times 1353 = 2030 \text{ watts} = \text{total load.}$$

The final value doesn't account for the fact that the 300 watt motor in the refrigerator requires 3 to 6 times as much power for a few seconds each time it is started. We assume that this extra load will be handled by our batteries (energy storage). The 2030 watts, then, equals the load for which we might design a windmill. Provision for future growth capabilities can be made by designing, say, to twice this value.

2. How long -we have just determined the maximum continuous load. One would not expect all lights, refrigerator, and other objects to be operating together all the time. Therefore, a practical check on windmill designs requires estimation of the watt-hours or kilowatt-hours that will be needed. If, in the above example the maximum continuous load were applied continuously for an entire 24-hour day, the watt-hour requirement would be $24 \times 2030 = 48,720$ which equals 48.7 kilowatt hours. If the windmill generates 2030 watts for 12 hours the power available would be 24.4 kilowatt-

hours, half of the required power even though the generator is capable of the required watts. The key lies in the duration of the wind. It follows, then, that watt-hours, or kilowatt-hours, is the major factor in designing a windmill.

EXAMPLE

A cabin with a maximum continuous load of 2.5 kilowatts is estimated to require this power for 50% of a day, or 12 hours. The wind averages a certain speed for 4 hours per day (averaged over a period of, say, a week). The problem, then, is to calculate how much power the windmill must be designed for.

Calculate kilowatt-hours:

$$2.5 \times 12 = 30$$

Calculate windmill power required

$$\frac{30 \text{ kilowatt-hours}}{4 \text{ hours}} = 7.5 \text{ kilowatts}$$

This example illustrates the relationship between the duration and the total power actually produced by a windmill. Since only 2.5 kilowatts are needed at any given time, and the windmill generates 7.5 kilowatts when it is windy, the extra power generated will be stored in batteries until such time as it is not windy and the power is still needed.

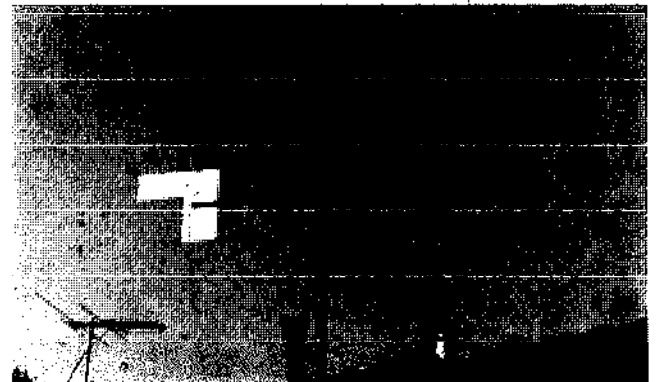

Owner-built wind generator

WIND ENERGY AVAILABLE

To develop a common ground of thought, we should consider the obvious, namely, that the geographic area in which the wind device is to be installed should be given to neither too little, nor too much wind. Too little wind, and the required amount of power is difficult to get, while too much wind may break apart your hand-made device and deposit each component thereof about the countryside. We shall discuss these extremes shortly, but for now let's assume enough wind. Consider, first, why you are designing a windmill - most importantly, what you intend to do with the device, and where. Perhaps you own a small ranch, a cabin spot in the hills, or some place to use the machine. Go there and conduct a wind survey.

A wind survey can be done several ways. Start by asking local folks how much wind the area gets, how fast it usually blows and which way. Set up your own wind recording station. This can be as elaborate, or as simple as you wish. The lowest cost method, sold for less than ten bucks at any source of supplies for the sport of hang-gliding, is

called a Dwyer Windmeter. See Photo 1.

Hold this device into the wind and read wind speed directly. The accuracy of the Dwyer unit is sufficient for many design purposes. Homemade wind measuring devices may be considered also.

A more elaborate survey is conducted by going the whole route of purchasing (or building) some form of recording wind speed device. Photo 2 illustrates a weather station which is available from many aircraft supply companies. All that is needed to make a recording station is a recycled movie camera modified to take a few frames of photo data every hour or so.

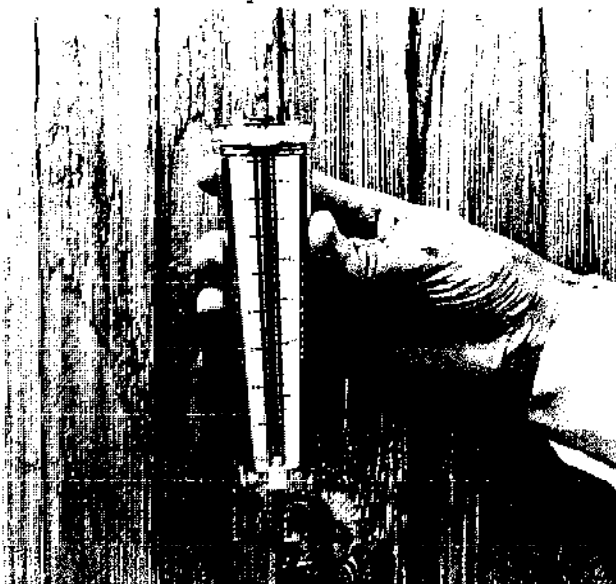

Photo 1 Dwyer Windmeter

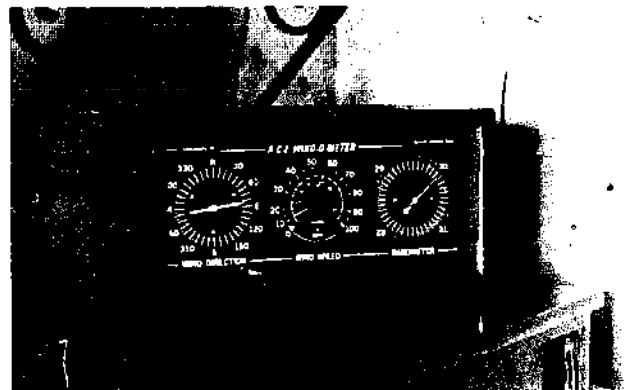
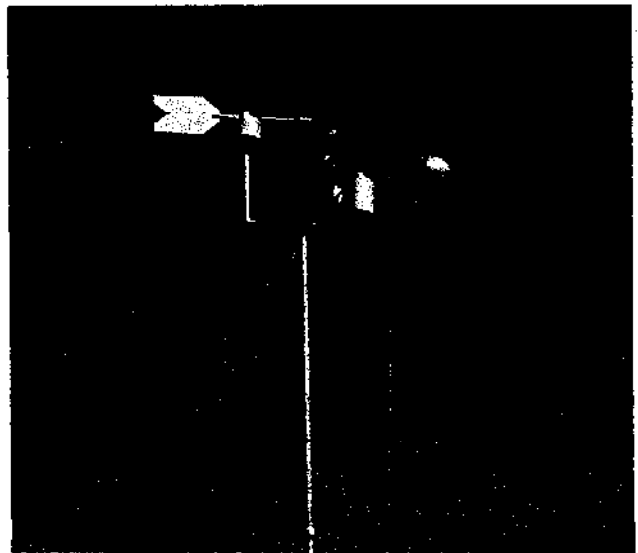

Photo 2 Weather Station

In most areas where you will likely consider installing a wind power system you are attempting to determine some form of average wind speed during the period of time the wind blows. For small, private uses of wind energy, the wind survey data need not be entirely accurate but should, since wind energy is basically free for the taking, be somewhat conservative. Keep in mind that a portion of the usable wind energy comes from gusts, or pulses of changing wind speed (and direction). Your windmill will be a mechanical conglomeration of heavy parts which take time to accelerate to a different speed, and a wind pulse of short duration may pass before the windmill can speed up to take advantage of the increased available wind power. Similarly, a short duration slowing of the wind will not necessarily cause a noticeable change in the windmill, but in this case, since the windmill is presumably under load, it will, in fact, slow down whenever possible. From this we can see that a wind device tends to average the short duration gust pulses into a more or less constant power setting. Thusly, we can, for simplicity, concern ourselves with the average wind speed.

It should be noted that a wind survey should be conducted at various heights above the ground. Wind speed only 100 feet above the ground can be as much as half again what it is measured at the surface. See Figure 2. This increase in wind speed is determined by the shape of the local terrain, surface obstructions which slow the airflow along the ground, and the nature of the local wind. Since faster wind means more power, it may be to your advantage to consider possible long reach windmill tower structures.

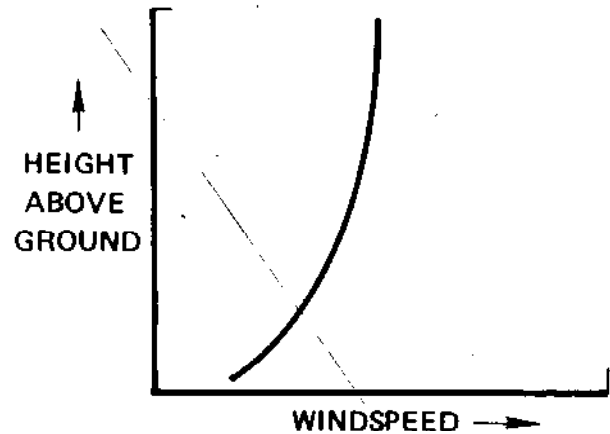

Figure 2 Typical Wind Profile

EXAMPLE

Using the Dwyer Windmeter (See Photo 1) a wind survey is conducted which yields the following sample data:

<u>TIME</u>	<u>WIND SPEED (MPH)</u>
6 pm	2
7 pm	8
8 pm	14
9 pm	12
10 pm	10
11 pm	15
12 pm	13
1 am	7

A trend appears for several days which indicates an average of 12 miles per hour. You have a choice now of using this value, or of altering it slightly downward in the interest of conservative design. Talking with the local folks, you determine that the wind speed averages slightly higher this time of year. You alter the average to be 10 miles per hour. You determine also that this value can be relied on for 20 hours per week.

POWER FACTOR FOR WINDSPEEDS FROM 10 TO 60 MILES PER HOUR

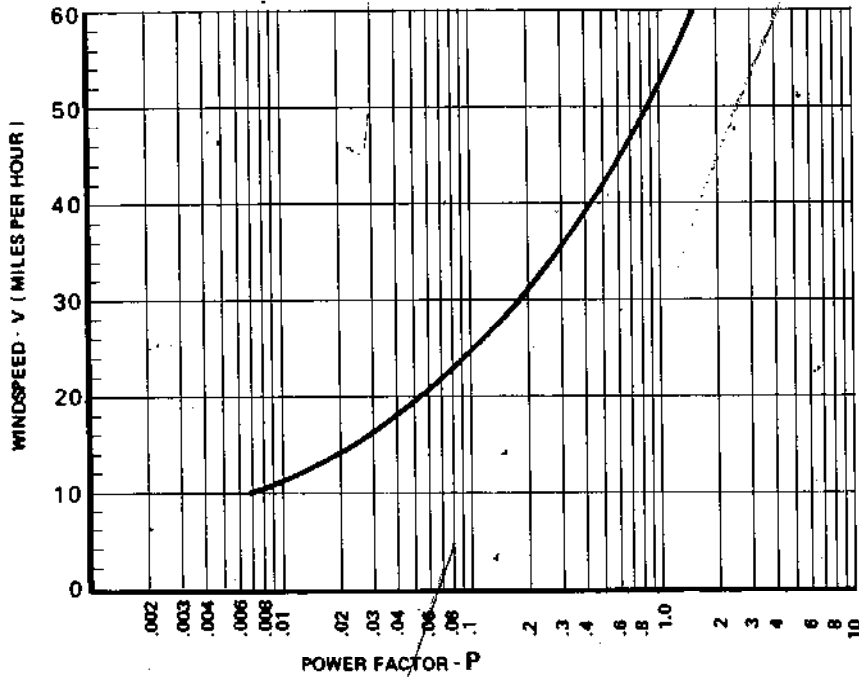

V (MPH)	P
0	0
1	.000069
2	.000055
3	.00019
4	.00044
5	.00087
6	.0015
7	.0024
8	.0036
9	.0051
10	.0069
15	.023
20	.055
25	.108
30	.187
35	.297
40	.444
45	.632
50	.866
55	1.15
60	1.50

POWER FACTOR FOR WINDSPEEDS FROM 1 TO 10 MILES PER HOUR

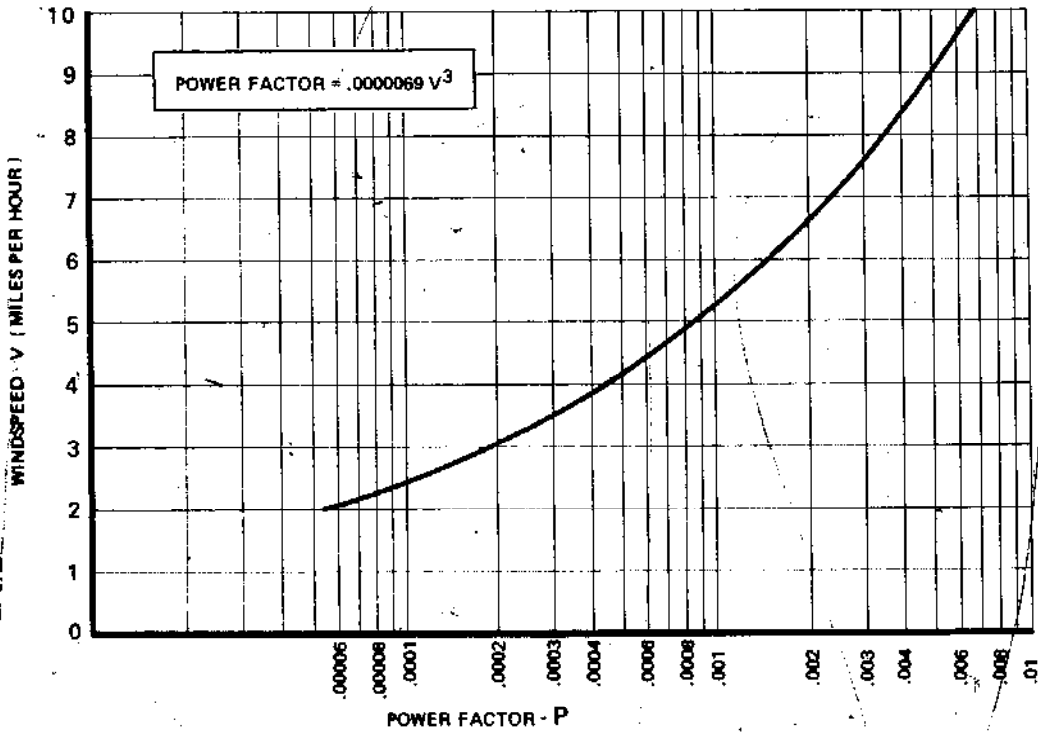

CHART B (for Equation 1)

WIND POWER

Here, we shall discuss actually how much power is available in a wind of known velocity. Recall that velocity was determined as an average value. Also, we established just how much power would be required to accomplish the task for which our windmill shall be designed. It follows, then, that we must equate power required to power available in order to establish the size and shape of the windmill which will accomplish the task.

To calculate wind power, find the wind speed value on the vertical line of CHART B. Look horizontally to the intersection with the curve, then down to read a value called P, a power factor. This value is horsepower per square foot of frontal area of the windmill. Use the following simplified formula to calculate actual horsepower output of the windmill. All terms of this formula will be discussed in detail.

████████████████████

EQUATION 1'

$$\text{HORSEPOWER} = P \times A \times E$$

- where P = Power factor found on CHART B
A = Frontal area of the windmill measured in square feet
E = Efficiency factor for the windmill design

Note: To convert horsepower to watts, simply multiply horsepower by 746.

████████████████████

EXAMPLE 1

A windmill with a frontal area (A) of 100 square feet and an efficiency factor (E) of 0.25 is installed in an area with an average wind speed of 15 miles per hour.

Problem: Calculate the horsepower output of this machine.

Solution: Using CHART B note that for a 15 mile per hour wind, $P = 0.023$

Then:
Horsepower = $0.023 \times 100 \times 0.25 = 0.58$

EXAMPLE 2

The windmill in Example 1 generates 0.58 horsepower.

Problem: Calculate the watts of electrical energy this windmill generates.

Solution: Watts = $0.58 \times 746 = 429$

████████████████████

WINDMILL SIZE

For windmills of the propeller or multiblade type which rotate on a horizontal axis (See Figure 3A) use CHART C to calculate the frontal area. You need to know windmill diameter measured in feet.

For windmills which rotate about a vertical axis (See Figure 3B) simply multiply the width by the height - each measured in feet.

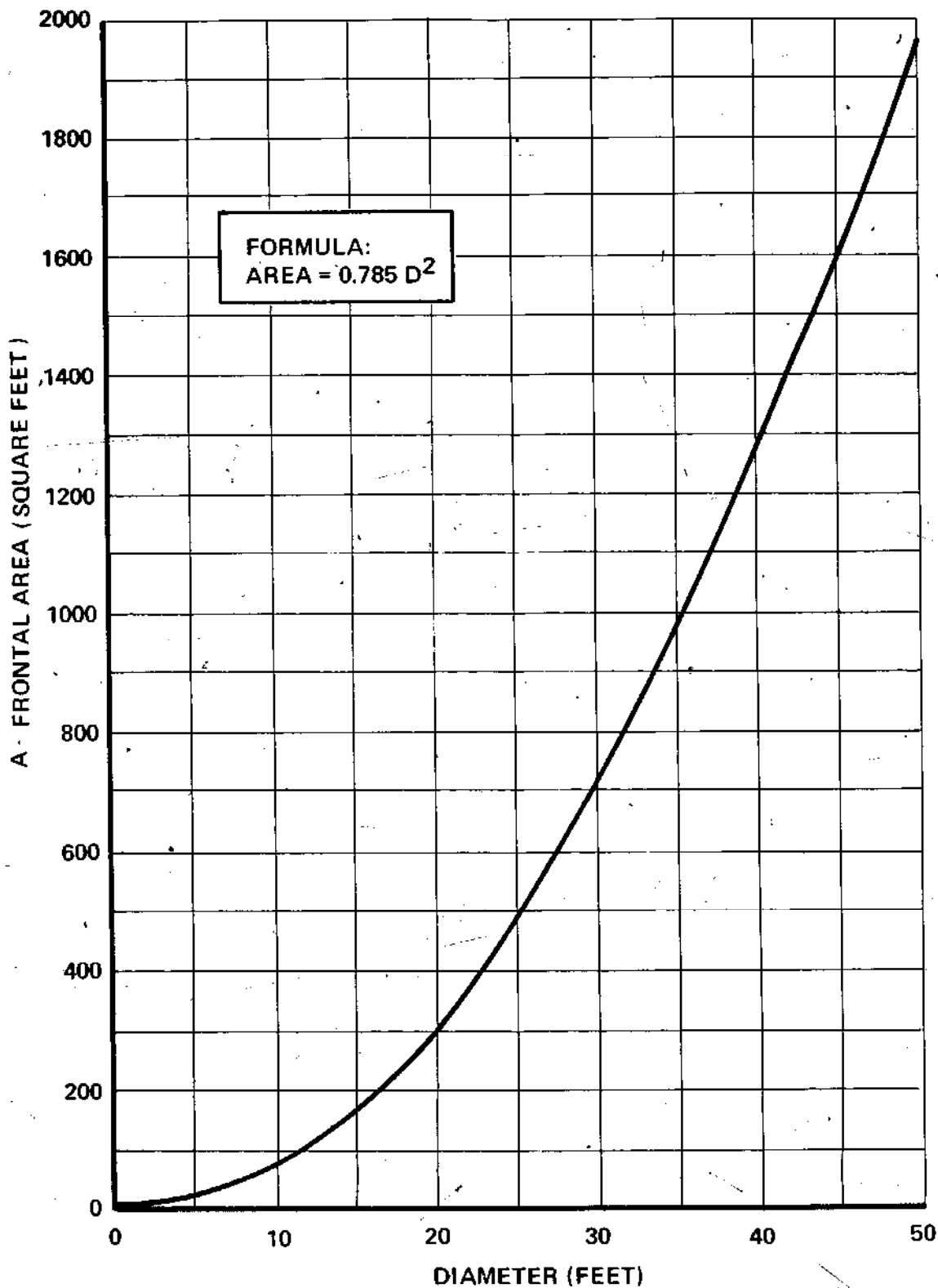

$$A = .785 D^2$$

D	A
1	.79
2	3.14
3	7.07
4	12.57
5	19.63
6	28.27
7	38.48
8	50.27
9	63.62
10	78.54
11	95.03
12	113.10
13	132.73
14	153.86
15	176.71
20	314.16
25	490.87
30	706.86
35	962.11
40	1256.64
45	1590.43
50	1963.50

CHART C (for Equation 1)

WINDMILL EFFICIENCY

The previous calculations called for a value of the efficiency factor. Since no manmade device is ever 100% efficient at doing whatever it is designed for, we must either assume a low value of efficiency in the interest of conservative design (a sort-of guarantee that we'll get the power we need), or find some means of reliably estimating a value of E that corresponds to our particular windmill design. A windmill extracts power from the wind by slowing the wind down. If the wind could be stopped completely by a rotating device, then 100% of the wind power could be extracted. The wind cannot be stopped; it is only slowed down by about a third of its original speed, which means that the actual theoretical maximum wind power available to a windmill is 59% of the total.

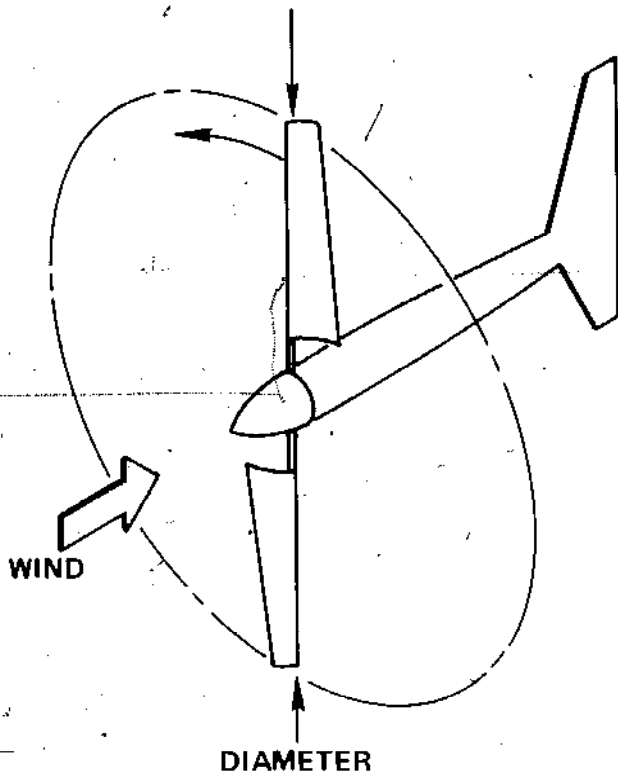

Figure 3A Horizontal Axis Windmill

Now, how much of the 59% of the total wind power is actually extracted? This depends on the design of the windmill, the gear losses, the degree of accuracy with which the builder of the machine reproduces the necessary shape and size, and so on. Obviously 59% is still only theoretical. Practical values of overall efficiency, the E in our formula, lie between 0.1 (or 10%) and 0.4 (40%), not much more. By using real values for E in our calculations for horsepower or watts, the result will be real, attainable values of windmill power.

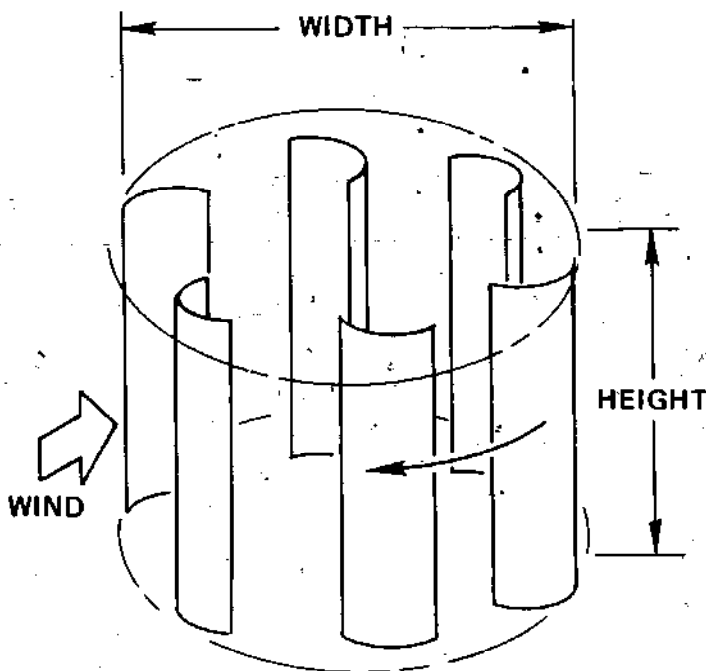

Figure 3B Vertical Axis Windmill

We shall explore several examples of these calculations in use following an explanation of how to estimate E . The actual value of E depends on the type of windmill design used and a factor of speed ratio, which we shall discuss now.

TYPES OF WINDMILLS

There are two primary classes of windmills:

1. Those with power shafts mounted vertically.
2. Those with power shafts mounted horizontally.

Windmills, as discussed in this text, generate power while rotating. Rotation means that windmill components near the center or rotation will be moving relatively slowly, while portions near the outer edges (tips) will be moving faster, in proportion to the distance from the center of rotation (radius). See Figure 4.

This gives a chance to discover a speed ratio which will be used in future calculations: u/V ratio (called u -over- V ratio) is simply the speed of any area of a windmill such as the tip of the blade divided by the wind speed. Both speeds must be of the same units like miles per hour, or feet per second. Obviously, the u/V ratio at the tip - written $u/V(\text{tip})$ is a larger number than, say, the u/V ratio halfway between the tip and the center of rotation. Typical windmill calculations will use the u/V ratio for the tip, or outermost area of the machine. Speed ratio values you might see are 1 to 2 for slow speed machines, and 5 to 7 or 8 for the more modern high speed machines.

Now before proceeding with calculations of E , the following is a comparative discussion of types of windmills as related to the value and estimation of E . As will be seen, the type of windmill selected to satisfy power requirements affects the efficiency, and hence, size of the machine. A low efficiency windmill will have to be larger than a comparable high efficiency windmill to generate a certain amount of power.

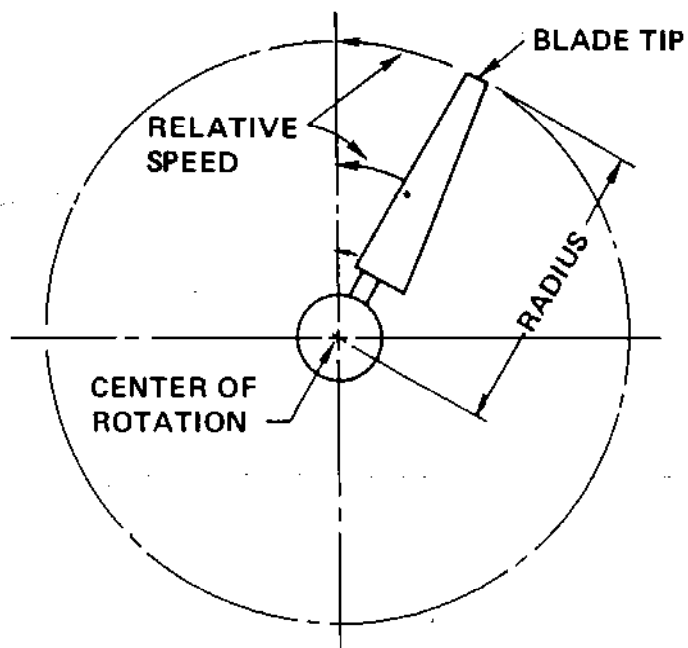
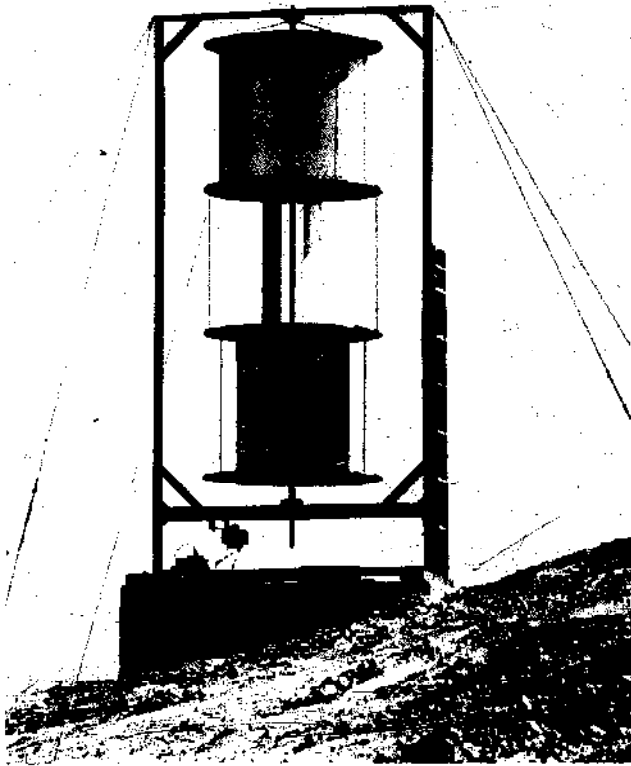

Figure 4

VERTICAL AXIS WINDMILLS

applications which need neither high rotation rates or high power. See Figure 5.



Consider the fact that wind turbine type devices develop power by moving in the same direction as the wind. Power results from wind force acting on the surface which is moving with the wind. Obviously, the surface cannot move faster than the wind or no power would result. Recall, however, from the discussion of u/V ratios that the outer extremities of the machine move faster (not in revolutions per minute, but in the mile-per-hour surface speed) than areas closer to the center of rotation. From this, we can see that the average speed ratio across the radius of a wind turbine will be lower than the wind, say about 0.4, while the tip u/V ratio might be, say 1.2. The tip, in this case isn't contributing to the generation of power, but the surface, on the average, is.

Vertical axis windmills generate power equally well with wind from any direction because these machines do not need to move on their mounts as wind direction changes. These devices are usually easily constructed, lend themselves well to roof-top simplified mounting, and perform reasonably, though not typically as well as high-speed horizontal axis machines.

Design concepts for vertical axis machines extends from simple flat plates at ends of swinging arms, to turbine type devices. The less exotic turbine, or "Savonius" types rotate relatively slowly. This can be advantageous for water pumps and other

One can determine from this that the vertical axis wind turbine is not as efficient as other types. Obviously, the concept of efficiency does not have the same importance for windmills as it does for other power devices. Wind is available in unlimited quantities and the main problem is not necessarily efficient conversion, but rather low cost conversion of power. It may be considerably cheaper for a designer to cut a 55-gallon oil drum in half to make a Savonius Rotor than, say, for the same individual to build a highly efficient machine of another design. If, however, the 55-gallon Savonius Rotor doesn't satisfy power requirements it's really not the cheapest solution.

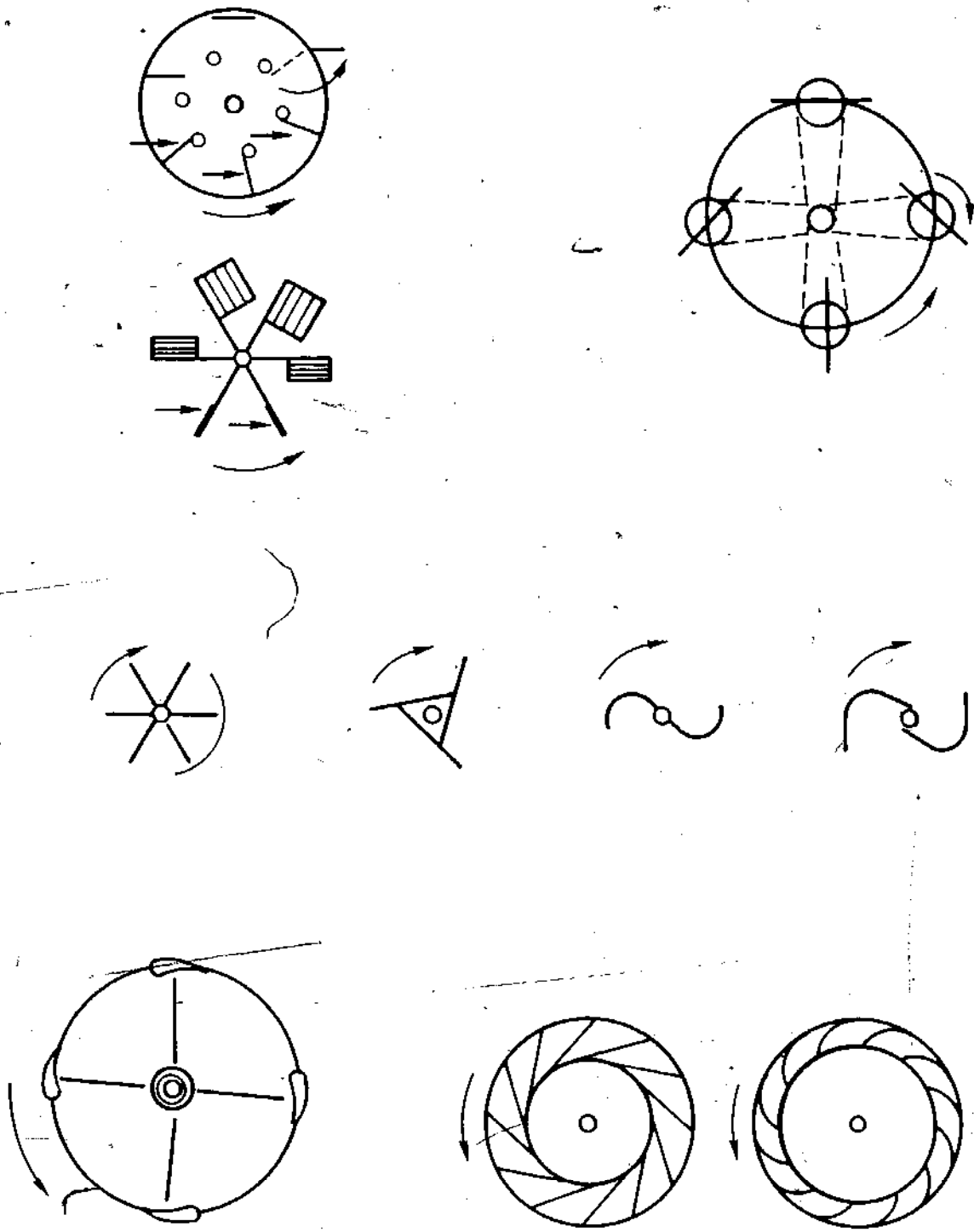
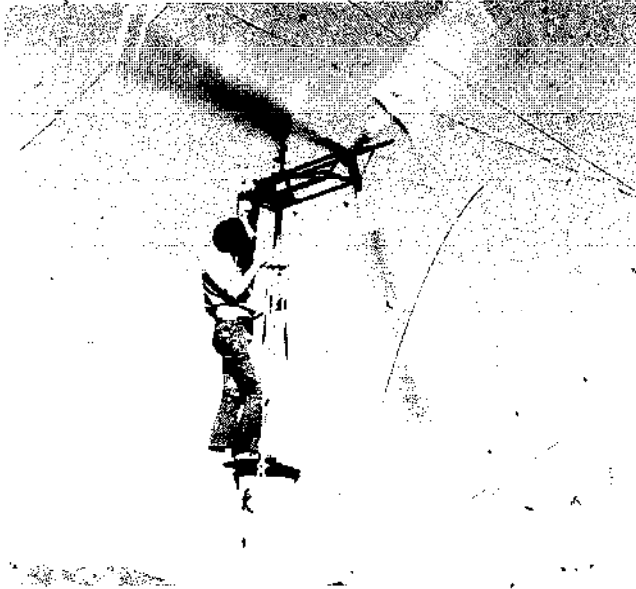

Figure 5 - Vertical Axis Windmill Concepts

HORIZONTAL AXIS WINDMILLS



Horizontal axis windmills are typically more complex than vertical axis machines. However, the small circular cross-sectional shapes of these machines enclose large frontal areas (recall that the vertical axis machines have portions of their frontal area moving into the wind and not producing power), and, it follows that horizontal axis windmills usually produce greater amounts of power than equivalent size vertical axis machines.

This type of windmill requires being aimed into the wind. This can be accomplished by installing the blade in front of the directional pivot with a large vertical vane surface behind or by installing the blades behind the pivot and allowing the blade drag to keep the machine aimed.

Large horizontal axis machines are subject to high centrifugal loads on the blades, and in high winds, very large bending loads which tend to break things apart. In addition, rapid changing direction of the wind will cause high gyroscopic forces in the rotating blades.

HYBRID WINDMILLS

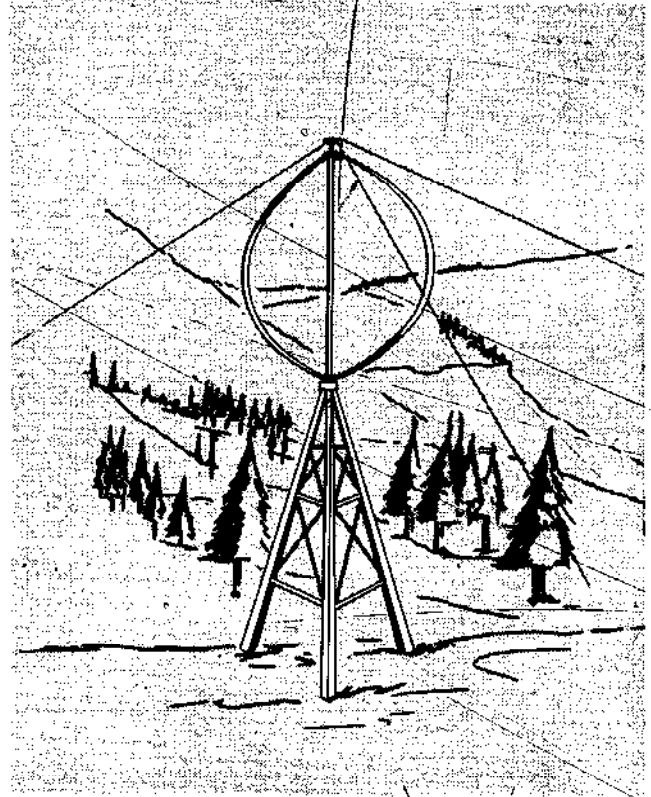

Figure 6 "Eggbeater" Hybrid

Here, we shall depart from tradition and discuss a class of windmill that promises simplicity of design and construction, and high efficiency. The hybrid machine is a vertical axis machine which uses the aerodynamic blades of a horizontal axis machine. Blades moving through the wind produce power; more importantly, blades travelling into the wind, and across wind, produce power. These windmills operate at u/V (tip) ratios much greater than one. Typical of the hybrid machine class is the "eggbeater." See Figure 6. This windmill is the result of Canadian research and is based on patents dating into the 1920's.

Hybrid machines combine all of the aerodynamic advantages of the high-speed horizontal axis windmill, with the simplicity of the vertical axis machine.

When all of the trade-offs have been studied, a designer is left with the final decision as to which type of windmill to use in a given project. Figure 7 illustrates the relative values of efficiency factor (E) for different types of windmills, operating at various u/V ratios.

Appendix A in this text presents actual design values of E for specific types of machines.

It is now possible to estimate E and complete power calculations started earlier. As a method of design, one needs only to select the type of windmill that appears to suit design requirements, estimate the builder's ability to construct a reasonable copy of same, and estimate the efficiency factor (E) from the data outlined with the chosen type of windmill.

Consult Appendix A for data on E values relative to design u/V. Keep in mind that, while high u/V

ratios may mean higher E values and less complex gearing due to the faster turning machine. A significant effect is high centrifugal force acting on the machine. Centrifugal force is the tendency for parts mounted near the center of rotation to stretch and move toward the tip, while the tip tries to part company entirely. Centrifugal force increases with the square of rotational speed, which means that a windmill that is just strong enough at, say, 100 revolutions per minute, must be four times as strong at only twice the rotational speed - 200 RPM.

Putting everything together:

1. Estimate power required.
2. Determine average wind speed available.
3. Select a windmill type.
4. Estimate efficiency.
5. Calculate windmill size.

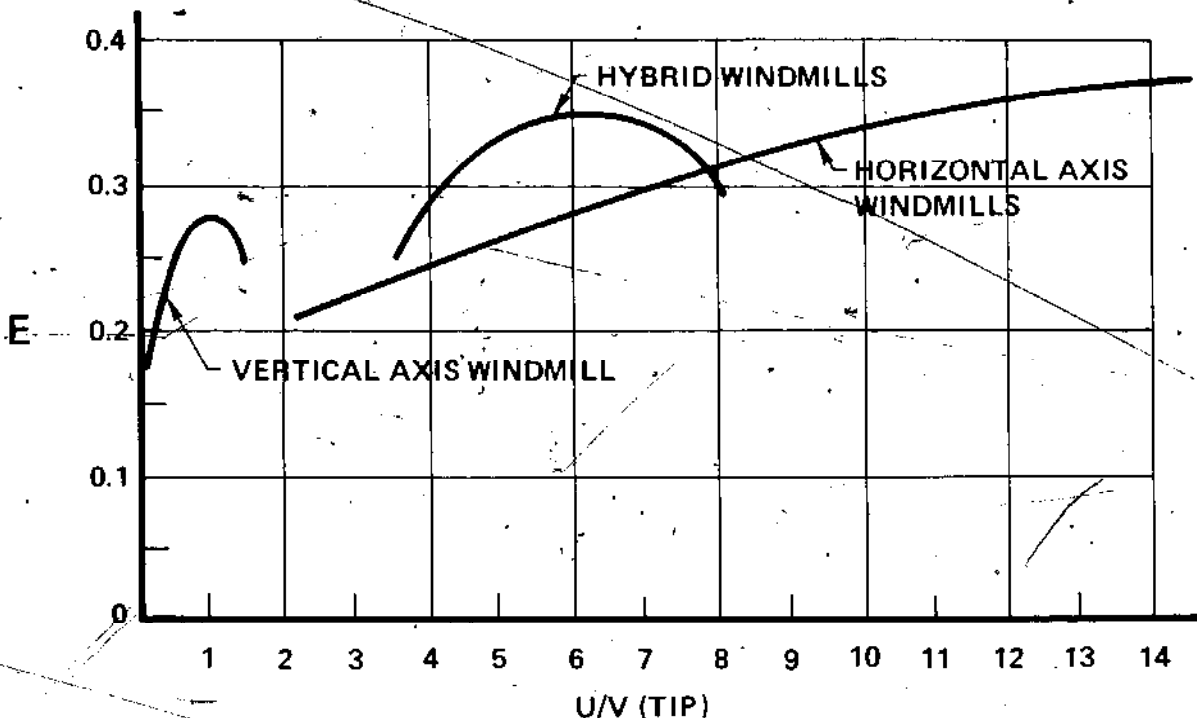
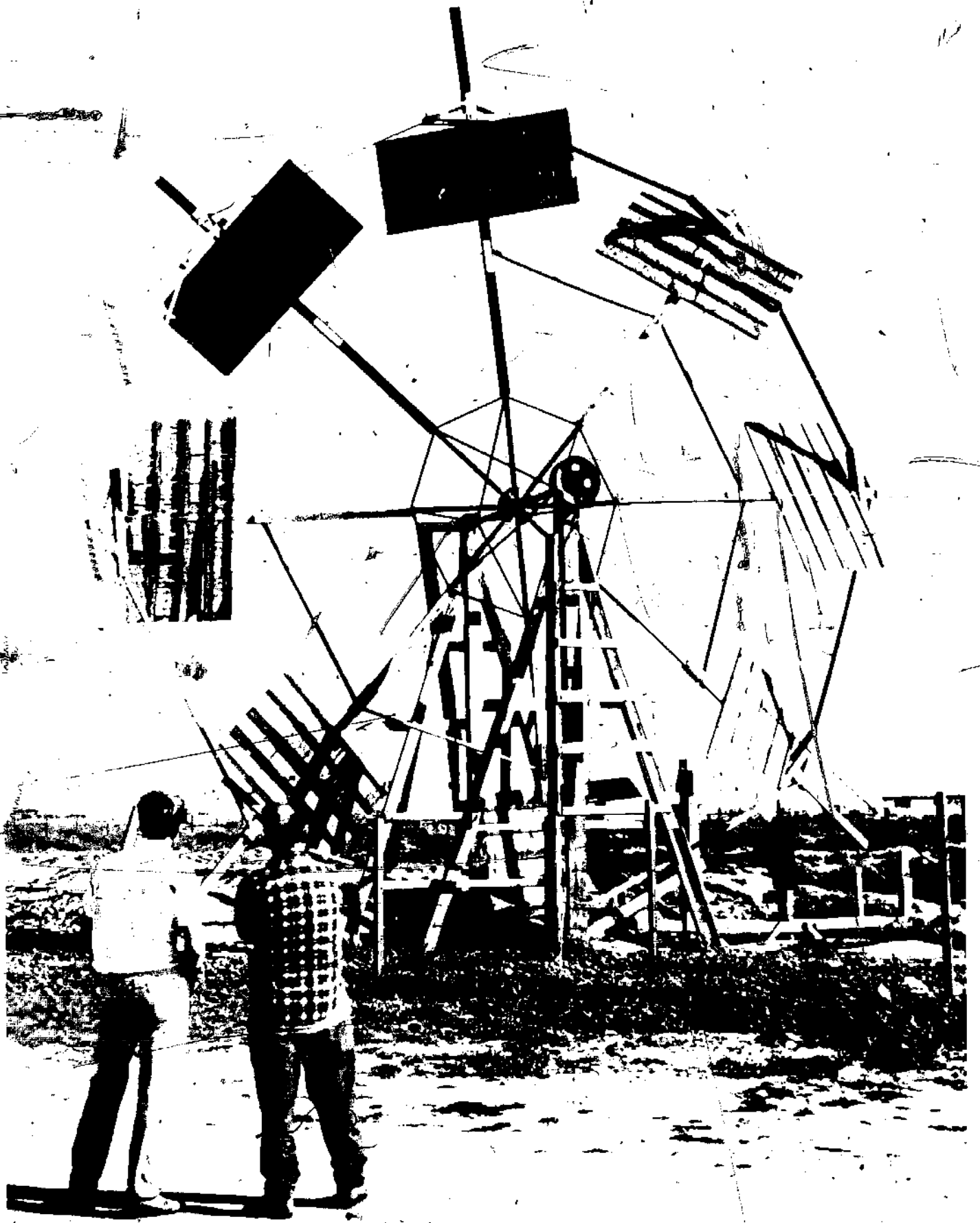
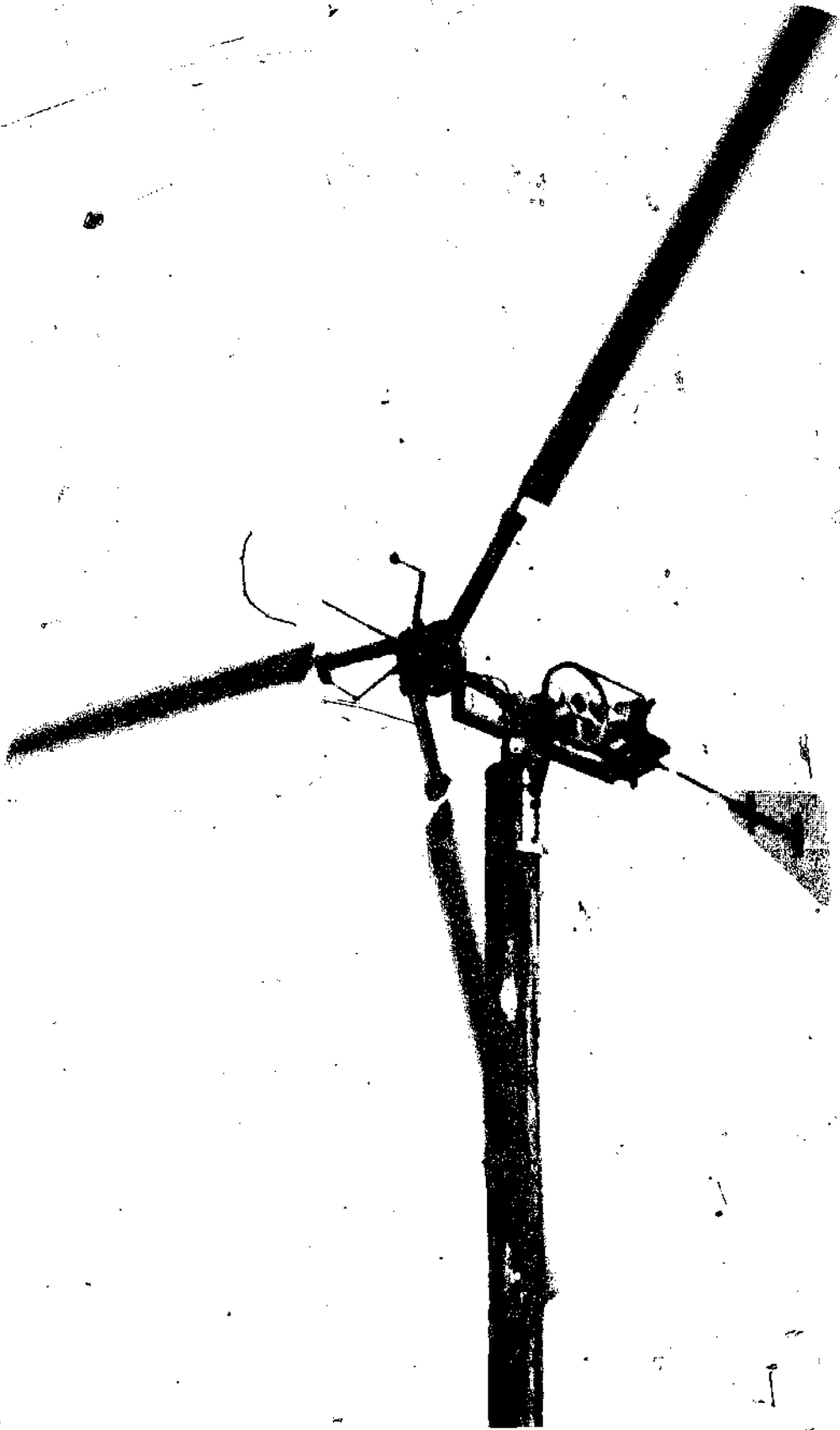

Figure 7 Relative Efficiency of Three Windmill Types



Section B . . . AERODYNAMIC DESIGN



AIRFOILS

Before discussing the aerodynamic design of a windmill using airfoils we should review the factors which affect airfoil performance.

TYPES OF AIRFOILS

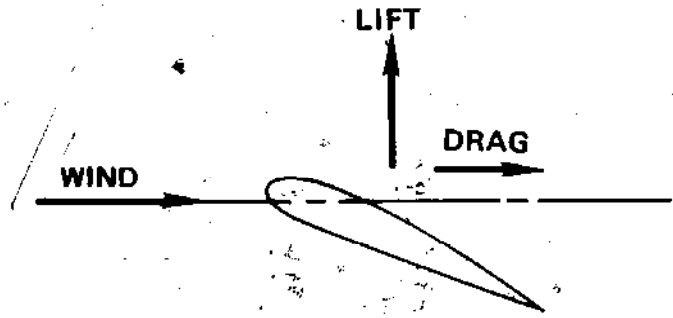
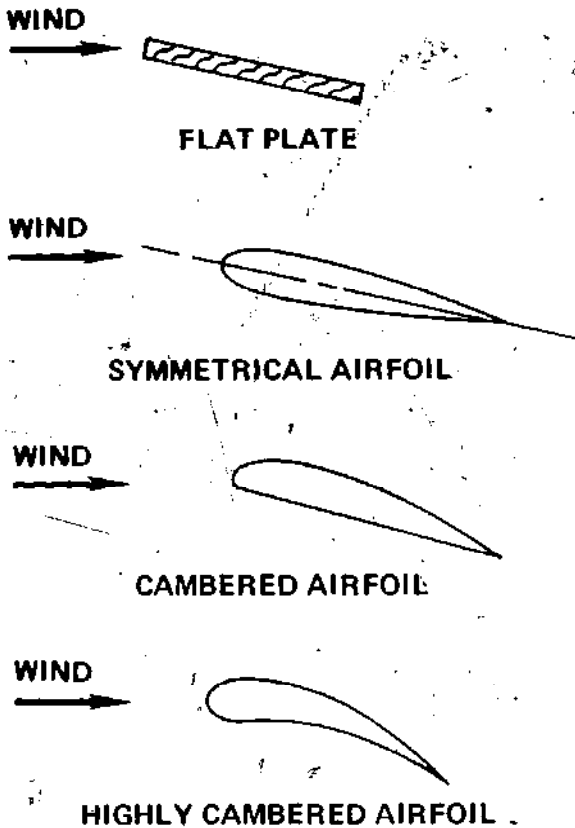

Figure 8

All airfoils require some angle with the wind in order to produce lift. The more lift required, the greater the angle. The angle is measured between a line which connects the leading edge with the trailing edge which is called a chord line, and the wind direction. The angle is called the airfoil's angle of attack. Figure 9 illustrates the angle of attack.

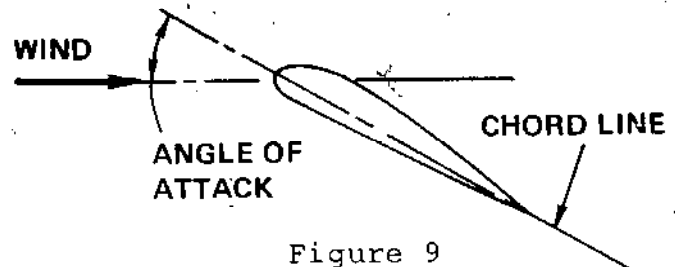

Figure 9

AIRFOIL AERODYNAMICS

An airfoil is a surface over which air flows. The action of this airflow results in two forces directly related to windmill performance - LIFT and DRAG. Lift is measured perpendicular to the air flow - not the airfoil. Drag is measured parallel to the airflow. See Figure 8.

Figure 10 indicates the relationship of angle of attack with lift produced for the four basic types of airfoils. Notice that lift is represented by the term coefficient of lift, usually referred to as C_L or C-sub-L. You can think of lift coefficient as a number which represents percentage of maximum lift, but the following formula is presented as background information to show how lift coefficient is calculated. This formula is not actually needed in simplified calculations for windmill design.

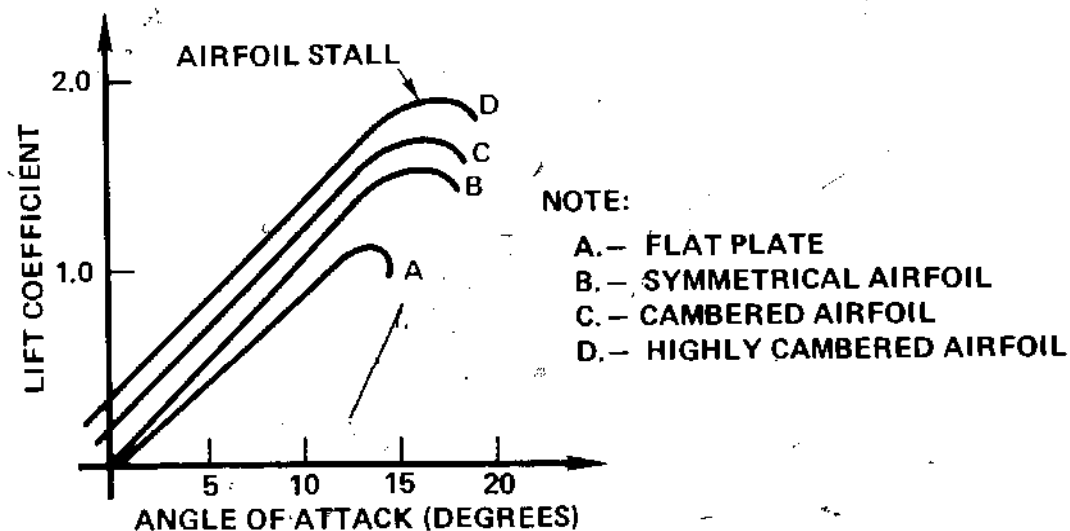

Figure 10 Airfoil Lift Coefficient

LIFT COEFFICIENT =

$$\frac{\text{Lift}}{\text{air pressure} \times \text{blade area}}$$

where Lift is the actual force measured in pounds produced by the airfoil blade.

Dynamic air pressure is the pressure acting on the blade caused by impact of wind on the blade - measured in pounds per square foot.

Blade area is the total area of the blades, measured in square feet - not to be confused with the frontal area of the windmill.

Technically inclined experimenters may find further explanation of this formula in Appendix D. Notice that, since dynamic air pressure is an impact pressure and is related to wind speed, if the wind speed increases, either lift increases, or lift coefficient decreases, or a little of both.

Unless the windmill is designed to change shape during operation, blade area is supposed to remain constant. Therefore, blade lift, which results in windmill horsepower, is determined by the coefficient of lift of the airfoil, wind speed, and the blade area which produces lift.

An interesting note to this is that windmill power is related to frontal area, rather than blade area, in our power calculations. We can see, then, that a windmill with small blade area will have to turn faster to produce required power than, say, a windmill with lots of blade area. The multi-blade waterpump type windmills generally turn very slowly since they have a large blade area.

From Figure 10, one can see that at a certain angle of attack lift stops increasing. This is the point of airfoil stall, where airflow breaks up, separates from the airfoil, and stops producing lift. Separated airflow still produces drag, though.

WINDMILL BLADE ANGLE

Windmill design calls for selecting an airfoil which produces maximum lift, with minimum possible drag. This means that the airfoil must "fly" at an angle of attack consistent with high lift, but not so high that the blade stalls. We must, then, develop a method for determining angle of attack, and actual wind direction relative to a moving blade.

Let's look at two simple cases:

1. Imagine a windmill blade moving to the left on this page with no external wind.



It should be obvious that the airfoil motion to the left causes the blade to "see" a relative wind directly to the right.

2. Imagine a windmill blade pointed to the left, but not moving. Add to the picture an external wind, blowing straight up the page - at a right angle to the blade. In this case the airfoil will "see" a relative wind at ninety degrees angle of attack.

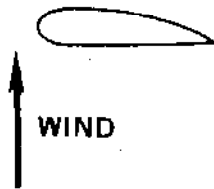

Combining the two cases, we now have the basis for analysis of a windmill blade. Imagine the airfoil blade pointed directly to the left, moving at a speed of, say, 10 miles per hour ($u = 10$ miles per hour in the u/V ratio). A wind blowing at right angles to the airfoil at, again, 10 miles

per hour ($V = 10$ miles per hour). Notice that the u/V ratio, which we previously used in estimation of windmill performance, is equal to one, in this case. We must now determine the relative wind, the wind the airfoil actually "sees". This relative wind is the result of two motions combined. One can imagine that, in the simple case of both u and V being at right angles to each other, and of the same speed the relative wind will split the two motions evenly.

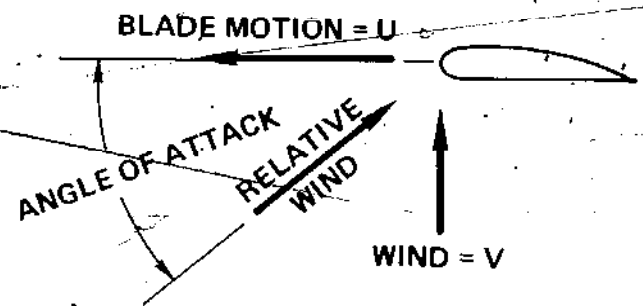

By splitting 90 degrees in two, we see that the relative wind makes a 45 degree angle with the chord line. Thus, the angle of attack equals 45 degrees.

Reviewing Figure 10, we can see that the maximum angle of attack we can count on our airfoil is approximately 15 degrees, which means that at 45 degrees our airfoil would be deep in a stall, not lifting. From this, it becomes apparent that the airfoil must be set at a blade angle relative to its direction of motion in order to adjust angle of attack. We can calculate blade angle:

EQUATION 2

BLADE ANGLE =

Wind angle - angle of attack +
airfoil zero angle

Where Wind angle is the angle the relative wind makes with the blade's plane of rotation.

Angle of attack is selected from Appendix B.

Airfoil zero angle =
0 for symmetrical airfoil
2 for lightly cambered
4 to 6 for highly cambered airfoils.

EXAMPLE

Wind angle = 20 degrees
angle of attack = 6 degrees
zero angle = 4 degrees

then:

Blade Angle = $20 - 6 + 4 = 18$ degrees.

By way of review study Figure 11 to see the angular relationship between the chord line and the relative wind (angle of attack), between the chord line and the direction of motion of the airfoil (blade angle). Airfoil zero angle is the angle at which zero lift is produced.

Design of a windmill which uses airfoil blades requires the ability to determine blade angles. We need to calculate wind angle, in order to continue our blade angle calculations. Use CHART D, which is a graph of wind angle versus u/V ratio, to find wind angles.

Now, to calculate u/V ratio, consider the following: In previous discussion of windmill performance u/V ratio was referenced

to tip speed. u/V ratio applies to any point on a rotating windmill. Review Figure 4 to see that u/V at the center of rotation would equal zero. u/V increases from zero at the center to the design tip speed-ratio as the radius increases. As a method of design, one merely selects a value of tip speed u/V ratio, and proceeds with other calculations. With a tip u/V ratio known, one can calculate u/V ratio at any other radius.

EQUATION 3

u/V at any radius =
 $u/V(\text{tip}) \times \text{radius} / \text{tip radius}$

Where radius is measured from the center of rotation to the area for which u/V is to be calculated.

tip radius equals windmill diameter divided by two.

EXAMPLE

A 20 foot diameter windmill has a u/V(tip) of 7, and the radius from the center of rotation to the root of the blades (root end is the end of the blade closest to the center of rotation) equals 2 feet.

Calculate u/V(root) = $7 \times 2 / 10 = 1.4$

u/V at any other radius may be calculated in a similar fashion.

For windmills where the rotational speed in revolutions per minute is known, one can calculate u/V from the following formula:

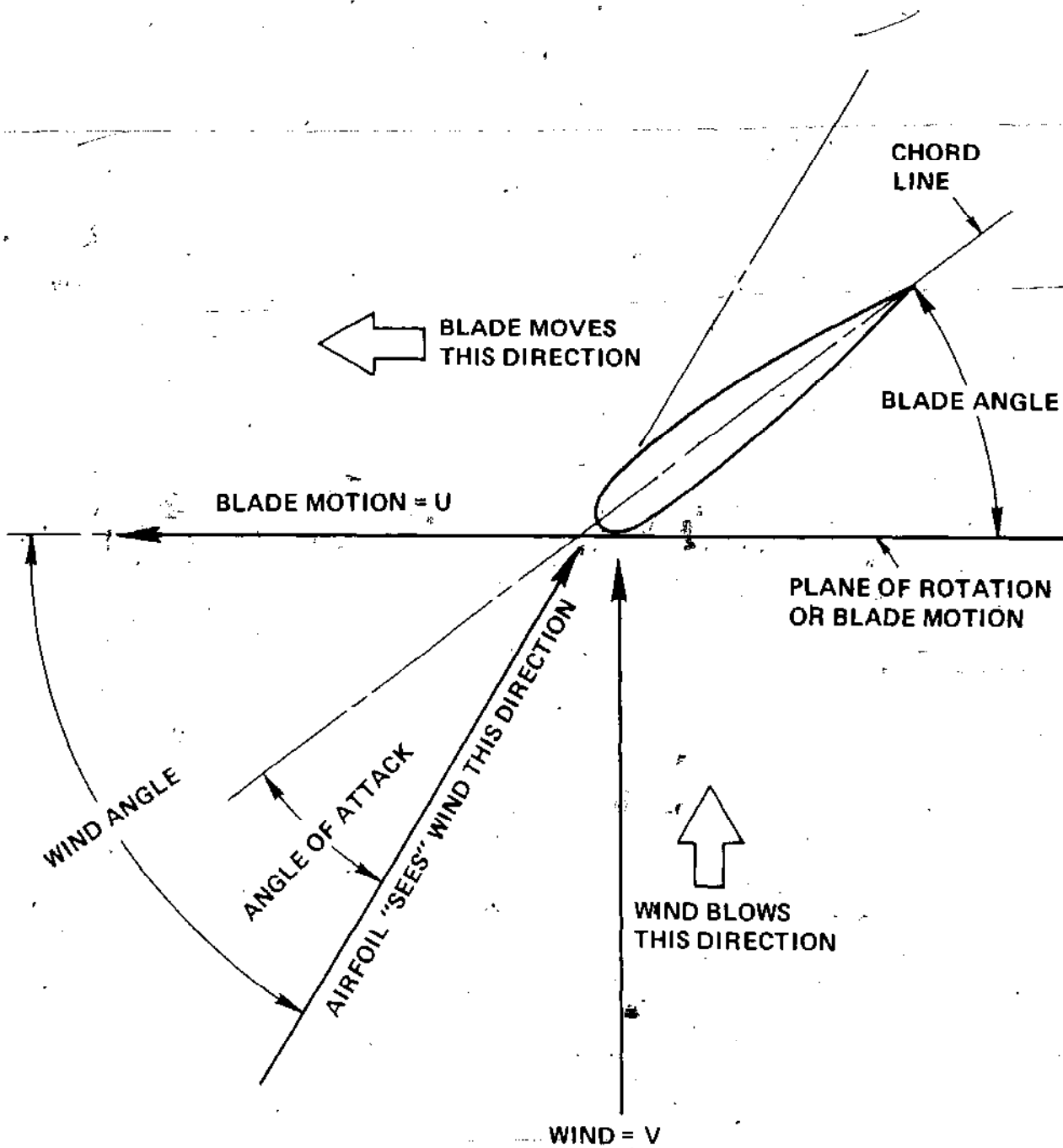

Figure 11 See Equation 2

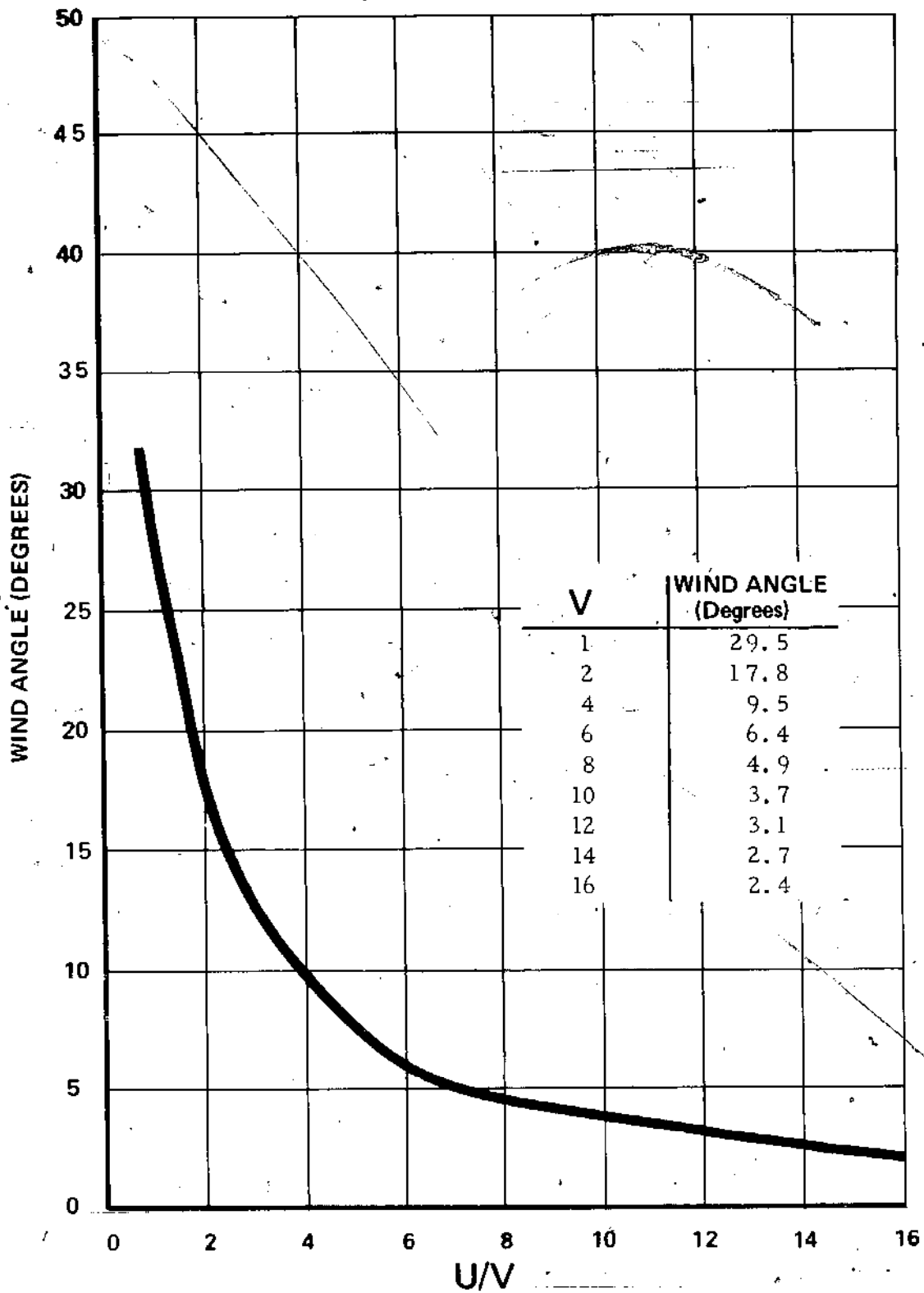

CHART D (for Equation 2, see Equation 3 and 4)

EQUATION 4

$$u/V = 0.105 \times N \times r / (k \times V)$$

where N = rotational speed in revolutions per minute.

r = radius to the section where u/V is being calculated - measured in feet.

V = wind speed

k = a constant to adjust V.

if V is measured in miles per hour, k = 1.47

if V is measured in feet per second, k = 1.0

HYBRID BLADE ANGLE

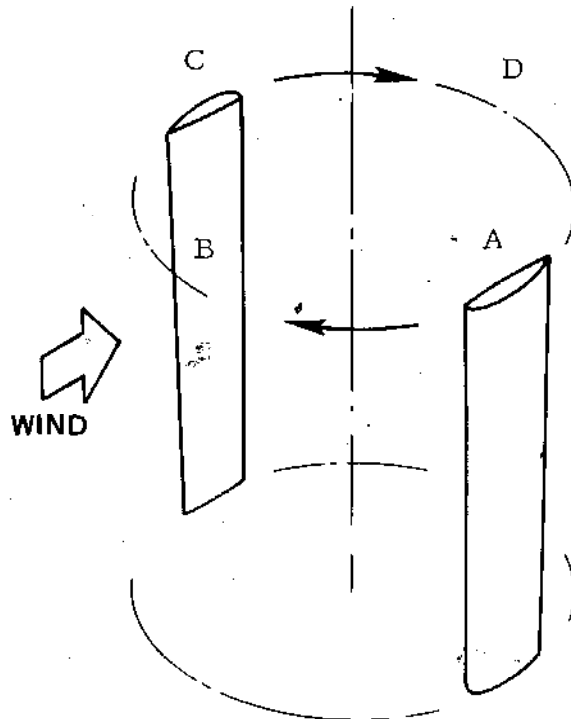

Figure 12 Hybrid Concept

EXAMPLE

A windmill turns 300 revolutions per minute in a 15 mile per hour wind. The diameter is 12 feet. The diameter at the blade root is 2 feet.

Problem: Calculate u/V(tip), and u/V(root).

Solution: $u/V(\text{tip}) = 0.105 \times 300 \times (12/2) / (1.47 \times 15) = 8.6$

$u/V(\text{root}) = 8.6 \times 2/12 = 1.4$

Notice that the tip operates at a higher u/V ratio than the root. Using CHART D, we can calculate wind and blade angles for this windmill.

We now have all the tools necessary to design blade angles. Figure 10 is a general graph of lift versus angle of attack. Specific data for several airfoils applicable to windmill design are presented in Appendix B of this book.

While a simple calculation for the angles along the blade of a conventional horizontal axis windmill will yield angles which are valid throughout the entire flight path of such machines, hybrids pose a slightly different situation. The vertical axis rotation of the blades causes the relative wind angle or "wind angle" (see Figure 11) to change in a fashion approximated by Figure 13. Figure 12 illustrates the hybrid concept and shows the points along the rotational path of the blade (A to C) which relate to wind angles illustrated on Figure 13. Notice that at low u/V ratios, the blades are operating at angles greater than stall but at higher u/V ratios, these blades are well within their normal angle of attack range (see Figure 10).

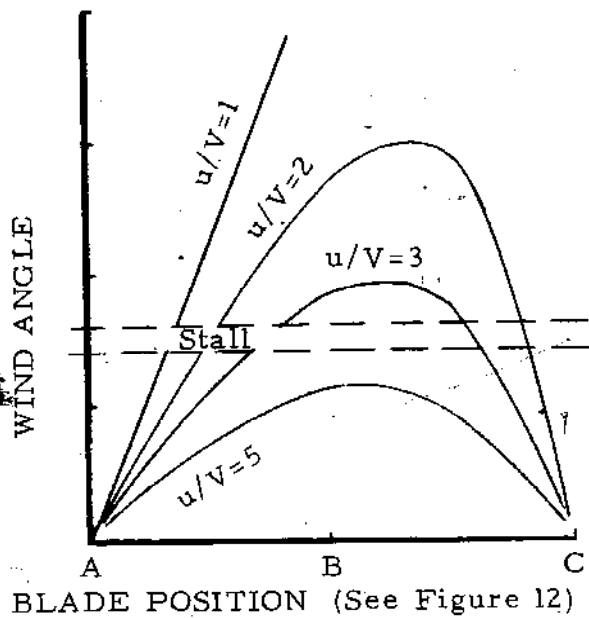

Figure 13 Hybrid Blade Angles

It is apparent, then, that some form of assist will be needed to spin-up a hybrid to its operating range of about 4-to-6 (u/V). A small Savonius Rotor can be used (see inside back cover), a spin-up motor, or the blades can be articulated to an adjustable blade angle - which implies a certain amount of machine complexity.

AIRFOIL SELECTION

Selecting a good airfoil for a given design is a not-so-serious problem. Just about any airfoil selected will work, and most will work well. The problem starts when a designer selects one of the newer super high performance airfoils. These airfoils are designed for high performance sailplanes and should work well on windmills, but

Windmills live outside in dirty rainy, windy, bird droppy areas. This means that even if the builder of a windmill constructs ultra-smooth molds and produces

glasslike blades of precise contour, they'll only be that smooth for a short time. The high performance airfoils work well as long as they are precise and smooth, but change their contour just a little bit and the performance drops off rapidly. Sailplane pilots are known to polish their wings and measure the contour for variations of less than a thousandth of an inch. Windmill owners just mount their machines out in the breeze and stop thinking about them. From this, one might consider sacrificing the high performance offered by these new airfoils and select an old-fashioned, more docile (lower performance) airfoil which will not so measurably be affected by imperfections. Examples of docile airfoils include "Clark Y", some of the Göttingen airfoils, and the thicker NACA laminar and earlier profiles.

Airfoils appropriate to hybrid design are symmetrical - such as the NACA 0012, and can (in some cases should be) plotted (see Appendix B) along a line with a curvature equal to the radius of the machine being designed. Such an airfoil flying along a straight path will act like a cambered airfoil, but when mounted on the radius arm of a hybrid will perform like a symmetrical airfoil.

BLADE AREA DETERMINATION

One must consider, in the design of windmills, two different areas - not to be confused with each other:

Blade surface area - the total surface area of the airfoil blades.

Windmill frontal area - the frontal area used in calculations of windmill power.

If we divide blade area by frontal area, an interesting ratio called solidity is calculated. Think of it this way: wind approaching a windmill which has so many blades that you can't see clear through them will strike a fairly "solid" surface, while a wind will not strike a "solid" surface on a one or two blade machine.

EQUATION 5

SOLIDITY = Blade area / Frontal area

Notice that, if solidity equals one, blade area equals frontal area. This is approximately the case for the multiblade water pump type windmills.

A two or three-blade windmill has a solidity of about 0.2, which means that the blades are rather thin; not much lifting area, but the relative wind speed working on the high speed airfoil produces the required lift.

To select a solidity factor for a particular windmill, use CHART E. A solidity value on the high side of the envelope is selected for windmills where the design lift coefficient is approximately half the maximum value of the airfoil. A low solidity value is selected when a high percentage of the maximum lift capability of the airfoil is expected. Recall, however, that we selected values of angle of attack when blade angle calculations were performed. If a designer selects a lower angle of attack, say, 8 de-

grees, a lower lift coefficient results. The lower lift coefficient will require a larger blade area.

EXAMPLE

A windmill is designed for high speed operation at $u/V = 6$. Frontal area equals 100 square feet. From CHART E, select a solidity factor. We decide to stay on the low lift curve (upper curve). Note that solidity equals approximately 0.07 at $u/V = 6$. Then blade area = $100 \times 0.07 = 7$ square feet.

BLADE PLANFORM

Blades may be built with the chord length at the tip equal to the chord length at the root, or may be tapered so that the root chord is as much as 1.5 times that of the tip chord length. Note that in the multiblade water pump machines, the blades are sometimes tapered the other way; tip chord is longer than root chord. To calculate chord length when you know blade diameter and blade area, simply divide blade area by blade length (distance from root end of blade - not center of rotation - to the tip). In the case of the untapered blade, the chord calculated in this way will be both tip and root length. For the tapered blade, this chord length will be the average chord for the tip and root lengths.

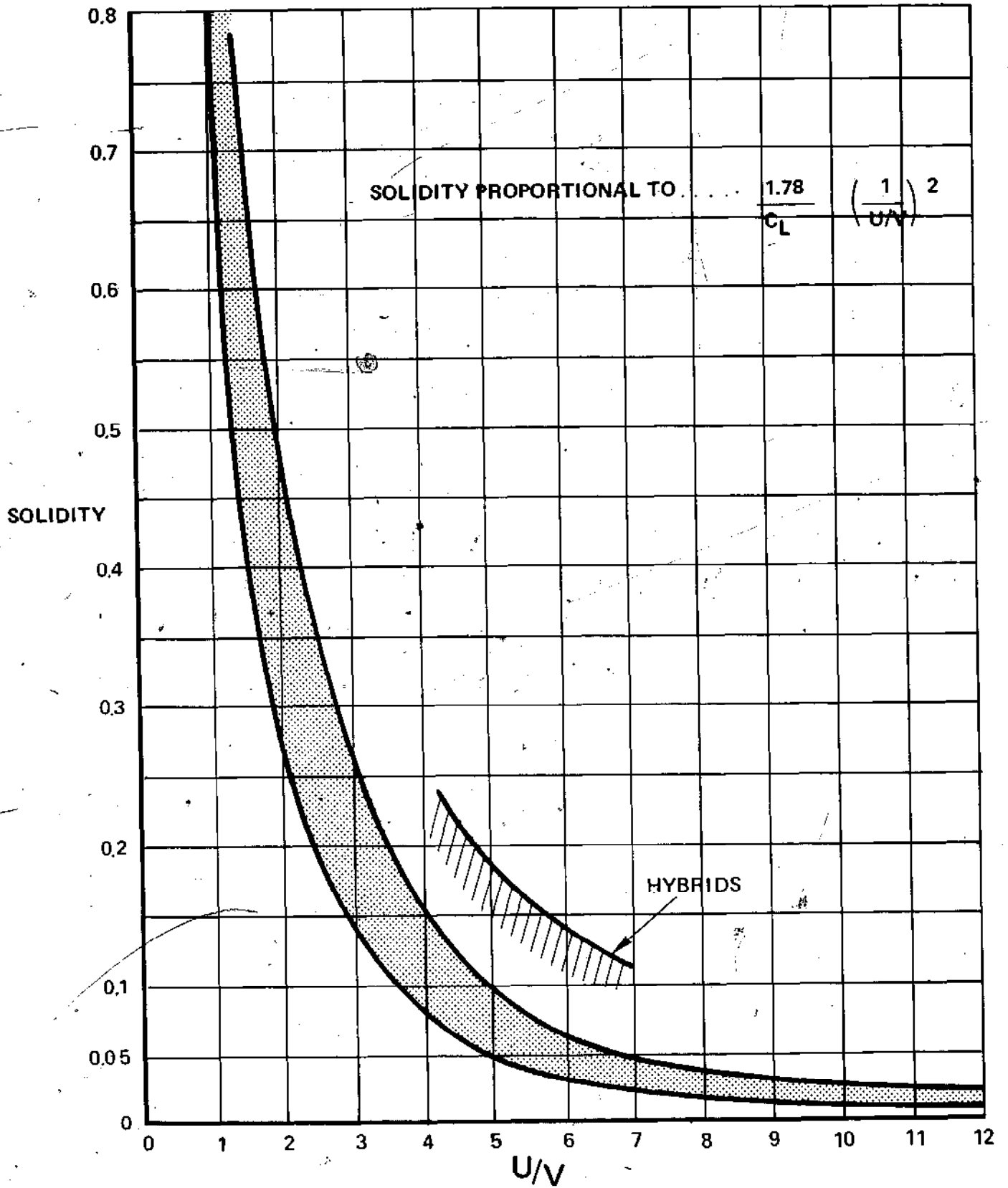
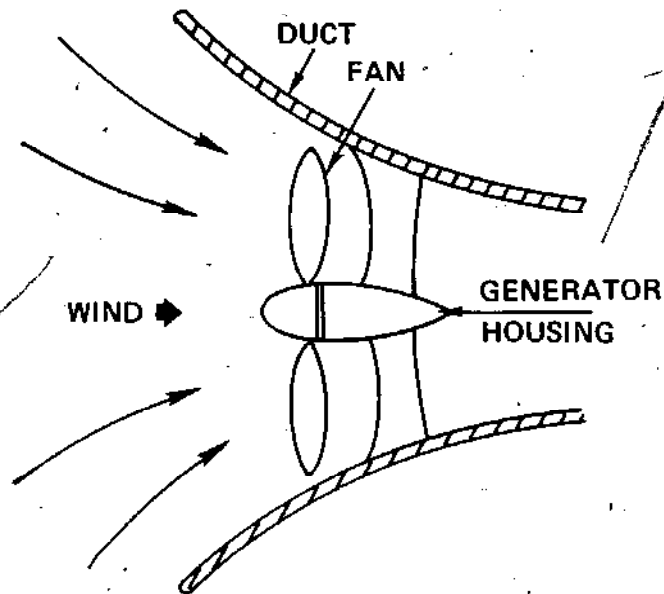

CHART E (see Equation 5)

WINDMILL AUGMENTATION

The idea here is to enclose the fan in a tube which is designed to speed up the airflow through the fan, and increase power output.



natural low pressure "suction" inside the duct to "suck" air through a windmill as illustrated.

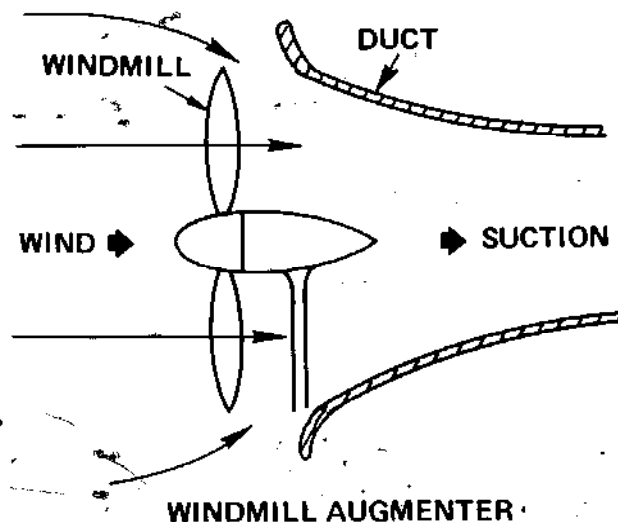

Certain design factors ought to be considered before you build a ducted fan windmill. First, the fan represents a blockage of airflow since it removes energy from the airflow. If air flowing into the duct is confronted with a blockage, it will probably go elsewhere - not through the duct. Slowed down air which has passed through the fan tends to "pack-in" behind the fan, and further hinder natural airflow through the duct. Some experimenters have found that a simple windmill which has the same diameter as the large duct around a smaller fan is the best design compromise. The larger windmill without a duct can usually generate as much power as the smaller enclosed fan.

The duct principle can be used to improve the performance of an ordinary windmill by using the

If you happen to have a nice windy canyon where you plan to install your windmill, you might rent a dozer and reshape the canyon to accelerate airflow through your machine and increase the usable wind power. This is topographic modification, actually another form of windmill augmentation.

If you're designing a Savonius Rotor for installation in a region where the wind blows mostly in the same direction you can augment this machine with sheets of plywood, concrete blocks, sail cloth, or whatever is handy, as illustrated in Figure 14.

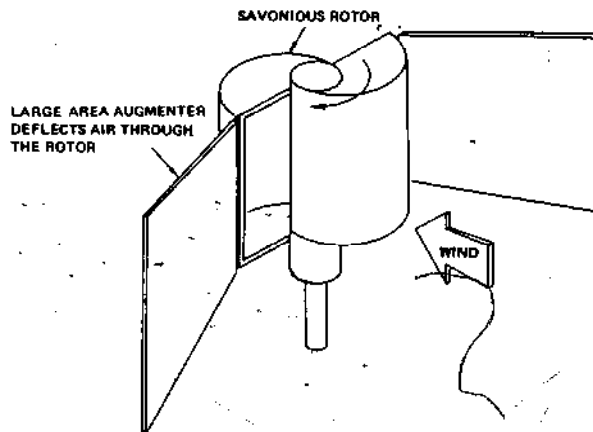

Figure 14

EXAMPLE

The following example is given for illustration and is not necessarily practical as a typical windmill design.

PRELIMINARY DATA

1. Power requirement = 10,000 watt-hours per day x 30 days equals 300 kilowatt-hours per month.
2. Wind available = 12 miles per hour average for 5 hours per day.

PROBLEM: To design a windmill which will provide necessary power. Assume that a storage battery system is included in the design.

SOLUTION STEPS

1 - 300 kilowatt-hours / 5 hours = 60 kilowatts (this is the power the windmill must generate - 60 kilowatts in a 12 mile per hour wind).

2 - Horsepower = $P \times A \times E$ (Equation 1)

and

Watts = Horsepower x 746

then

Watts = 746 x P x A x E

From CHART B - for $V = 12$ miles per hour, $P = 0.012$

Then: $\text{Watts} = 746 \times 0.012 \times A \times E$

3 - It is intended to select a high efficiency windmill for this design. Checking Appendix A, we find that efficiencies (E) as high as 0.4 (40%) are available from the hybrid design such as an "Eggbeater." For conservative design, we select $E = 0.25$ at $u/V=6$.

4 - $\text{Watts} = 8.95 \times A \times 0.25 = 2.24 \times A$

Since watts required = 60,000, then:

$60,000 = 2.24 \times A$. Then, $A = 26,785$ square feet.
This will be a large windmill.

5 - We have selected an Eggbeater for this example. An eggbeater looks approximately like a circle. It remains to calculate the circle's diameter, which is far larger than CHART C goes. We must use the formula on CHART C.

$\text{Area} = 0.785 \times D^2$

Most windmills will not require this formula. CHART C will suffice for most calculations. Therefore, I shall merely solve this equation with my handy pocket calculator to get:

Diameter = 185 feet.

For further illustration, had we assumed $E = 0.35$, then A would equal 19,169 square feet, and D would equal 156 feet, about 30 feet smaller. Let's continue with diameter = 185 feet.

6 - Checking CHART D for $u/V = 6$, we see that Solidity = 0.03 and greater. For a hybrid design, we select a value close to the hybrid line, say 0.1.

Then, Blade Area = $0.1 \times 26,785 = 2679$ square feet (from Equation 5)

7 - Since this is an eggbeater design with a circular shape and two blades, blade chord length will be easy to determine. Blade area = blade length \times blade chord, and blade length approximates the circumference of a 185 foot diameter circle. Circumference = $3.14 \times$ diameter = $3.14 \times 185 = 581$ feet.

Then, blade chord length = $2679 / 581 = 4.6$ feet.

8 - Since this is a vertical axis hybrid machine, no blade twist is needed, and blades must operate in different directions and lift on both sides of the airfoil. Therefore, a symmetrical airfoil such as the NACA 0012, or 0015 profile is indicated for this design.

Section C . . . STRUCTURAL AND MECHANICAL DESIGN

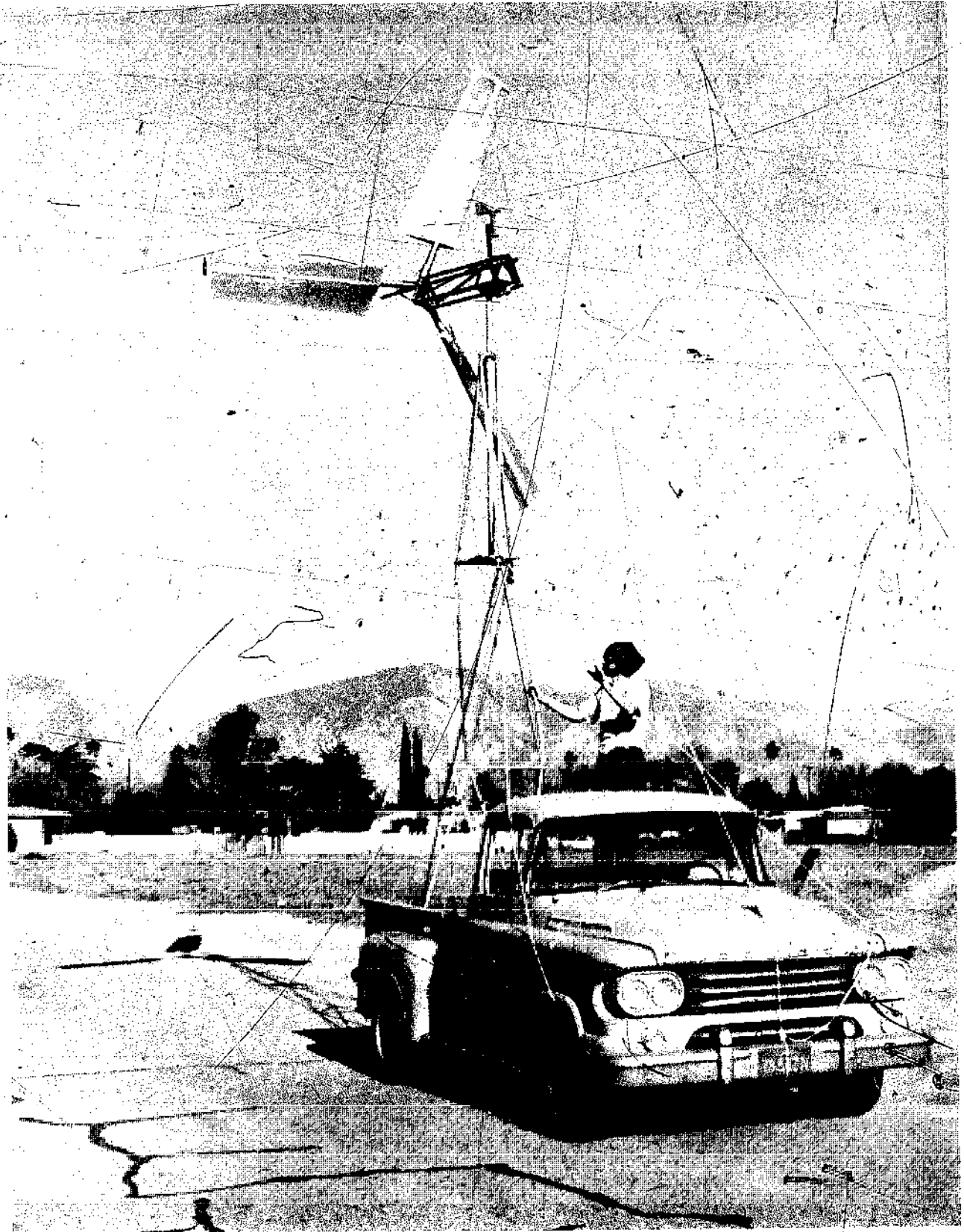

STRUCTURAL DESIGN

To simplify the design of windmill structures, it is well to understand the loads which try to break apart these machines. These loads are centrifugal force and blade bending. There are others, but of lesser importance.

CENTRIFUGAL FORCE

The first of these loads is centrifugal force which is the result of heavy objects moving rapidly in a circular path. These objects would rather, if given a chance, travel in a straight line. The strength required of the support which holds a windmill blade in its circular path, then, is determined by centrifugal force. Tie a rock to a long string and swing the rock around while holding onto the string. Centrifugal force keeps the string straight and tight.

The information you need in order to calculate centrifugal force on anything moving around in a circle is the speed of the object, radius of rotation measured from the center of rotation to the center of gravity of the rotating object, and the weight of the object. If the object happens to be a windmill blade, center of gravity is found by balancing the blade over the edge of a thin board, or by estimating its position during design. See Figure 15. With a windmill blade, you need to know u/V ratio at the radius of the center of gravity, and wind speed. Use the following formula to calculate centrifugal force on a windmill blade:

EQUATION 6

CENTRIFUGAL FORCE =

$$\frac{0.031 \times \text{WEIGHT} \times (u/V \times kV)^2}{\text{RADIUS}}$$

Where Weight = weight of the blade measured in pounds

u/V = u/V ratio at the center of gravity of the blade

V = wind speed

k = a constant to adjust V

if V is measured in miles per hour, k = 1.47

if V is measured in feet per second, k = 1.0

Radius = distance, measured in feet, from the center of rotation to the center of gravity of the blade.

EXAMPLE

A three-blade windmill is designed for a u/V(tip) of 6, and a diameter of 12 feet. Each blade weighs 5 pounds, with the center of gravity, determined from balance tests, at 3 feet from the center of rotation. Design wind speed = 10 miles per hour.

First: $u/V = 6 \times 3/6 = 3$

Then: CENTRIFUGAL FORCE =

$$0.031 \times 5 (3 \times 1.47 \times 10)^2 / 3 = 100.5 \text{ lbs}$$

Thus, the force which tries to rip a blade away from the hub of this spinning windmill is about 100 pounds in a 10 miles per hour wind.

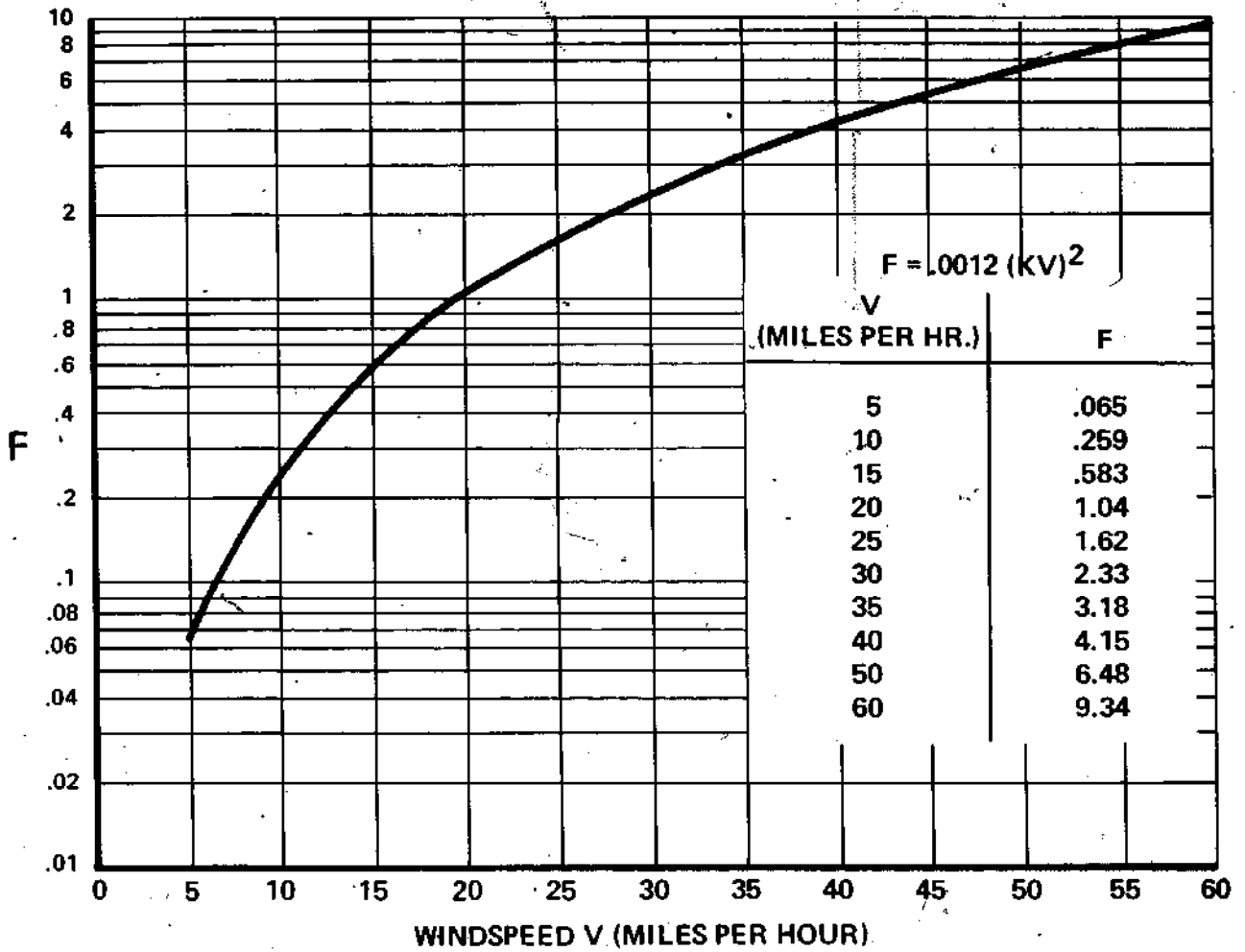

WINDSPEED V (MILES PER HOUR)

WINDSPEED FACTOR F

CHART F (for Equation 7)

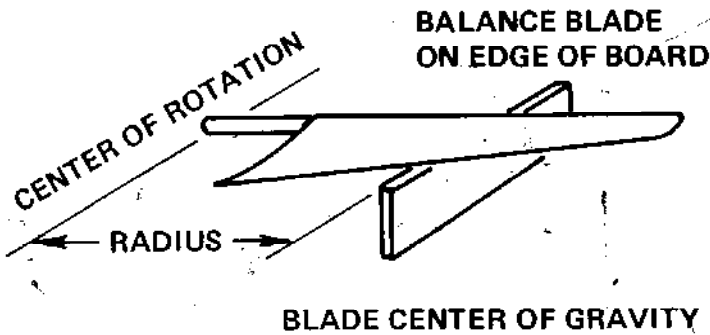

Figure 15

EXAMPLE

A windmill of 12 feet diameter is generating its rated power in a 20 mile per hour wind. Calculate windmill drag.

From CHART C, find that 12 feet diameter = 113.1 square feet. From CHART F, find that 20 miles per hour yields $F = 1.04$

Then: Windmill Drag = $1.04 \times 113.1 = 118$ pounds.

WINDMILL DRAG

Windmill drag causes support towers to topple, guy wires to break, and windmill blades to bend. Take the case of the high solidity multiblade water-pump type of windmills. Stand in front of one of these machines and what you see looks almost like a solid disk, with no place for wind to flow through. The higher the solidity factor, the more the windmill will look like a solid disk, and windmill drag will be higher. This is the case for non-rotating windmills.

In the case of a rotating windmill, drag is determined by how much horsepower is being extracted from the wind. A simplified, approximate formula for calculating windmill drag, which is a force measured in pounds, is:

EQUATION 7

$$\text{WINDMILL DRAG} = F \times A$$

Where F = windspeed factor -see CHART F

A = windmill frontal area measured in square feet, refer to CHART C.

EXAMPLE

The windmill in the previous example has a drag value of 118 pounds. This windmill has, say, three blades. The drag on each blade = $118/3 = 39.3$ pounds. This is the drag trying to bend the blade in the direction the wind is blowing, not to be confused with the aerodynamic drag on each blade which tries to slow down windmill rotation.

EQUATION 8

$$\text{Non-rotating blade drag} = 2 \times \text{Drag} \times \text{SOLIDITY}$$

Where Drag = rotating blade drag, measured in pounds (See Equation 7)

Solidity = the ratio of blade area to windmill frontal area, used in earlier windmill calculations. (See Equation 5)

EXAMPLE

A previous calculation showed, for a certain windmill in a 20 mile per hour wind, a blade drag of 39.3 pounds. This windmill was designed with a solidity of, say, 0.1. Non-rotating blade drag = $2 \times 39.3 \times 0.1 = 7.8$ pounds.

TORQUE

Torque is not really a force, but more precisely the result of a force which is applied a certain radius from center of rotation - a twisting force. Torque is measured in foot-pounds (or inch-pounds), and is the result of blade lift; torque causes windmill rotation against the load of the generator. Lower rotary speed windmills need higher torque values to generate a certain power output. Basically, torque multiplied by rate of rotation equals power.

If high torque is needed, but rotational speed is not so important, you would pick a windmill with a low u/V value, if slightly lower efficiency can be overlooked. High torque makes a windmill easy starting in mild winds. Lower torque, high speed machines, on the other hand don't start turning until the wind speed has risen, in some cases, almost to the design operating wind speed.

Torque causes blade bending (mostly at the root end), tries to shear the blade hub off the power shaft, and twists the power shaft. You can calculate the torque value for your design from the following formula:

EQUATION 9

$$\text{TORQUE} = \frac{3300 \times D \times \text{HP}}{u/V \times kV}$$

Where D = windmill diameter measured in feet

$$u/V = u/V(\text{tip})$$

V = wind speed

k = a constant to adjust V

if V is measured in miles per hour, $k = 1.47$

if V is measured in feet per second, $k = 1.0$

HP = windmill horsepower (the output of the blades - not the generator being driven by the blades)

Torque = windmill shaft torque measured in inch-pounds

EXAMPLE

A 12-foot diameter windmill generates 3 horsepower at $u/V = 6$ in a 25 mile per hour wind. From Equation 9, we can calculate shaft torque = 539 inch-pounds.

SAFETY FACTOR

Your windmill will likely be installed in an area where safety to things both living and not is a primary consideration. We have seen that it is possible to be conservative in the design of the windmill as a guarantee of performance. Consequently, structural design is mandatory for safety reasons.

The methods presented for calculation of centrifugal force and windmill drag, the two primary loads, are approximate in nature, and in most cases, somewhat conservative. Designers usually multiply calculated loads by a factor of safety to further improve structural reliability. A value of 1.5 is common in load calculations.

EXAMPLE

A windmill blade has a centrifugal force of 100 pounds in a certain wind. Using the factor of safety, calculate the design centrifugal load.
 Design centrifugal load = $100 \times 1.5 = 150$ pounds.

LOAD CONDITIONS

Condition 1. The windmill is spinning in a certain wind under generator load. The loads on the windmill in this case are mainly windmill drag and centrifugal force. Look at Figure 16 to see these loads.

Notice that centrifugal force stretches, or causes a tension load in the blade, while blade drag bends the blade: As the blade bends (just a little), the tension load is moved away from the plane of rotation. Plane of rotation is the imaginary flat disk the blades make as they rotate. The tension load will try to bend the blade back to its plane of rotation, thusly offsetting blade drag. From this, we can see that centrifugal force is the main load to design the blade for during Condition 1.

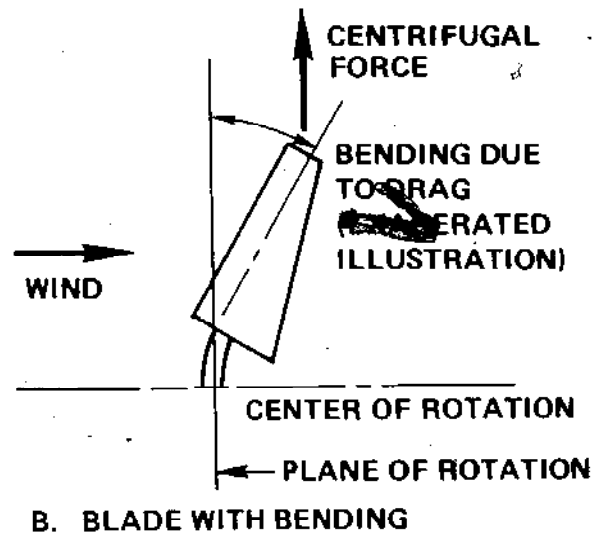
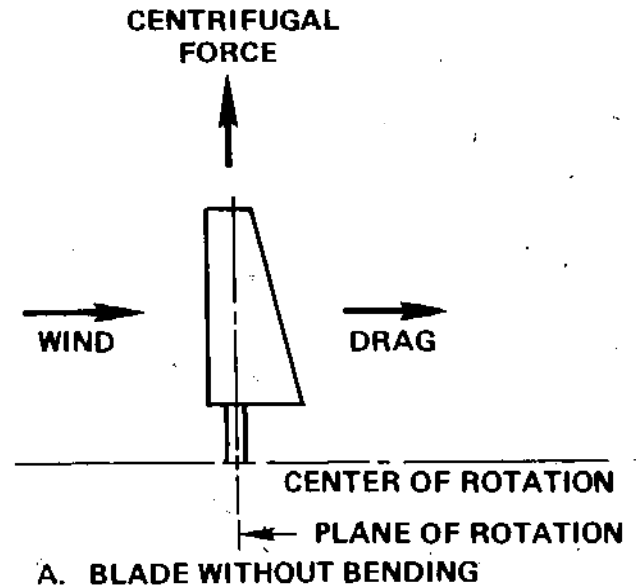

Figure 16

Condition 2. The windmill is turning in a certain wind with no load. Again, centrifugal force is the main load, but it will be considerably higher. This case calls for calculating centrifugal force at a $u/V(\text{tip})$ ratio as much as 50% higher than the windmill is designed for.

EXAMPLE

The previous example calculation for centrifugal force started with a $u/V(\text{tip})$ of 6. For the free spinning windmill, start calculation with $1.5 \times 6 = 9 = u/V(\text{tip})$.

Normally, Condition 2 loads are calculated at very high wind speeds, the highest you would expect in the area the machine is to be installed. Wind speeds of 60 to 100 miles per hour are not uncommon. If the centrifugal force caused by Condition 2 is greater than you can build the windmill strong enough to withstand, a speed limiting device, like a brake, or aerodynamic drag flaps on the blades must be installed to hold the rotational speed down to acceptable values.

EXAMPLE

Using the previous centrifugal force problem:

Normal condition: $u/V(\text{tip}) = 6$, radius = 3 feet, blade weight = 5 pounds. Condition 2: $u/V(\text{tip}) = 1.5 \times 6 = 9$, wind speed = 60 miles per hour, and $u/V = 9 \times 3/6 = 4.5$

Then, centrifugal force = $0.031 \times 5 \times (4.5 \times 1.47 \times 60) (4.5 \times 1.47 \times 60) = 24,417$ pounds.

We shall soon see how to convert the centrifugal tension force into blade material and size requirements, but for now, if we

assume that this 24,417 pound load is too large, a speed limiting device must be constructed to limit $u/V(\text{tip})$ to a smaller value.

Condition 3. The windmill is locked so it cannot rotate, and a wind is blowing. Here, the main force is drag. We have seen that blade drag -the kind that topples support towers on extremely windy days -causes the blade to bend. Review Figure 16. Thus, another load to design for is bending. Generally, if the windmill can withstand overspeed (Condition 2) loads it is strong enough to take Condition 3 bending loads. You can check blade bending loads for the non-rotating case by using Equation 8.

BLADE STRENGTH

We have just seen how to calculate blade loads. Now, let's determine blade strength, which is the ability of the blade to withstand the load without breaking. First let's look at a few methods by which a blade can be built. The structural design of a blade, and the materials with which it is made determine blade strength. The blade must be designed to take centrifugal tension and bending. It must retain the airfoil shape and twist, and remain firmly attached to the hub. Several ways exist to accomplish all of these design tasks. Here are a few of them.

1. Solid, or partially solid carved wooden blade with bolted steel or aluminum hub attachment. Wooden blades can be "skinned" with fiberglass and resin for improved protection.

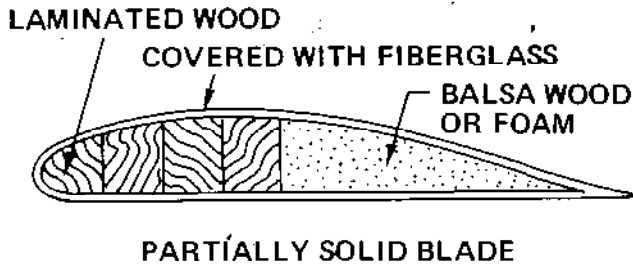
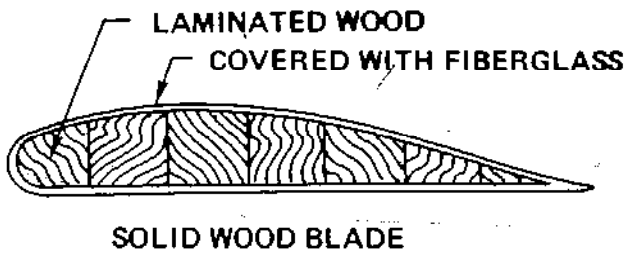

2. Tubular spar, with foam, balsa wood, or honeycomb, or other filler, covered with fiberglass and resin. The spar can be made of aluminum, steel, or stainless steel.

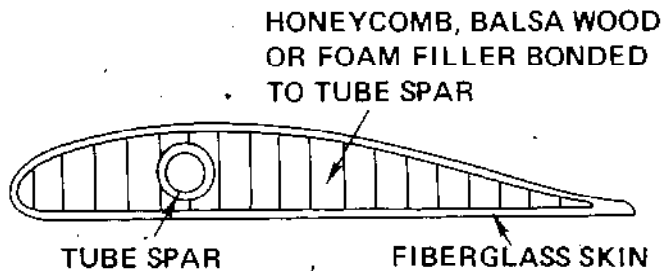

3. Tubular spar, with metal ribs and skin.

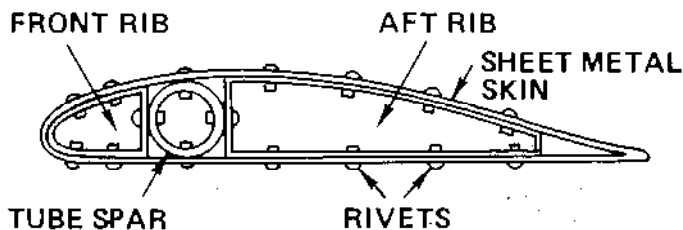

The usual material for this design is aluminum, but you will have to be careful in planning this type of blade to get the skin to take both the curvature of the airfoil, and blade twist. Try constructing a test blade with paper. Rivets and epoxy bonding will attach the skin, ribs, and spar together. Rivets may be aircraft aluminum, or steel "pop-rivets".

4. Tubular spar, with molded fiberglass skin.

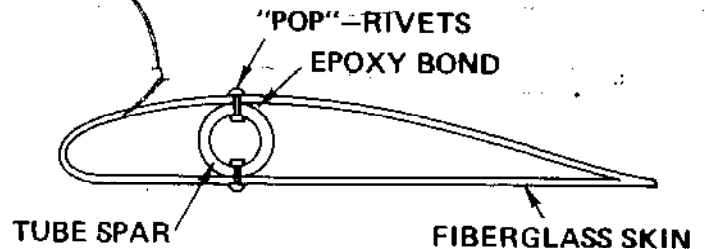

A few foam ribs may be bonded inside the fiberglass, but in any case, the fiberglass skin will be four to eight laminations thick, and must be strong enough to avoid flexing in strong winds.

5. Sailing construction will make fine, economical blades.

CONSTRUCTION METHODS

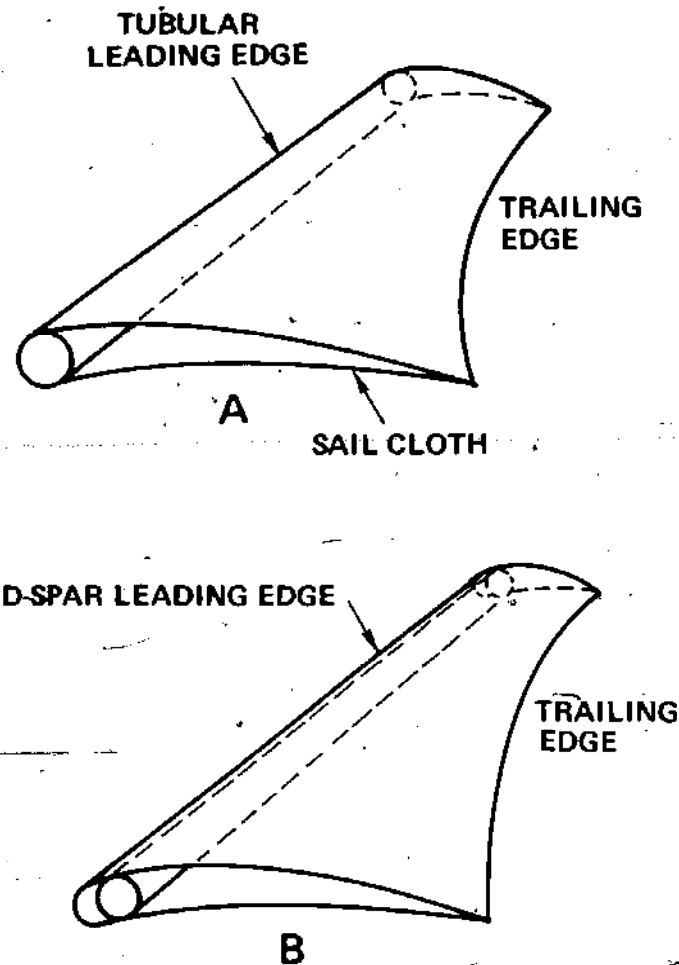

These blades are easily made with a tube spar, a stretched cable trailing edge, and a plasticized fabric (the fabric pores are sealed against air leakage) membrane. The membrane changes curvature in response to changing airflow, and thus generates high lift quite efficiently. The membrane must be stretched fairly tight for best performance. An ideal membrane can be made from the light weight nylon fabric that backpacking tents are made with, or extra light sail cloth, as used on hang gliders.

First, the carved wood method uses construction skills which are not new to experimenters. Carving wood is easy, fun, and very rewarding. Wood, however, is not necessarily the best material with which to build a windmill. It's true that wood is the most readily-available, replaceable resource, but wood soaks up moisture and it is mighty difficult to prevent this from happening. If one blade soaks more water than another, it's easy to see that an out-of-balance condition will result. You can calculate the result of this by changing the weight of one blade in your practice calculations for centrifugal force. In the overspeed condition, out-of-balance is liable to cause the windmill to shake itself to death. If, on the other hand, you will take care to keep the wooden blades sealed, this is a great way to build a windmill.

As a result of the Hans Meyer plans for a windmill printed in POPULAR SCIENCE, lots of people are building windmills with Method 2, a tube spar inside a paper honeycomb filler, skinned with fiberglass. While honeycomb is somewhat expensive this method is an easy way to build experimental blades. The skills required to work with honeycomb and fiberglass are easily learned and the results of your efforts are strong, high-performance blades.

The rivetted aluminum structure yields a blade which is strong, light weight, and which will last a long time. The skills of rivetting, drilling, metal forming and bonding are easy to master.

TUBE SPAR DESIGN

We know that blades must be strong enough to withstand tension loads from centrifugal force and bending. What follows is a simplified method of calculating a tube size (diameter and wall thickness) and material (steel, aluminum, stainless steel, etc.), which will withstand these loads. Figure 17 illustrates the properties of a tube for our calculations.

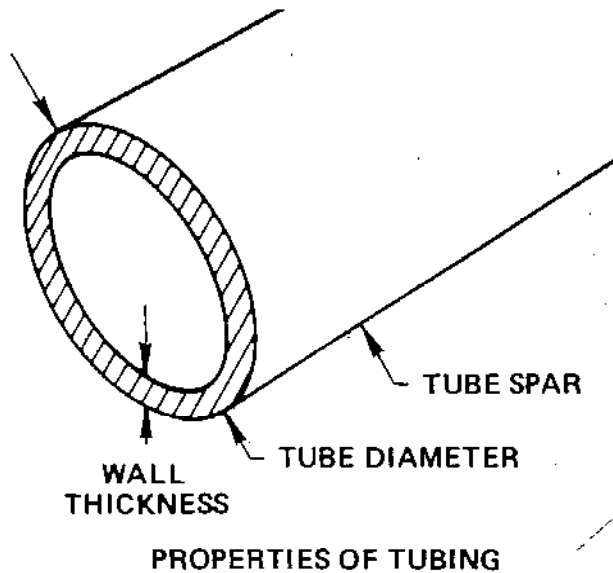

Figure 17

Centrifugal tension is the main load, as we have discussed. When you have calculated centrifugal force, simply use TABLE A in Appendix E to find a tube size which can withstand the centrifugal tension you have calculated. This tube will likely be strong enough for the bending loads but bending strength should be checked, too. To convert blade drag into blade bending, use the following formula:

EQUATION 10

$$\text{BLADE BENDING LOAD} = \text{Blade drag} \times \text{radius} \times 12$$

Where Blade drag was previously determined in pounds of force

radius = distance measured in feet to the center of the blade from rotation center

EXAMPLE

Windmill diameter = 12 feet
Blade drag = 10 pounds
Blade bending load =
 $10 \times 12 \times 12/4 = 360$ inch-pounds

Using data methods presented in Appendix E, you can select a tube size which is strong enough to take the bending load.

FATIGUE

You can break a strip of, say, aluminum two different ways. The first is simply to pull it apart with one giant load. The other method is more subtle; here you apply a small load, let it relax, then apply the load again. Do this repeatedly until the metal cracks, then fails. You have caused a fatigue failure.

Now, wood does not fatigue. Theoretically, you can repeatedly apply loads to wood and it won't crack. Wood might, however, crack and splinter from a number of environmental factors, but wooden blades in general are not subject to fatigue. Metallic or fiberglass structures in a windmill are subject to fatigue.

One way to prevent fatigue failure (which claimed the life of one of the blades on the Smith Putnam windmill) is to keep the loads low in relation to the structural strength. This is the basis for conservative structural design.

Basically, we have considered structural design as a simplified approximate problem. If you wish to pursue structural design to an exact level -which I recommend - check the bibliography in this text for an excellent reference on this subject.

STRUCTURAL DESIGN OF VERTICAL AND HYBRID WINDMILLS

Structural design of vertical axis machines such as the Savonius Rotor involves making the machine strong enough for centrifugal force. The tower and support structures must be strong enough to prevent toppling over in high winds.

Hybrids, which are vertical axis machines using high-speed, high efficiency airfoil blades will have structural centrifugal forces and blade bending. In this case, blade bending is caused by centrifugal force. Refer to Photo 3 and Figure 18 to visualize this bending force for one example of a hybrid machine.

Figure 19 shows blade bending due to centrifugal force in another type of hybrid machine. Blades can be made strong enough for bending by using cable supports to the tips, or centers of these blades.

These cables can be stretched between two blades, which is the case for the hybrid-V, or between blades and hub structure as illustrated in Figure 20.

SUPPORT STRUCTURES

Complete windmill design involves planning the support structure. This structure can be as simple as a short pipe, or as complex as a cable supported tower. Two loads must be supported by your tower: the weight of the entire windmill assembly, and the total drag, which includes windmill drag and tower drag. As an approximation, simply double the windmill drag load to get the total. The guy wires you use must support these drag loads.

The tower must be rigid. Any flexibility will result in less efficient windmill operation, particularly in the case of vertical axis machines.

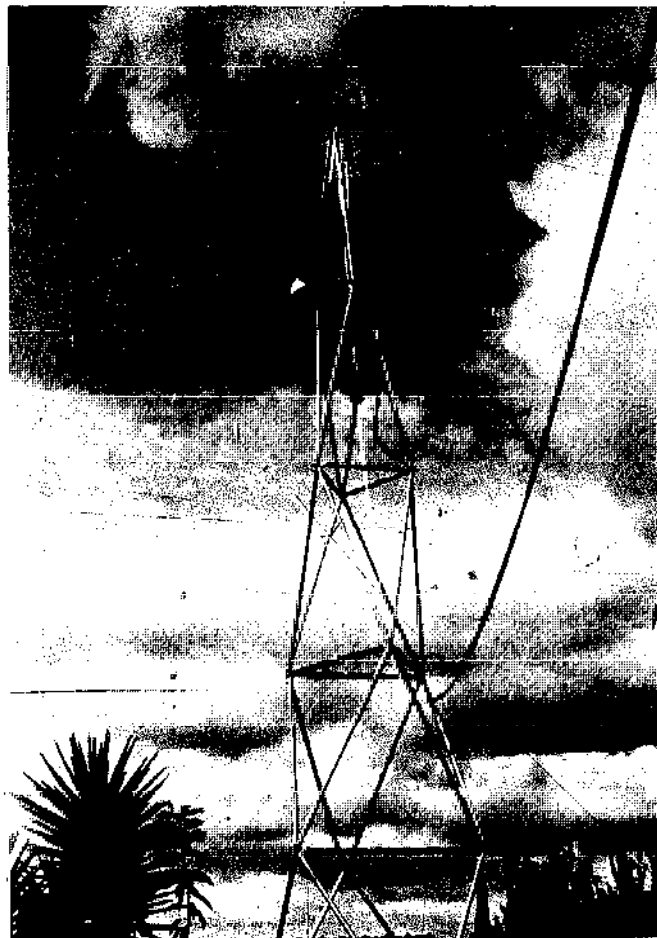

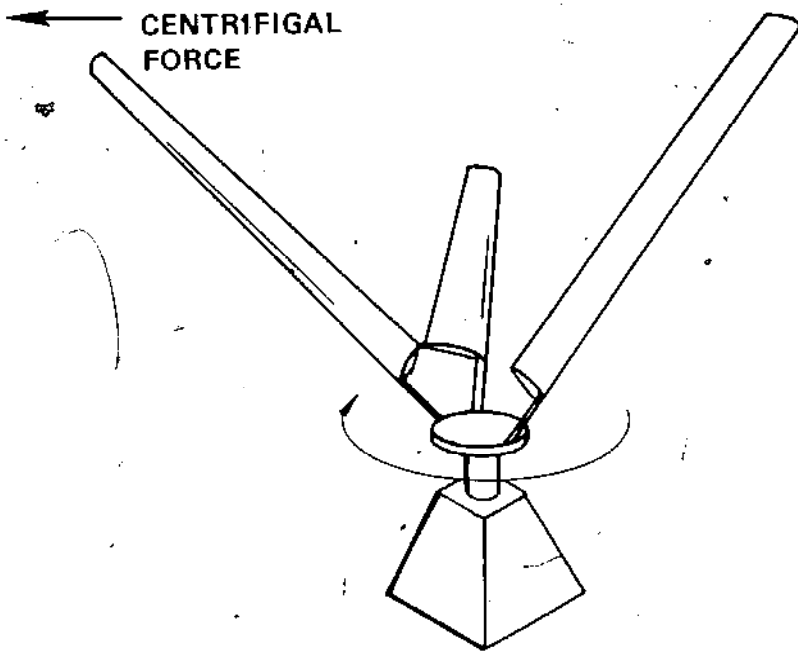

CENTRIFIGAL FORCE/BLADE
BENDING OF HYBRID WINDMILLS

Figure 18

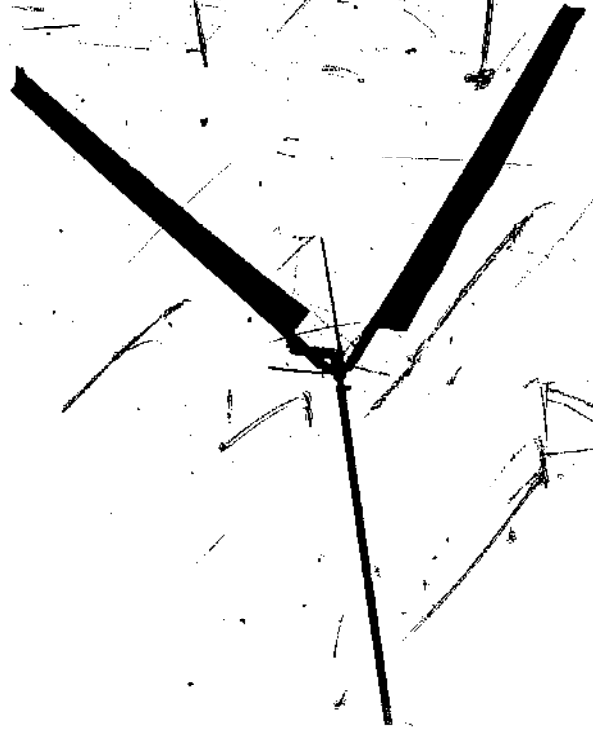

Photo 3 Hybrid-V Prototype

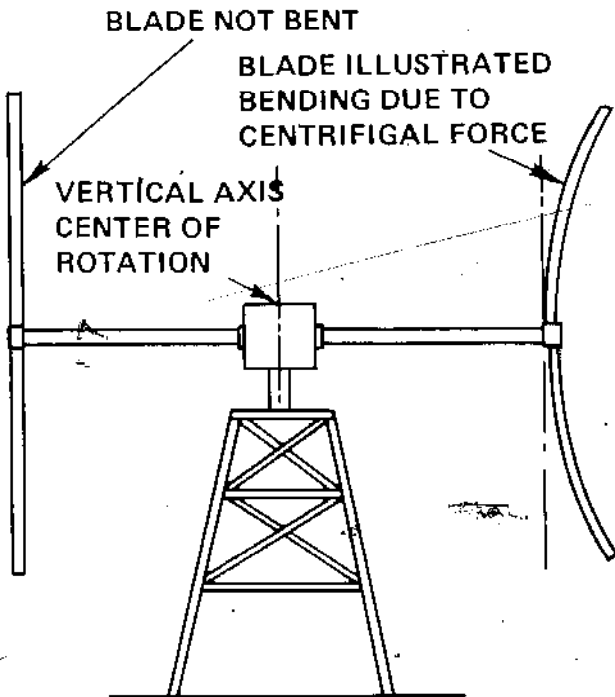

Figure 19 Hybrid Loads

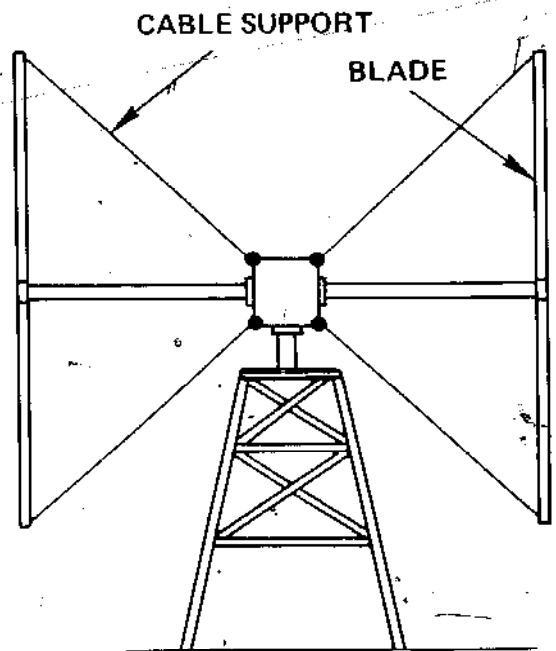

Figure 20

MECHANICAL DESIGN

Problem: To control windmill speed in gale winds.

Solution: There are several. The solution you arrive at depends on the windmill, the expected strength of tempest winds, and your ingenuity. Here are a few solutions already used:

A- Aiming the windmill out of the wind, two ways: turn it sideways, or tilt it up. See Figure 21.

B- Coning - allowing the blades to form a cone in the downwind direction which reduces the frontal area, thus reducing the power and rotary speed. Blades can be freely hinged with, perhaps, a small spring to hold them out for strating. Centrifugal force holds them out during normal rotation, but tempest winds increase blade drag and cause coning. See Figure 22.

C- Centrifugal safety brake, a cheap go-cart centrifugal clutch can be driven by the windmill. Whenever rate of rotation speeds up to a certain point, the clutch will try to engage. If you prevent the clutch output shaft from turning (with bolts or welding) the device will act as an over-speed brake and prevent windmill destruction. You can drive the clutch (brake) with the same gear or pulleys which drive the generators or pumps. This system will work with any type of windmill.

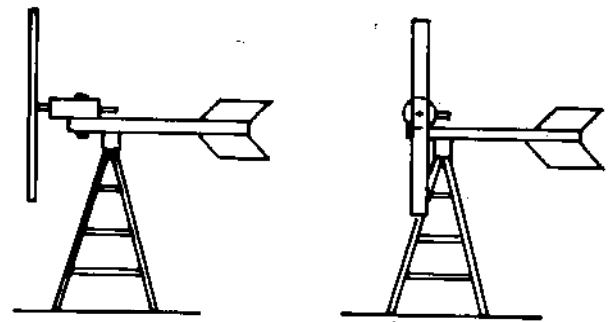

A

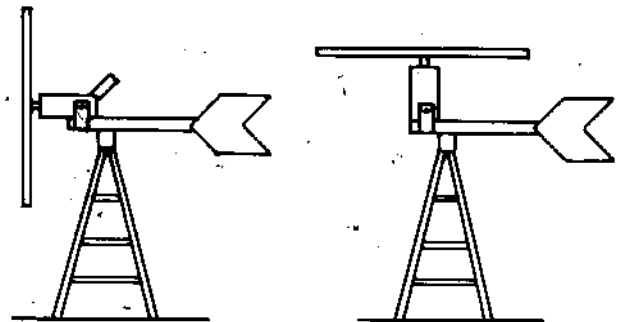

B

Figure 21 Windmill Aiming

D- Aerodynamic control - this is the method of power control which receives the most design attention. You can accomplish power control by "blade pitch control" which means rotating the blades to change the blade angles to reduce power. For blades made with tube spars you only need to mount the tubes in bearings at the hub so that the blade angles can be changed, then provide some means of controlling this angle.

The method most used in small installations to control blade angle is to mount a fly-weight on each blade. See Figure 23. The fly-weight tries to swing into the plane of blade rotation, against the return spring, thus controlling blade angles.

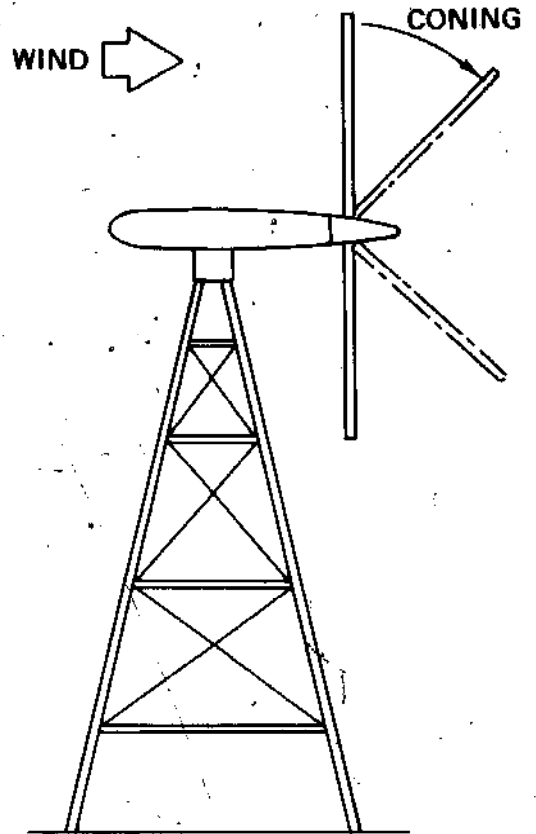
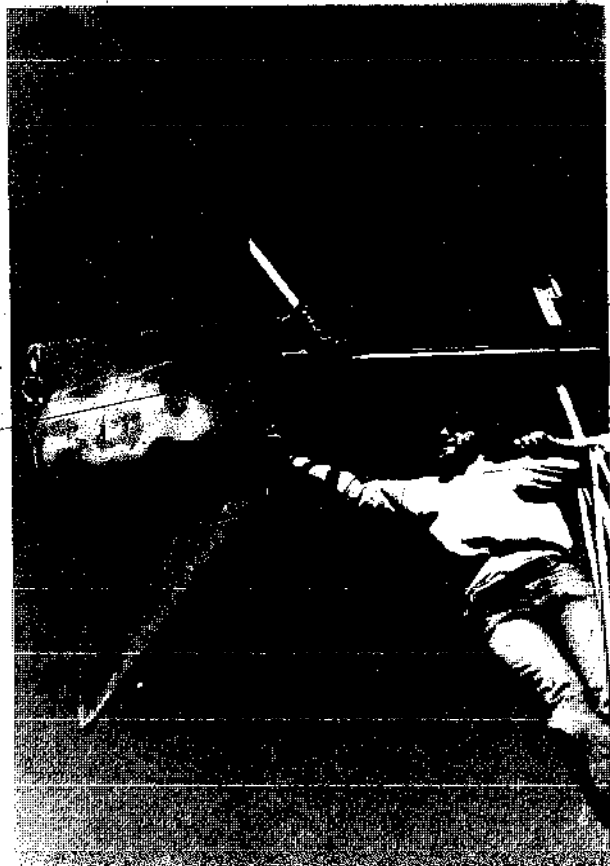

Figure 22 Windmill Coning



Another version of centrifugal control involves allowing the tube spar to slide in-and-out of the hub, and rotate. A strong spring holds the blade in against normal centrifugal force, but excessive rotary speed increases centrifugal force and overcomes spring tension. The blade slides outward, but is caused to rotate by means of a spiral cam groove or slot. See Figure 24.

One further version of aerodynamic control is to use blade drag to cause the whole blade hub assembly to slide downwind on the power shaft. A spring holds the hub against its normal motion stop, but when wind caused drag is high enough the hub compresses

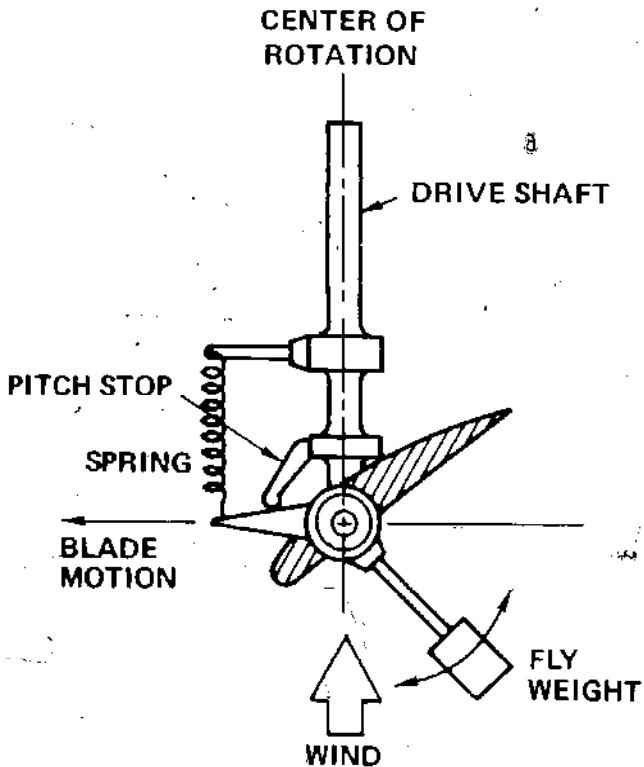

Figure 23 Flyweight Control

the spring and slides. Linkages hook the blades to a non-sliding portion of the hub or power shaft so that as the hub slides, blades are caused to rotate as the linkages extend. See Figure 25.

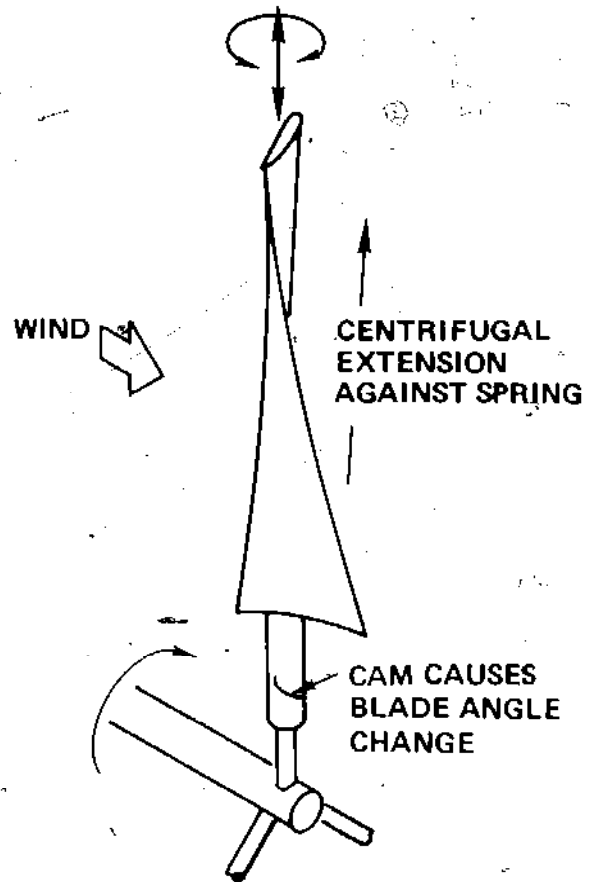

Figure 24 Sliding Blade Control

Aerodynamic drag can be used to control windmill speed. By mounting flat-plate drag brakes as illustrated, centrifugal force may be employed to actuate these plates. By adjusting spring tension and actuation geometry small plates at the tips of the blades can be made to absorb more power than the blades can generate, and thus limit, or control windmill speed and output.

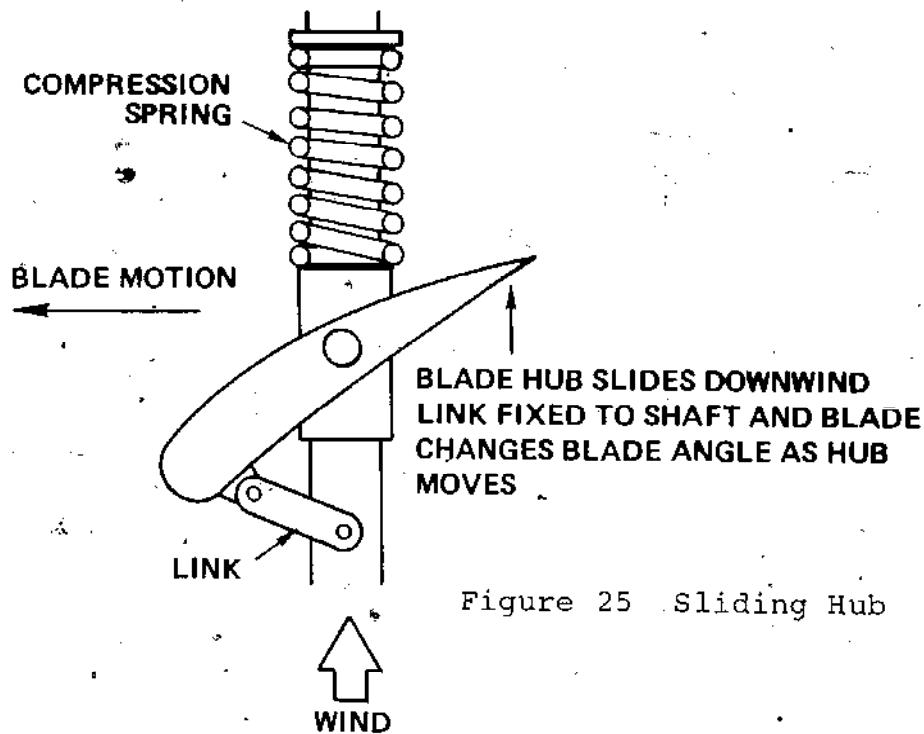
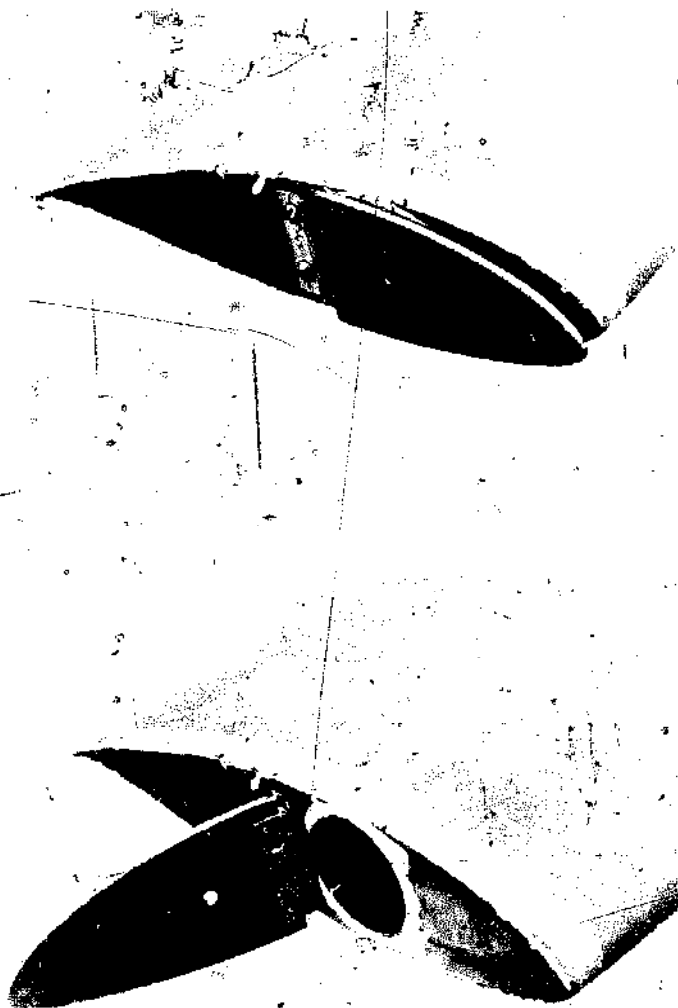

Figure 25 Sliding Hub



It should be noted that with any of the methods discussed here all blades and blade control devices must be linked together so that all blades react together. Any time one blade geometry is permitted to vary from the configuration of other blades during high-speed rotation, severe vibration and balance problems will set in immediately. The results of this are usually catastrophic. Link all blades or controls together.

Problem - To control windmill direction to keep the machine aimed into the wind.

Solution - If your windmill is a vertical axis, or hybrid machine, you have no problem at all, for these designs are always aimed into the wind.

For horizontal axis machines, however, the problem exists. The solutions are obvious; some of them simple.

A-Tail feathers. Look at Photo 4. The tail-mounted fin acts like an airplane's rudder to keep the windmill aimed into the wind.

Types of vanes used are illustrated in Figures 26 A, B, and C. Design A is a bit of nostalgia, but it works. Design B is a great improvement, and C is the best. The reason is simple. You want the tail vane which is most sensitive and responsive to changes in wind direction. Design C has the highest ratio of vane span, which is the distance from top to bottom on the vane, to vane chord the distance from leading edge to trailing edge. Such vanes are like glider wings which are designed to make the most use of light up-drafts to support these craft aloft without benefit of a motor. Practical ratios of span divided by chord for the vane might be between two and ten. In other words, a typical vane might be five times as tall as it is wide.

B - Tail mounted blades - mounting the windmill blades behind the directional pivot works fine. Blade drag acts to keep the windmill aimed correctly. If you design a windmill of this type, balance the machine to be slightly heavier in front of the directional pivot. Do this by mounting generators, batteries, or other heavy things up front. This serves to help dampen out any "hunting" tendency in the windmill. Tail mounted blades are required if you plan to use coning for gale wind protection. With tail mounted blades comes one small problem: the turbulent air-flow behind the tower causes the blades to vibrate as they pass



Photo 4

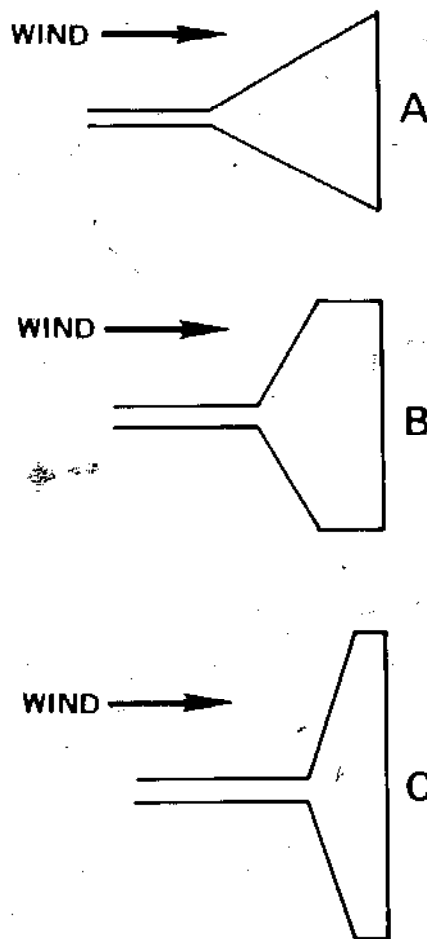

Figure 26 Tail Vanes

behind this area. This vibration can enhance fatigue problems, and should be reduced by streamlining the tower in the blade region.

Problem - Your windmill doesn't turn fast enough for the generator you want to use.

Solution - Gears or pulleys and belts to increase the speed. Gears are great, but expensive, and they require a box to house them and their oil or grease. Some experimenters have recycled automotive "rear ends" complete with gear trains inside for such purposes. Bicycle chains and sprockets can be recycled from junk parts. Pulleys and belts of all types are available but automotive V-belts should be avoided because of high belt friction and slippage problems. Cog belts, while expensive at first, last a long time and work well with low friction.

The starting point for any design is to calculate the gear ratio you need.



Chain Drive

EXAMPLE

Your windmill has a rotation rate in a mild wind of, say, 300 revolutions per minute. The generator you plan to use begins to generate electrical current at, say, 600 revolutions per minute, and really puts out the power at 900. You choose to match the generator at 900 to the windmill at 300 since your calculations already show that the windmill can deliver the required power at this rotation rate.

Then $\text{GEAR RATIO} = 900/300 = 3 \text{ to } 1$

This means that the pulley or sprocket doing the driving (at the windmill) will have to be three times the diameter of the smaller driven pulley (at the generator). Some windmill designs may need ratios as high as 10 to 1.

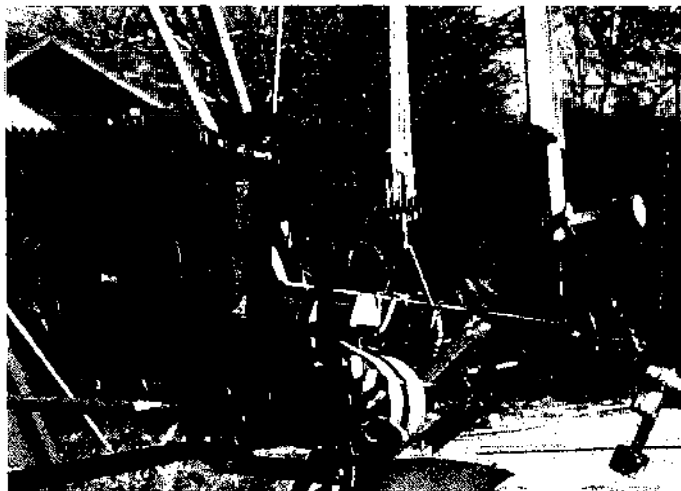

Cog-belt Drive

DESIGN Section D . . . POWER SYSTEMS

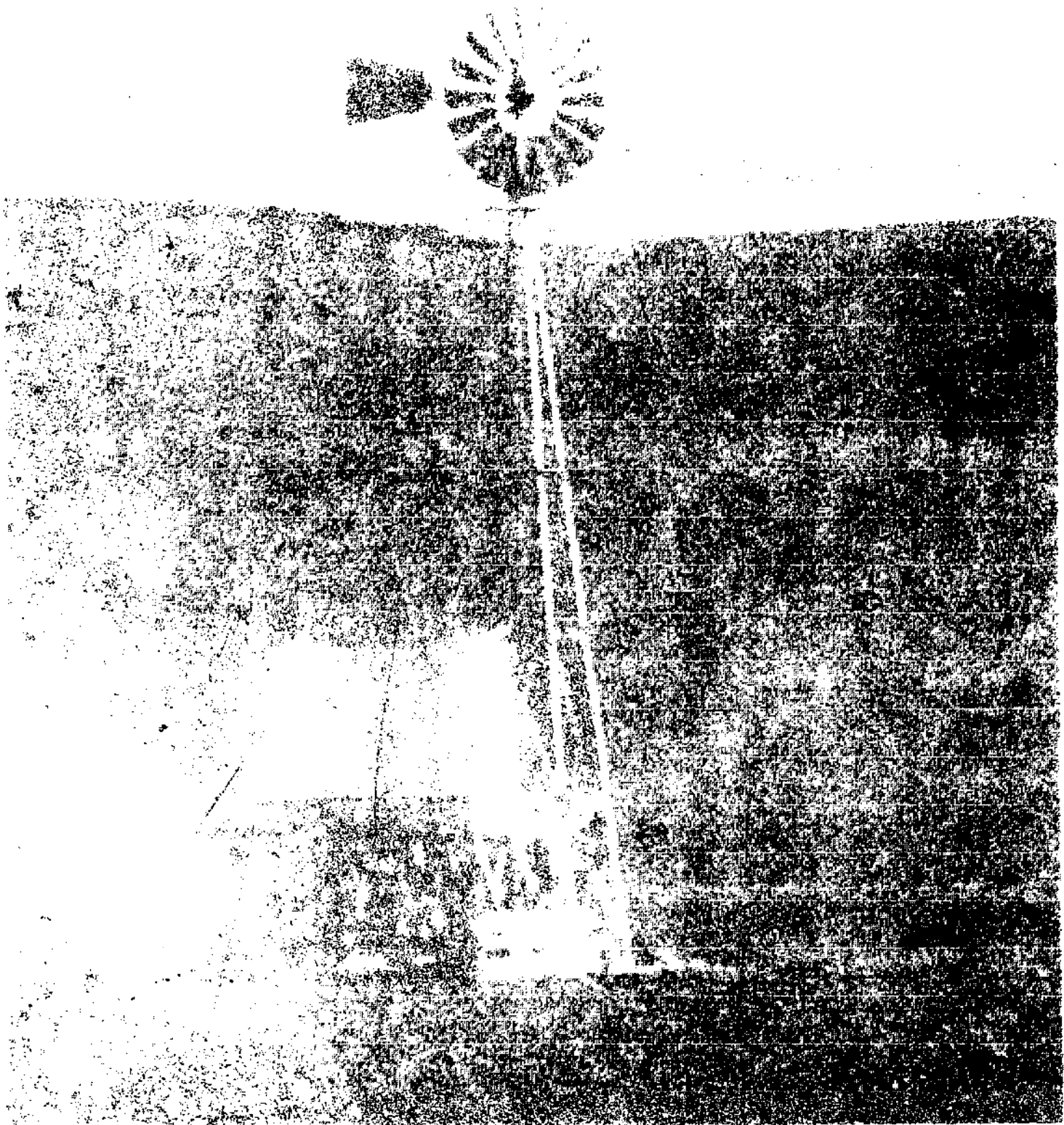

Consider the fact that man himself as a means of mechanical power can contribute only about one horsepower hour of work in any given day. When energy is made available to relieve man from using only his own power in performing useful tasks real progress is made.

Conversion of energy, in a true alternative sense, ought not to contribute to the heat load of the earth as a whole. Wind energy is an obvious source of power which does not liberate energy in the form of heat not already in the atmosphere, since the prime mover of wind is solar heat.

It's an interesting fact that wind and solar heat are complementary in nature which allows practical utilization of these energy sources at a grass roots level. Tests have shown that, averaged over a five year period, solar energy peaks at about 28 watts per square foot of collec-

tor surface in July, and drops to about 9 watts per square foot in January, while wind energy peaks at about 35 watts per square foot in February, and drops to about 7 watts in August - depending on where you live. Thus, the two sources can provide a reasonably constant amount of power when used together.

The point to remember about the two energy sources, used together or separately, is that there are short-time variations in power available. Thus, energy storage is required to guarantee power availability when needed. A windmill installed in an area of virtually constant winds (mountain passes, and some beach areas, for example) will likely not need extensive energy storage, while a windmill in areas given to extended periods of no wind need large storage systems, or other energy sources. Figure 27 illustrates the elements of a complete power system.

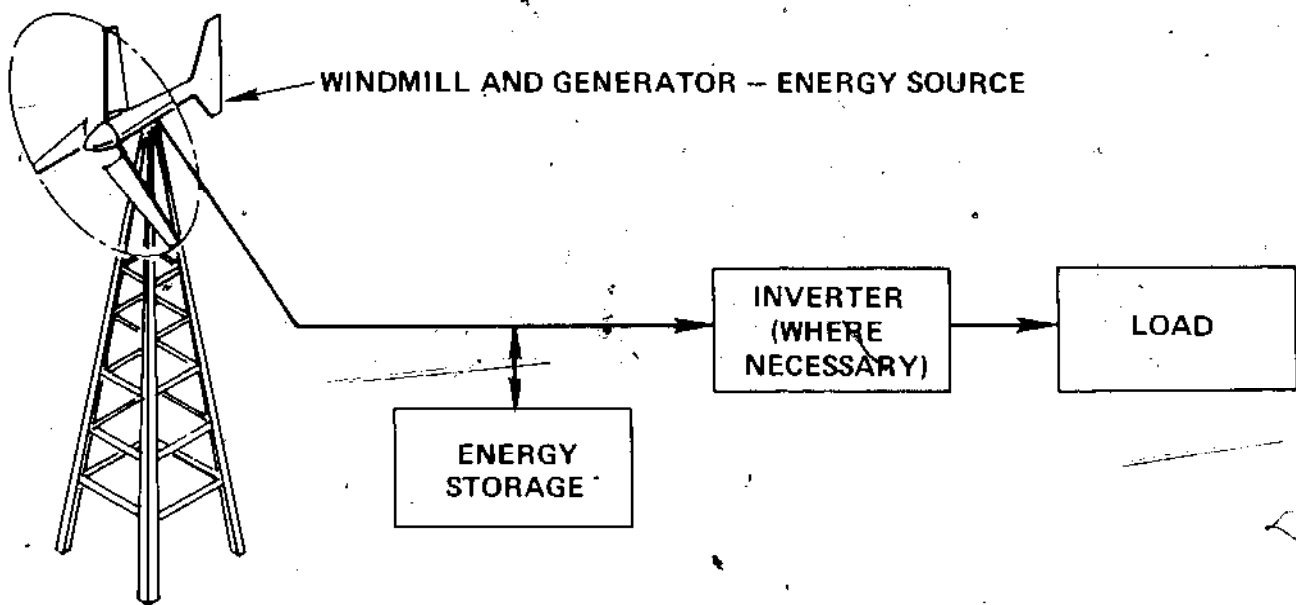

COMPLETE POWER SYSTEM

Figure 27

ENERGY STORAGE

Four possible systems will be discussed here. These are:

1. Storage Batteries
2. Fuel Cells
3. Flywheels
4. Pumped Water

An ideal wind power system would use combinations of these storage systems. For example, on windy days when an excess of energy is available the batteries will be charged to their full storage capacity. When the batteries are charged a simple switching device might divert electricity to a water pump to store water as will be discussed shortly. In any case no single method of energy storage is ideal.

STORAGE BATTERIES

Storage batteries are common and readily available. Automotive batteries are perhaps the most common units today. These units are designed with low manufacturing cost as a prime consideration; weight and storage capacity are of secondary importance. However, because of availability and cost, some experimenters may be able to secure enough of these second-hand at give-away prices; the cost per watt-hour of storage will be low enough to make their use worthwhile.

Watt-hours of storage capacity is the key to battery selection. Batteries are usually rated in ampere-hours. Note that the ampere is usually called an amp, which is a unit of electrical current flow, and the following formula can be used to calculate watts:

$$\text{WATTS} = \text{Amps} \times \text{Volts}$$

or

$$\text{WATT-HOURS} = \text{Amp-hours} \times \text{Volts}$$

EXAMPLE

For a 12 volt automotive battery which is rated at 60 amp-hours, Watt-hours = $60 \times 12 = 720$.

Now if the power required estimate (from earlier windmill calculations) indicates a requirement of, say, five kilowatt-hours per day (that's 5000 watt-hours) and the power available on a particular day from your windmill is three kilowatt-hours, a storage capacity of the difference, or two kilowatt-hours is needed. As much as the entire power requirement may be required, depending on the duration of the wind. If the battery to be used is capable of storing, say, 720 watt-hours, then 5000 divided by 720 equals 6.9, or seven of these batteries will be needed. However, if the entire storage capacity is used during a no-wind day, the batteries will be dead by the next morning, and auto batteries are not designed to be drained entirely very many times. One ought to, in the above example, double the number of batteries, or more, to prevent "deep-cycle" draining them.

Keep in mind also, that as batteries age, and especially in the case of free-for-the-taking variety of automotive units, storage capacity decreases. You might be lucky to store half the ampere-hours rated on the sticker on the side of these batteries.

Batteries that are designed for purposes more compatible with wind energy storage are used in electric golf-carts and recreation vehicles like motor-homes. These batteries are larger, and more costly than automotive units but their increased capacity and life may offset the hassles you might experience using cheap auto batteries.

FUEL CELLS

Fuel cells are not new devices, as one might think. An experimenter named Davy built one in 1801, and by 1839, cells which use gaseous fuels were being tested. Today it is possible to construct a fuel cell which uses gaseous hydrogen and oxygen to generate electrical energy, and do so at conversion efficiencies greater than possible with any other system.

Basically, a fuel cell is a form of battery in that electricity is generated by a chemical reaction within the device. Dry cells as used in ordinary flashlights and transistor radios are examples of a "primary battery." As power is consumed a primary battery wears out as the chemicals are used up. Automotive storage batteries are called "secondary batteries", and the chemicals in these devices can be regenerated by charging. These devices are intermittent in use, as they must be periodically recharged. Fuel cells, however, are continuous duty batteries because they consume externally supplied chemicals. They're continuous, that is, as long as the supply of fuel lasts. Their advantage lies in their high efficiency.

The windmill converts wind energy into electrical energy

which must be stored. This electricity can be used directly to convert water into gaseous oxygen and hydrogen. These gases can be stored (separately, mind you) and eventually brought together in a fuel cell to be reconverted to electrical energy, and water. This process is pollution free, but, for now, not entirely practical due to the price of the fuel cell. Ultimately, fuel cells will be made practical as they are further developed.

FLYWHEELS

Flywheels store energy by means of high-speed rotation of a heavy disc, or wheel. It's a simple matter to design a system which uses windmill supplied electrical energy to spin-up a flywheel. This flywheel energy will be converted back to electricity as needed because the same motor that spins the flywheel can act as a generator.

By using newly created structural materials like the synthetic and organic fibers used in aerospace applications, it is possible to build a super-flywheel -one which spins incredibly fast, that can store, say, 30 kilowatt-hours of energy. A flywheel of this size would weigh only a couple of hundred pounds. Now, that's equivalent to thirty batteries of the one kilowatt-hour size used in automobiles, and you know what each of those weighs. Also, a super-flywheel can be recharged virtually indefinitely, does not require chemicals, and can be designed for a shelf life -which is the time it would take to spin-down just because of bearing friction, of several weeks.

PUMPED WATER

Storage batteries and pumped water are perhaps the most likely to be used methods of energy storage by experimenters. In the case of pumped water all you need to do is, say, build two water storage ponds, one much higher up a hill than the other.

Earlier discussion showed how to calculate power required to pump water at a certain flow rate up a desired height. The same chart shows how much power you can get back by allowing water from the upper pond to flow back to the lower pond.

To store really large amounts of energy your ponds will look more like lakes, and there will be an altitude difference of several hundred feet. Rather large pipes in the return line will be needed to get as large a flow rate as possible, but the windmill can fill the upper pond slowly, if necessary.

INVERTERS

If DC (direct current) as produced by a DC generator or alternator is to be used by conventional household devices rated at 110 volts AC (alternating current) DC must be converted to AC and the voltage (usually 12 or 24) must be stepped up to the required value. This is done by an electronic device called an inverter.

Radios installed in older automobiles used a vibrator (mechanical inverter) which made a humming sound while a vibrating reed relay inside a little silver can oscillated back-and-forth to interrupt DC current and cause AC. Modern inverters use high-powered transistors as electronic oscillators to make this change.

Inverters are usually quite efficient, as man-made devices go - on the order of 80 to 90 percent of the electric energy they take in will come back out. Their highest efficiency is obtained when inverters are operating near the maximum power capability. See Figure 28.

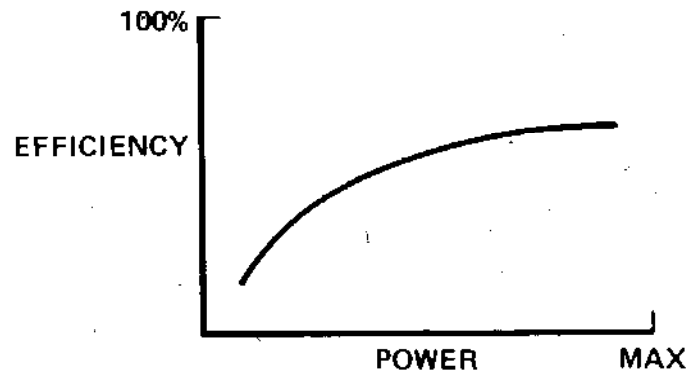

TYPICAL INVERTER EFFICIENCY

Figure 28

BIBLIOGRAPHY

Excellent bibliographies on various alternative energy subjects are already available. The following items are listed to add to, rather than duplicate the work of others.

PLANS

Savoïious Rotor

Hackleman, Michael A., WIND & WINDSPINNERS, available for \$7.50 from Earthmind, 26510 Josel Drive Saugus, Calif. 91350.

Horizontal Axis

Helion - 12/16 Plans - optional size, construction methods, and alternators. Aluminum blades. Complete plans and instructions for \$10 from Helion Box 4301, Sylmar, Calif. 91342.

Hybrid

Write to Helion - address above.

STRUCTURES

Bruhn, E. F., ANALYSIS AND DESIGN OF FLIGHT VEHICLE STRUCTURES, available from Tri-State Offset Company, 817 Main Street, Cincinnati, Ohio, 45202. Several completely untrained experimenters have used this book to design some rather sophisticated home-built aircraft. A great source of data.

AIRFOILS

Rice, M. S., HANDBOOK OF AIRFOIL SECTIONS FOR LIGHT AIRCRAFT available from Aviation Publications, Box 123, Milwaukee, Wisconsin, 53201.

SOARING MAGAZINE, January 1964, and November 1973. Data on high performance Wortmann airfoils. Available from Soaring Society of America, Box 66071, Los Angeles, Calif. 90066.

Abbott and Von Doenhoff, THEORY OF WING SECTIONS, Dover Publications, 180 Varick Street, New York, 14, N.Y. Data on all of the major NACA Airfoils.

GENERAL

WIND ENERGY BIBLIOGRAPHY, available from Windworks, Box 329, Route 3, Mukwonago, Wisc. 53149, for \$3.

CATALOG OF AIRCRAFT CONSTRUCTION SUPPLIES, available for 25¢ from All Aircraft Parts, 16673 Roscoe Blvd., Van Nuys, Calif.

Photo Credits

- George Helmholtz pg. 24
3 Blade Horizontal Axis Windmill
- C: Hogan-Esch pg. 4 & pg. 67
Dutch Windmills
- Sandia Laboratories pg. 63
Eggbeater Hybrid
- W. C. Strumpell pg. 23
Water Pump Windmill
- C. L. Swett pg. 62
Augmented Wind Turbine

Appendix A

WINDMILL DATA

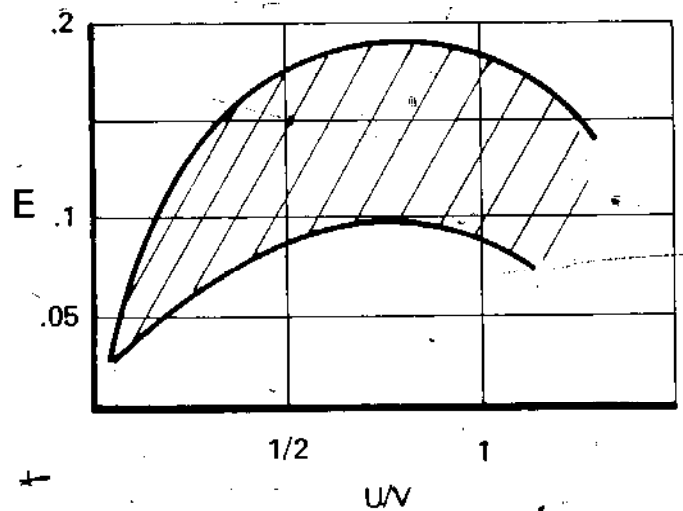
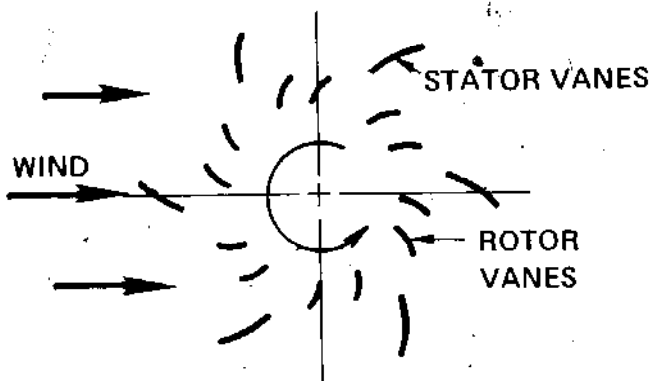
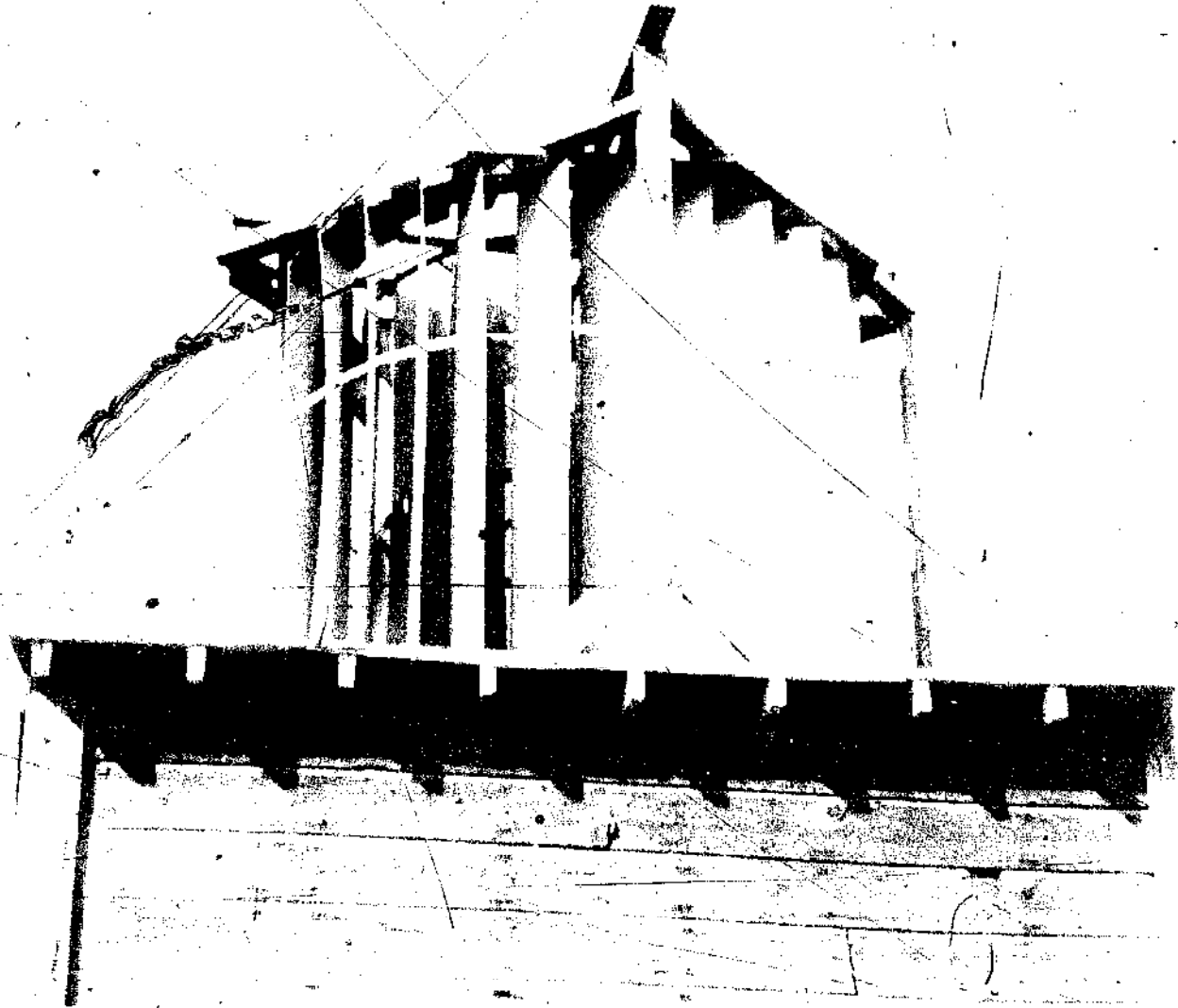

AUGMENTED TURBINE WINDMILL

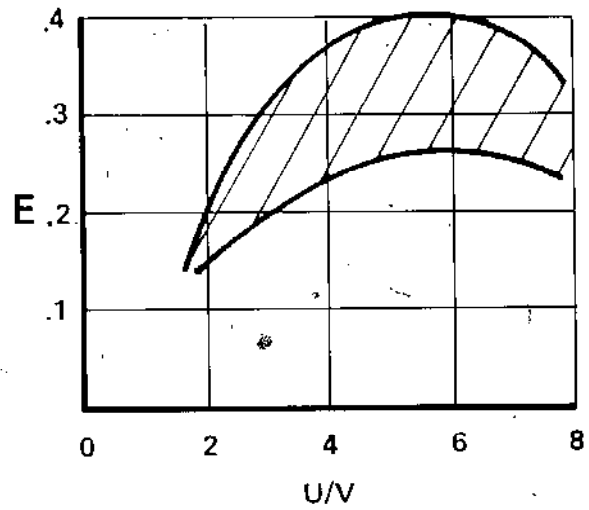
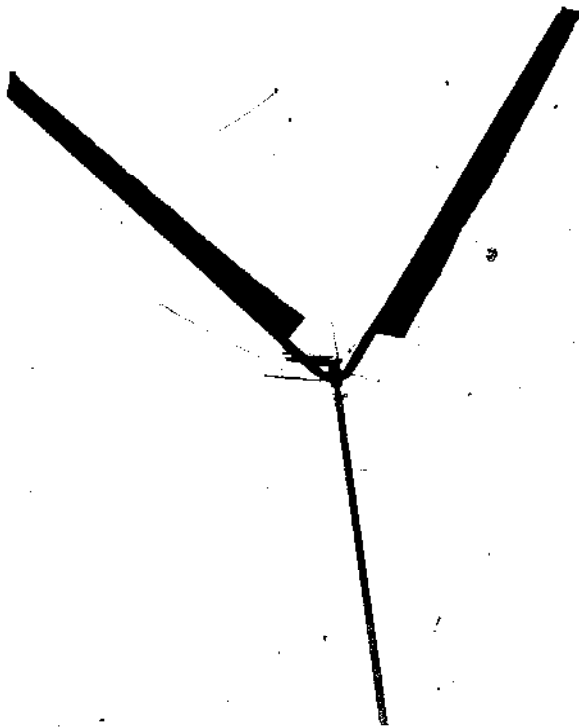
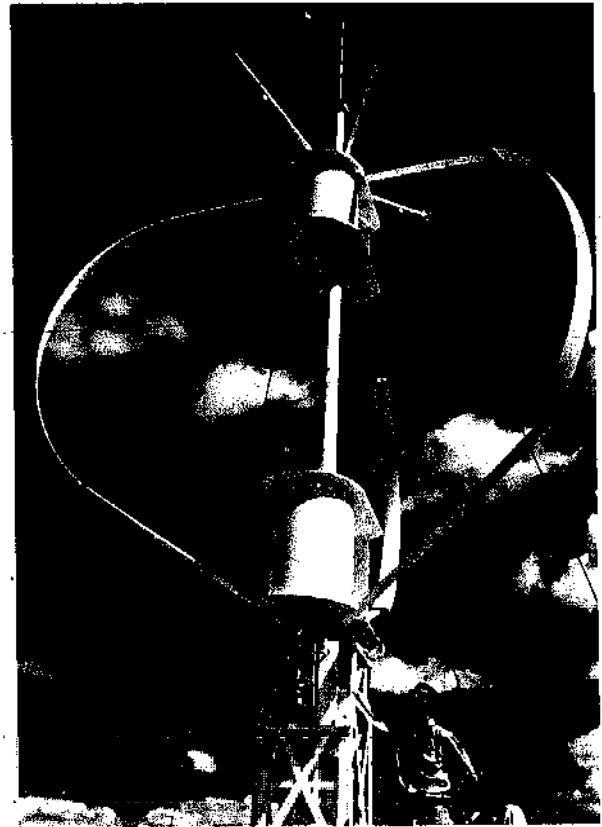

HYBRIDS

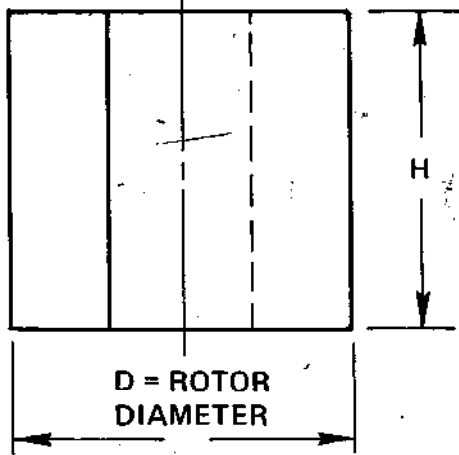
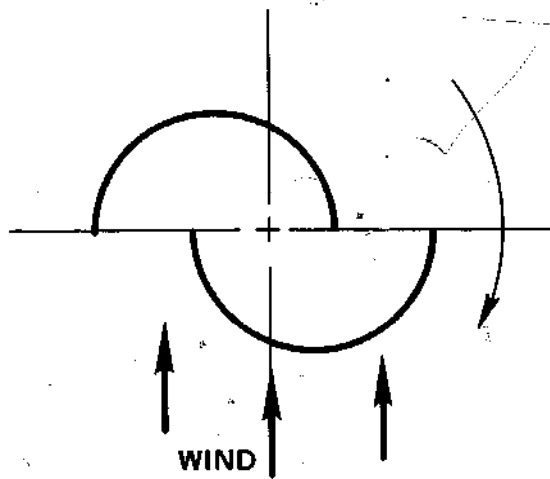

SINGLE TIER SAVONIOUS

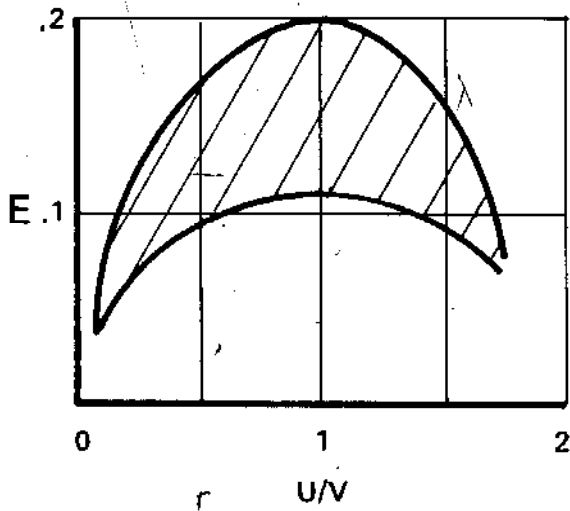

SAVONIOUS ROTOR

NUMBER OF VANES

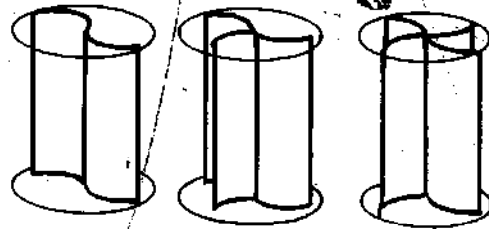

ASPECT RATIO

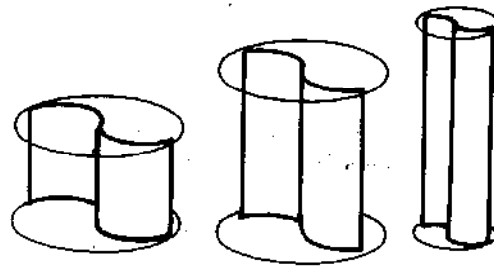

VANE FORM

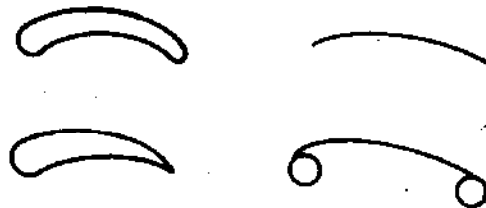

CONFIGURATIONS

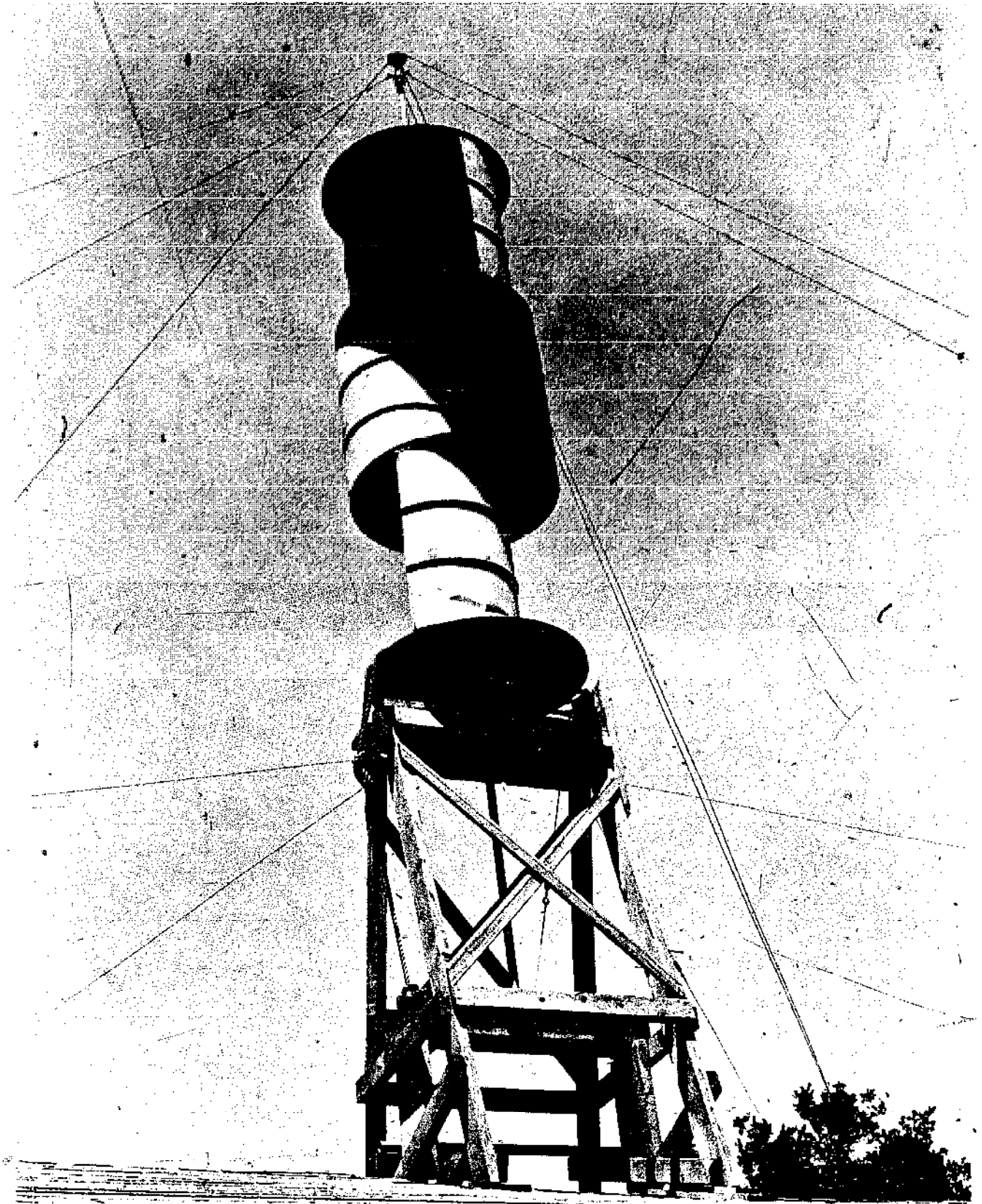



MULTI-BLADE WATER PUMP WINDMILL

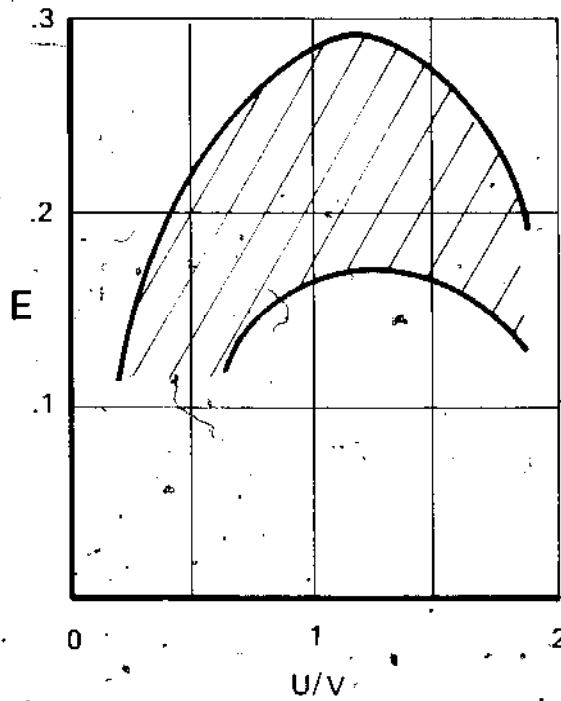



DUTCH WINDMILL

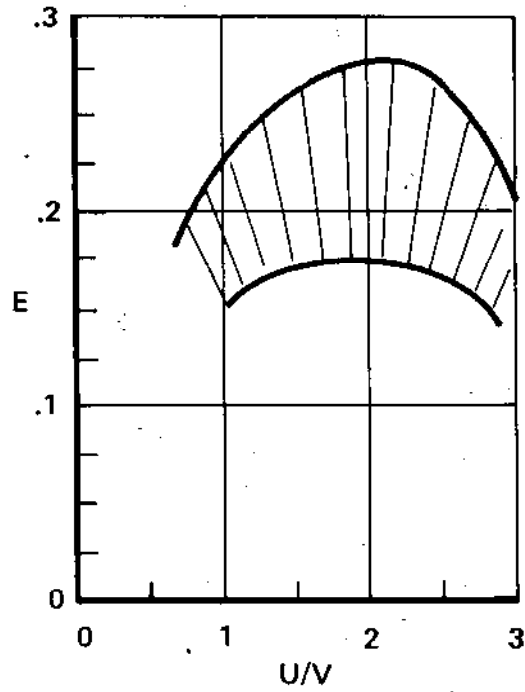

HIGH-SPEED
HORIZONTAL AXIS WINDMILLS

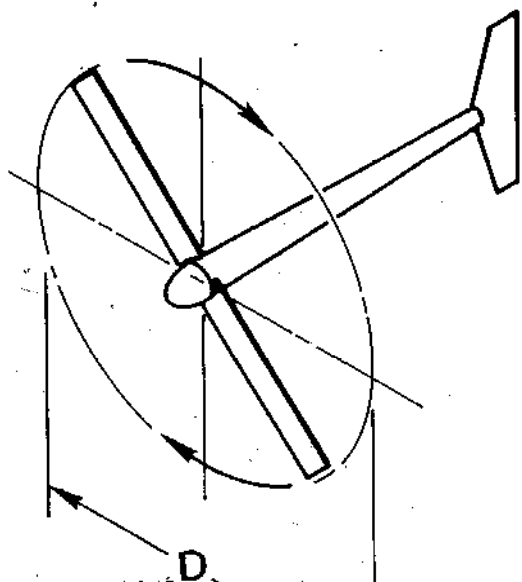

TWO BLADE

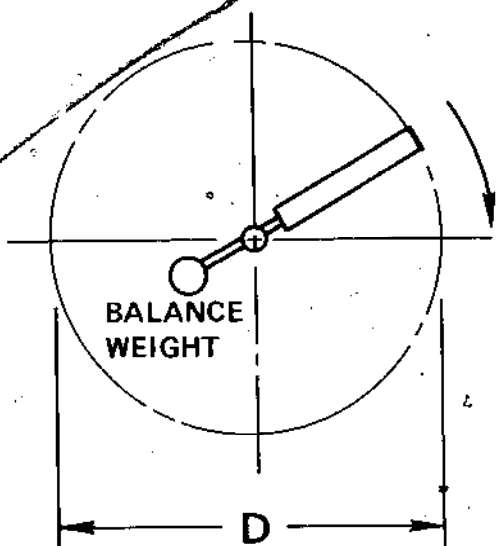

SINGLE BLADE

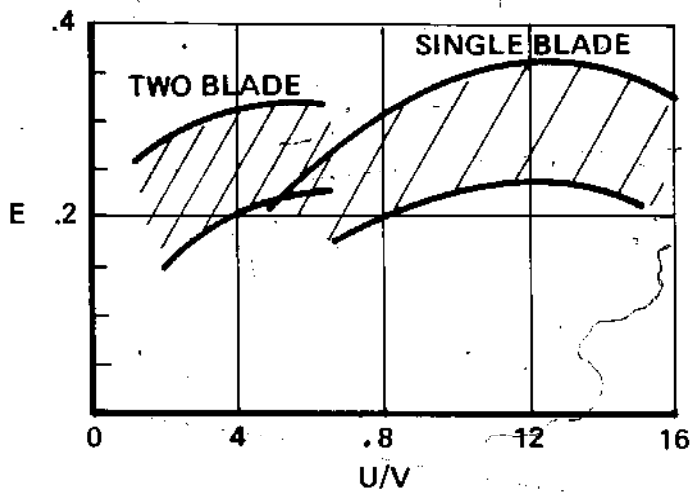

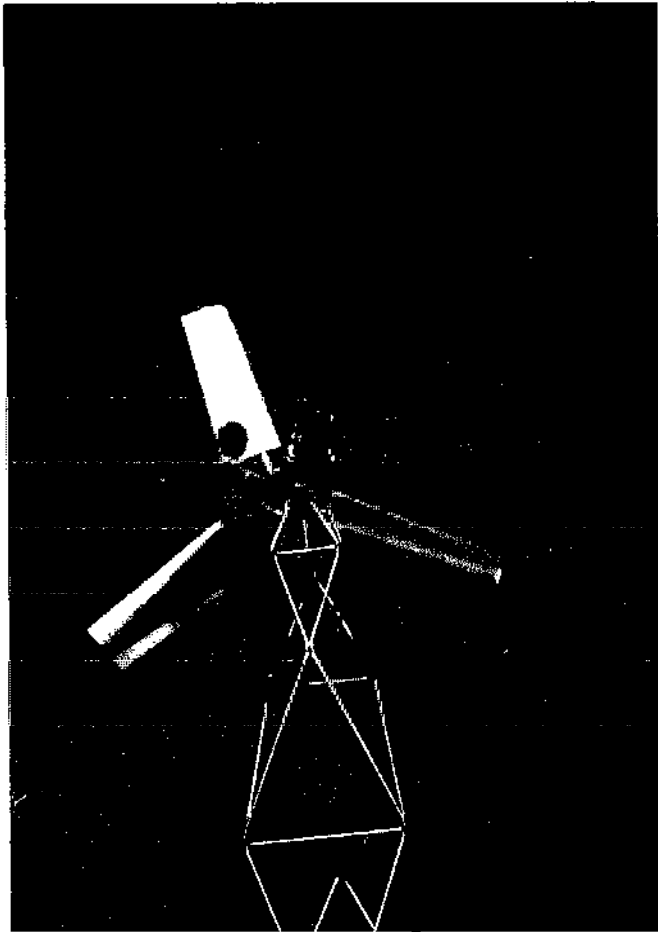

HIGH-SPEED
HORIZONTAL AXIS WINDMILLS

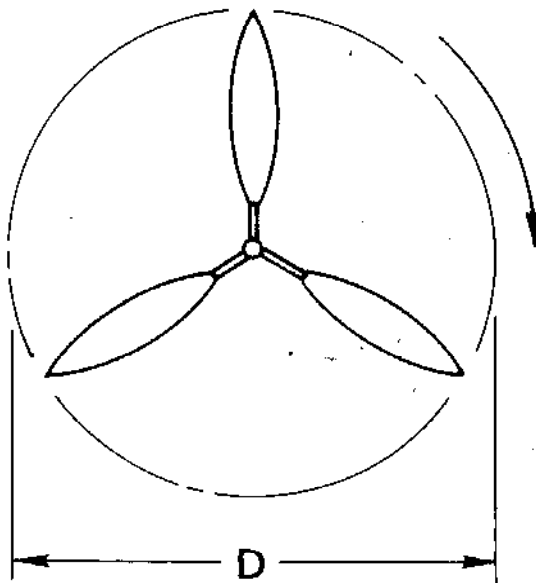

THREE BLADE

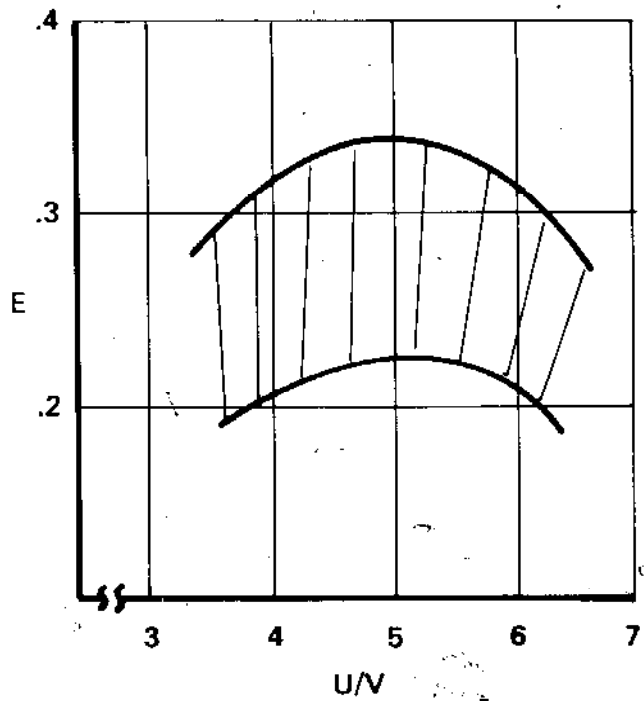

Appendix B AIRFOIL DATA

Following is a discussion of the method by which you can lay out an exact airfoil shape according to some numbers which are presented in this section of the book. A graph is presented which shows the lift coefficient performance for each of the airfoils listed. This graph will help you in Blade Angle computations. Other airfoils are available, some better than those listed here, many less suitable. Check the bibliography in this book for sources of further airfoil information.

HOW TO LAY OUT AN AIRFOIL

The numbers presented for each type of airfoil are percentages of the airfoil's chord length. When you have determined chord lengths, you can calculate dimensions from which to develop the exact airfoil shape much as you would plot a graph.

EXAMPLE

A few of these numbers for the Clark Y airfoil are:

Station	Upper	Lower
0	3.50	3.50
1.25	5.45	1.93
2.5	6.50	1.47
5.0	7.90	.93

and so on

For simplicity let's assume a chord length of 10 inches. Then you multiply each number in the box by the chord length. Remember that these are percentages before multiplying by chord length, -that is, 3.50 percent is really 0.035, and 1.25 percent is really 0.0125. Move the decimal point two places to the left. You may run into some source of airfoil numbers listed as the real multiplier number rather than as a percentage. In this case, use the numbers as they are. Then, multiply:

Station	Upper	Lower
0 x 10 = 0	0.35 x 10 = .35	0.35 x 10 = .35
.0125 x 10 = .125	.0545 x 10 = .545	-----ETC

Now you simply plot the airfoil on a large sheet of graph paper. Start on a straight horizontal line. Always measure from Station = 0 to the right to each next station point, then measure up or down to the upper or lower points. Measure up from this line by the upper value. Make a dot at this point. Then, at the same station, measure from the horizontal line to the lower value. If the lower value has a minus (-) sign, measure below the line. If not, the lower value is measured above the line. Some sources of airfoil information will have different station values for the upper point than for the lower value. For these airfoils, you will have to compute the different additional station values. Keep them separate.

By making all the dots for the upper and lower values, you will generate a series of dot targets which, when connected with a curved line, will form the airfoil shape.

The "LR" value is the leading edge radius. Again, it's a percentage of the chord. For the Clark Y, LR = 1.5%, or 0.015. For a 10 inch chord, leading edge radius = $10 \times .015 = .15$ inches. Use this value to shape the curve at the leading edge with a compass or draftsman's circle guide. Some airfoils will not show the leading edge radius value. This is really a reference number. You can draw the curve without it.

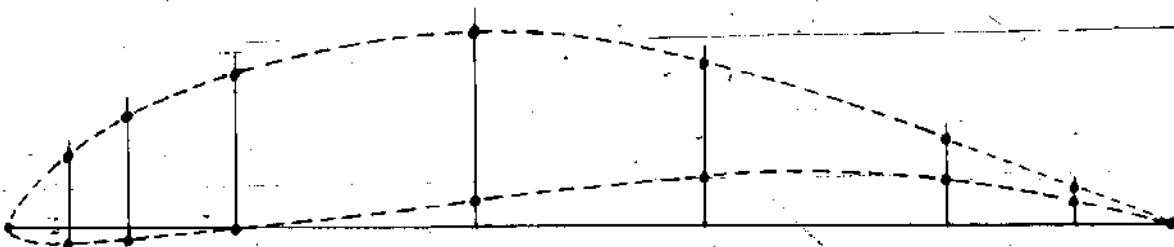

EXAMPLE FX 72-MS-150B

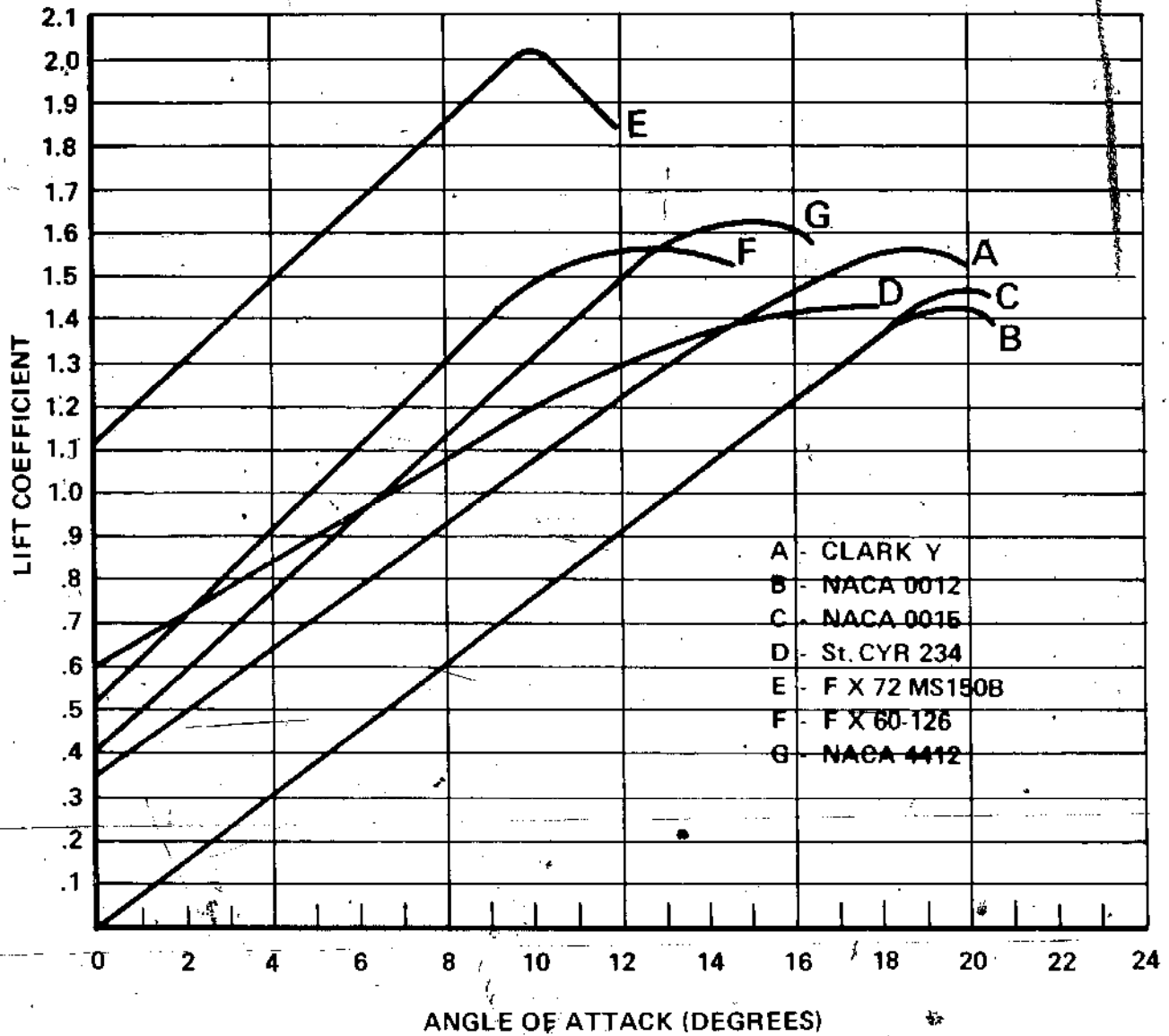

AIRFOIL LIFT AND ANGLE OF ATTACK DATA

SELECTED AIRFOIL ORDINATES

STA	CLARK Y		St. CYR 234		NACA 0012		NACA 0015		NACA 4412		
	UPPER	LOWER	UPPER	LOWER	UPPER	LOWER	UPPER	LOWER	UPPER	LOWER	
0	3.5	3.5	6.42	6.42	0	0	0	0	0	0	
1.25	5.45	1.93	9.55	3.75	1.89	-1.89	2.37	-2.37	2.44	-1.43	
2.5	6.5	1.47	11.0	2.7	2.62	-2.62	3.27	-3.27	3.39	-1.95	
5.0	7.9	.93	12.7	1.4	3.56	-3.56	4.44	-4.44	4.73	-2.49	
7.5	8.85	.63	13.8	.85	4.2	-4.2	5.25	-5.25	5.76	-2.74	
10	9.6	.42	14.6	.5	4.68	-4.68	5.85	-5.85	6.59	-2.86	
20	11.36	.03	16.2	.2	5.74	-5.74	7.17	-7.17	8.8	-2.74	
30	11.7	0	16.55	.65	6.0	-6.0	7.5	-7.5	9.76	-2.26	
40	11.4	0	16.1	1.1	5.8	-5.8	7.25	-7.25	9.8	-1.8	
50	10.52	0	15.2	1.35	5.29	-5.29	6.62	-6.62	9.19	-1.4	
60	9.15	0	13.3	1.9	4.56	-4.56	5.7	-5.7	8.14	-1.0	
70	7.35	0	10.8	1.35	3.66	-3.66	4.58	-4.58	6.69	-.65	
80	5.22	0	7.75	1.05	2.62	-2.62	3.28	-3.28	4.89	-.39	
90	2.8	0	4.0	.5	1.45	-1.45	1.81	-1.81	2.71	-.22	
100	0	0	0	0	0	0	0	0	0	0	
LR = 1.5						LR = 1.58		LR = 2.48		LR = 1.58	

STA	FX 60-126		FX 72-MS-150B	
	UPPER	LOWER	UPPER	LOWER
0	0	0	0	0
1.7	2.77	-1.37	3.05	-1.23
2.65	3.44	-1.8	4.01	-1.24
5.16	4.81	-2.48	6.15	-1.14
6.69	5.46	-2.76	7.26	-1.03
10.33	6.59	-3.26	9.43	-.72
19.56	8.33	-3.75	13.32	.13
30.86	9.13	-3.39	16.05	1.16
40.24	9.04	-2.55	16.86	2.09
50.0	8.43	-1.42	16.16	3.27
59.75	7.4	-.3	14.21	4.25
69.13	6.08	.55	11.55	4.64
80.43	4.05	1.07	7.5	4.07
91.57	1.78	.85	3.23	2.21
100	0	0	0	0

Appendix C HOW TO READ A GRAPH

Graphs are used to simplify calculations. I have presented many graphs in this manual so that computations which are normally difficult will be made easily. So that all users of this text have graph reading ability, this page is presented.

CONDITION 1 - You know VALUE A and you want to find VALUE B on Sample Graph 1.

EXAMPLE A

If VALUE A equals 8, start on the horizontal line at 8 and look (or draw a line) vertically up to the curve. Next, look (or draw a line) horizontally to the scale at the left. Notice that the answer VALUE B equals 4.

NOTE - You may have more than one curve which applies to your problem. You select the curve which applies, or add a curve which does.

EXAMPLE B

Look at Sample Graph 2. Suppose that VALUE C in your problem equals 15, which is half-way between the line for C=10, and C=20. Simply add a line roughly half-way between the two and proceed as above.

CONDITION 2 - Refer to Sample Graph 1. You know VALUE B, and need VALUE A.

EXAMPLE C

Start at VALUE B. (B=2.5 in this example). Look to the right to the curve, then down. Notice that the answer is VALUE A = 4.

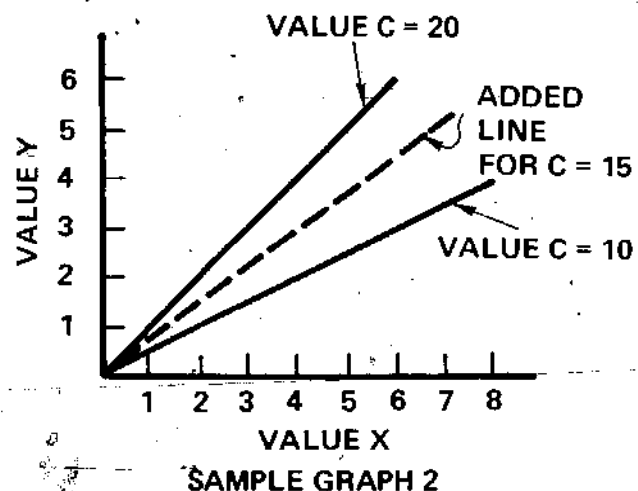
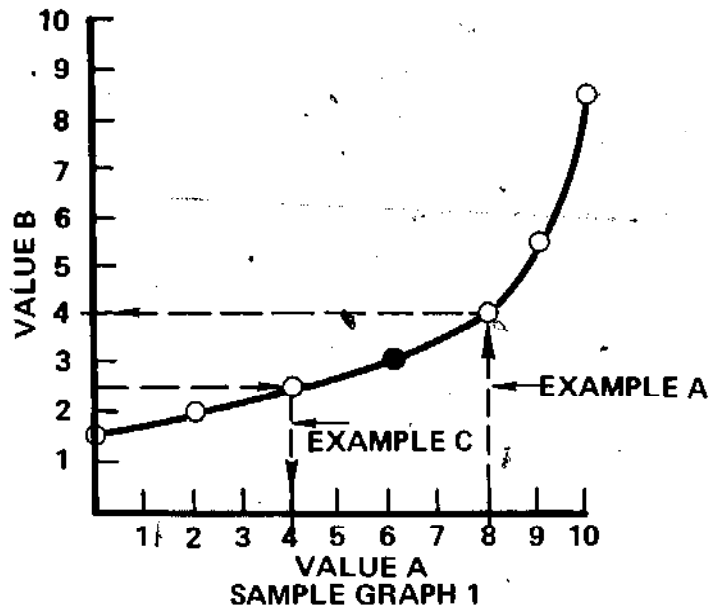

Appendix D

DETAILED WINDMILL PERFORMANCE

1 - Power = Force x Velocity

2 - Force = Pressure x Area

3 - Pressure = $\rho \times V^3 / 2$

where ρ = Mass density of air = 0.0024 slugs / foot³
at sea level

V = wind speed measured in feet per second

4 - Power = .0012 x V³ x A

where A = windmill frontal area measured in square feet

V = wind speed measured in feet per second

This is the theoretical power available in a wind of speed = V, acting across a windmill of frontal area = A. Power units here are foot-pounds per second.

5 - One Horsepower = 550 foot-pounds per second

6 = Horse Power = .0012 x V³ x A / 550 = 0.0000022 x V³ x A

Again, this is theoretical horsepower.

7 - The mathematical horsepower which a windmill can extract from the above value is 59.3% of the total. However, no windmill is perfect, and the actual maximum horsepower available from a windmill will be more like 10% to 40% of the total. For calculations, E will be efficiency factor.

8 - Actual Horsepower available from a wind = 0.0000022 x (k V)³
x A x E

where V = wind speed

k = a constant to adjust V

if V is measured in miles per hour, K = 1.47

if V is measured in feet per second, K = 1.0

A - frontal area of the windmill measured in square feet

E = the efficiency factor

9 - For calculation of electrical power: One horsepower = 746 watts

10 - Actual watts available from a wind = 0.0016 x (k V)³ x A x E

Appendix E

STRENGTH OF CONSTRUCTION MATERIALS

TUBE TENSILE STRENGTH

To compute tube tensile strength, measured in pounds of force, multiply tension area from Graph A below times the tensile strength factor for the metal alloy of the tube. See next page for tensile strength factors.

EXAMPLE

A 2-inch diameter by .065 inch wall thickness tube of Aluminum alloy 2024 T-4 is selected. Calculate the tensile strength. From Graph A, note that tension area equals .39. Tensile strength factor for this alloy is 60,000. Then Tensile Strength = $.39 \times 60,000 = 23,400$ pounds.

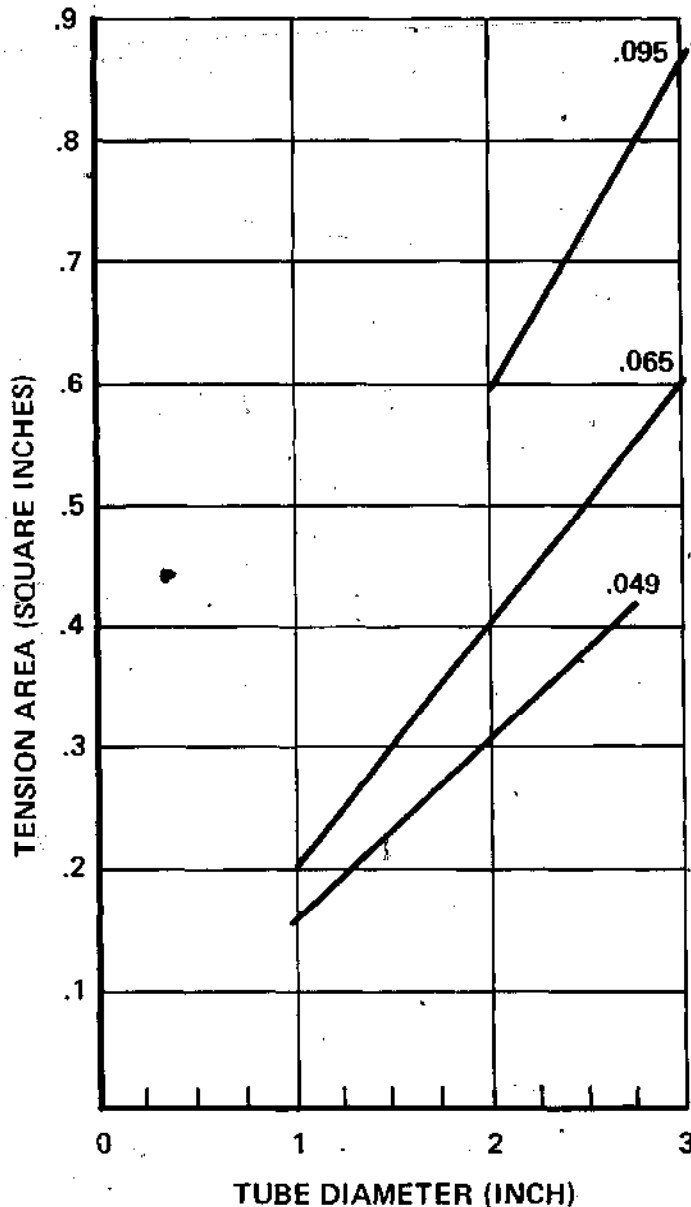

GRAPH A TENSION AREA FOR TUBE DIAMETERS AND THREE WALL THICKNESS VALUES

TUBE BENDING STRENGTH

To compute approximate tube bending strength, measured in inch-pounds, multiply K-value from Graph B below times the tensile strength factor.

EXAMPLE

A 2-inch diameter by .065 inch wall thickness tube of Aluminum alloy 2024 T-4 is selected. Calculate the bending strength. From Graph B, note that $K = 0.19$. Tensile strength factor for this alloy equals 60,000. Then Bending Strength = $0.19 \times 60,000 = 11,400$ inch-pounds.

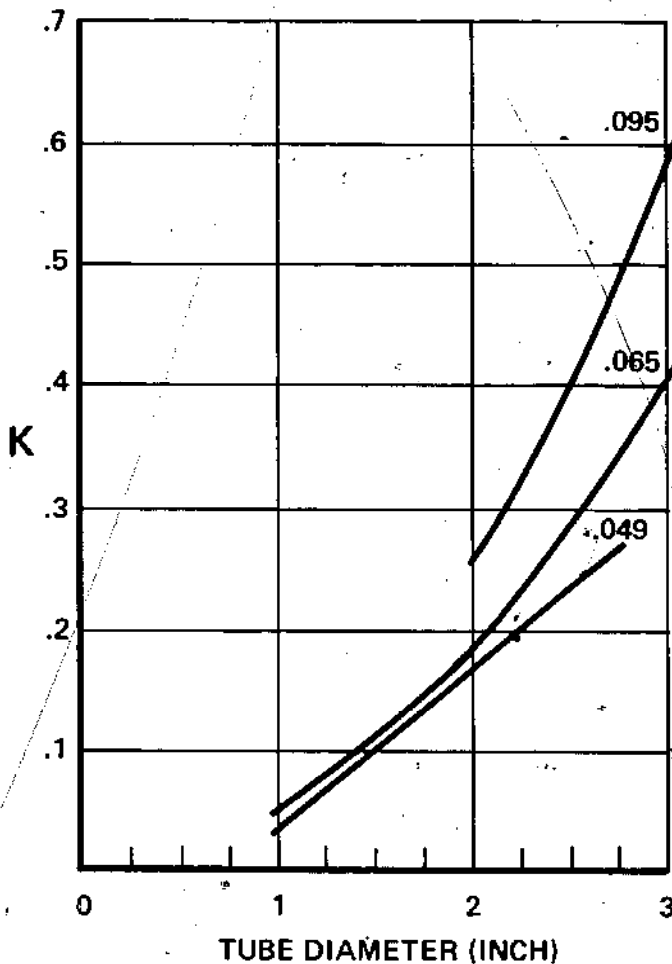

TENSILE STRENGTH FACTORS

Alloy	Tensile Strength Factor
Aluminum	
2024 T-4	60,000
6061 T-6	42,000
7075 T-6	75,000
Steel	
4130	
4130	90,000

GRAPH B K VALUE FOR TUBE DIAMETERS AND THREE WALL THICKNESS VALUES

TENSILE STRENGTH OF WOOD BLADES

Wood blades - as discussed earlier in this manual - are laminated and carved from quality materials like aircraft grade spruce. The Tensile Strength Factor for wood varies between 7000 to about 12,000 pounds per square inch. This value depends on the type of wood used, and the moisture content. Wood strength increases rapidly as the material dries out. For average wood used in the 10% to 15% moisture content range, a safe check of blade strength can be made with a tensile strength factor of 8,000. You need to know the tensile area of the blade. Then multiply this area times the strength factor to compute blade tensile strength.

EXAMPLE

The blade sketched has a tensile area for the structural wood forward portion (you can disregard any strength value in the balsa or foam trailing edge in this example) of approximately 12 square inches. Blade strength = $12 \times 8,000 = 96,000$ pounds. This is the maximum centrifugal tension load this blade can withstand.

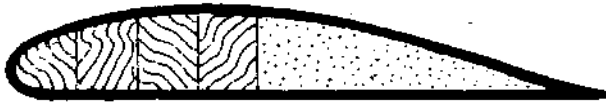

CABLE STRENGTH

Cables are used for tower guy wires, windmill bracing, and so on. Data presented is for 7 x 19 flexible aircraft stranded cable - available in surplus outlets, or the source listed in the Bibliography of this book.

CABLE DIAMETER (inches)	BREAKING TENSILE STRENGTH (pounds)
1/16	400
3/32	750
1/8	2,000
3/16	4,200
1/4	7,000

BOLT STRENGTH

Data presented are for aircraft quality (AN) bolts.

BOLT DIAMETER (inches)	SINGLE SHEAR STRENGTH (pounds)	TENSILE STRENGTH (pounds)
3/16	2,100	2,200
1/4	3,600	4,000
5/16	5,700	6,500
3/8	8,200	10,100
7/16	11,200	13,600
1/2	14,700	18,500

EXAMPLE 1

Two strips of steel are to be bolted together. The maximum tensile load in the strips is 8,000 pounds. The bolt will take this load in single shear. The minimum size bolt for this load is one 3/8 inch aircraft quality bolt, or two 5/16 inch bolts. Hardware store bolts will have to be larger in diameter.

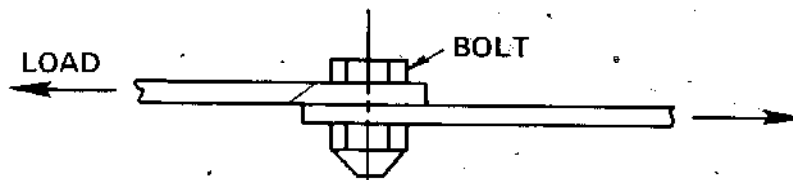

EXAMPLE 2

A wooden blade is to be bolted to a steel hub. The centrifugal force is equal to 20,000 pounds. The bolts are loaded in shear as illustrated below.

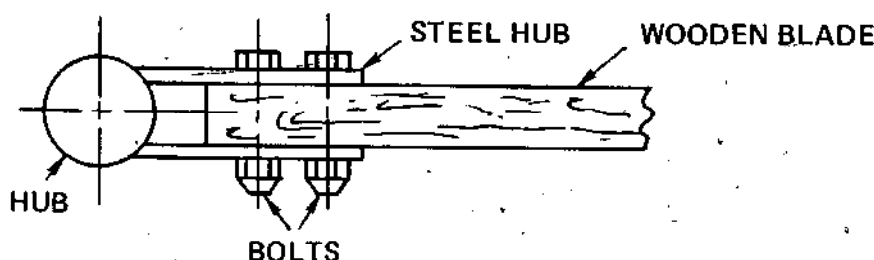

Notice in the sketch that the blade load ends up in two hub parts, which means that half of the load goes into each side of the blade. Thus 10,000 pounds is loaded at two different places along the attachment bolt - called double shear. Two 5/16 inch bolts could handle this load. In the case of wood blade attachment, lots of smaller bolts are recommended.

HELION

Box 4301 Sylmar, California 91342

(213) 367-8291

PUBLICATIONS LIST

February, 1975

The following lists the currently available publications from Helion. These documents deal with the field of wind energy. Publications, and products in other alternative fields are currently in the works.

SIMPLIFIED WIND POWER SYSTEMS FOR EXPERIMENTERS. Written for non-engineering trained people, this very popular book makes available the design process to anybody who can do simple arithmetic problems. 80 pages, with lots of graphs and example calculations, and photos showing various windmills, and construction details. Price - \$6, for the new second edition.

16 Windmill Plans. These plans offer highly detailed drawings, with written instructions for construction of this all aluminum blade 2-to-5 kilowatt windmill. You get drawings for both the 12 foot, and 16 foot diameter blades, with several options for construction methods, and generators. A photo essay detailing construction methods is included, as well as the engineering information concerning the machine's design. No plans are offered for the tower, but discussion and photos show how the windmill is raised up the tower. Only a few critical welds are necessary, with a few machined parts, and we have made arrangements to supply kits for these, and other parts. Completed windmills will also be made available. Plans price - \$10. This price is \$9, if purchased with our wind power book.



Wind Power Technical Memos - two are available:

- WTM 1 - Aerodynamic Layout of Windwheel Blades. A technical method for "optimum" layout. Price - \$1.
- WTM 2 - Hybrid Windmill Notes. Summarizes everything we believe we know about these windmills at this time. Price - \$2.

.....
All prices postage paid at Book rate. California residents add tax. Please include payment with order.

The Helion 12/16, shown with 12 foot blades with cowling removed.

