

***WindStuffNow.com***

[Click here to enter](#)



219451

- [Products](#)
- [Formulas](#)
- [Links](#)
- [Projects](#)
- [Blade design](#)
- [Basic Wind System](#)
- [3 Phase Basics](#)

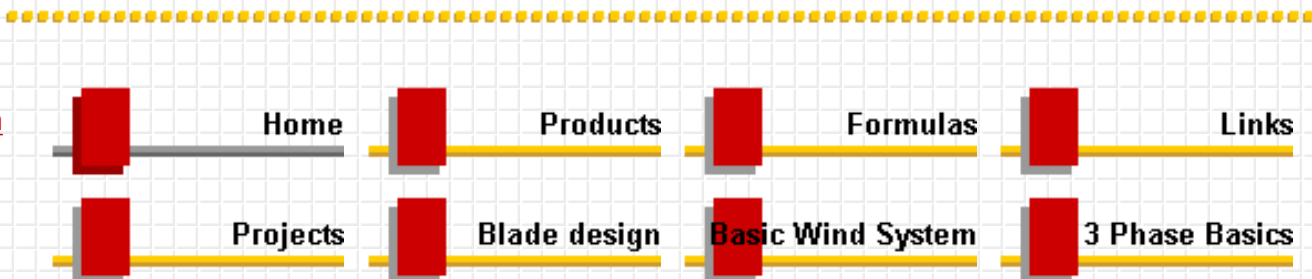

## *Dual Rotor Kit*

Available for a limited time



The dual rotor kit is based on the [dual rotor](#) unit on the projects page

## Start a new project or stock up for the next !!!



=> ***Special on the large neodymium segment magnets*** <=

=> ***\$5.50 each and flat rate shipping on any quantity*** <=

great rates to other places also! inquire about shipping costs to anywhere !!

Thanks for dropping by and Welcome!!!

As a dedicated "do it yourselfer" I put this site up for all those who share similar DIYS skills and convictions.

I hope what I have here helps you in your endeavors in some way, big or small.

This site is maintained using windpower only. My entire office is powered by the wind. Email me at [elenz@windstuffnow.com](mailto:elenz@windstuffnow.com) But... you must include something specific to the site in the subject line. Any email that has a blank subject line will be deleted and therefore not answered.

### ***A semi-new Vawt... the "Lenz turbine"***

### **New addition ...**

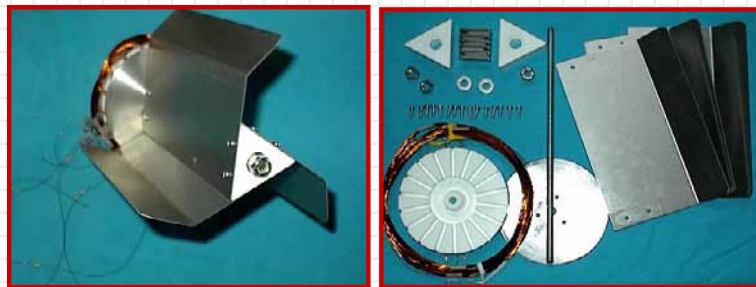

An educational 3 phase turbine kit. Comes with everything you need to create a 3phase wind turbine. Great for science projects, learning about 3phase PMG alternators, and alternative energy. The kit includes 6 very powerful neodymium magnets. Check it out!

### **Budget builders....**



More Neodymium magnets for those on a budget. They make nice alternators as shown in the section "[Alt from scratch](#)"



These are the new magnets I've been working with. They have proved to be quite impressive for building the axial flux type alternators and for building motors for electric vehicles. I have a few extras for those interested in them. Click on the picture to go to the builders corner page.



The original 6 ft turbine with a car alternator and chain drive. It was changed to the axial Flux type alternator and ended up being much more efficient and powerful. The chain drive was quite noisy because of the cogging in the modified alternator. It was in service for about 2 years and is now down for maintenance. Actually it will be refitted with a new alternator using the new magnets and the blades refurbished.



The downwind turbine, a very small but quite efficient little unit. This one was a bit more complicated to build but it features the star/delta controller ( check the link on downwind turbine for more detail)



One of the original alternator modifications. This one had a rewind stator and the modified rotor using Neo' magnets.

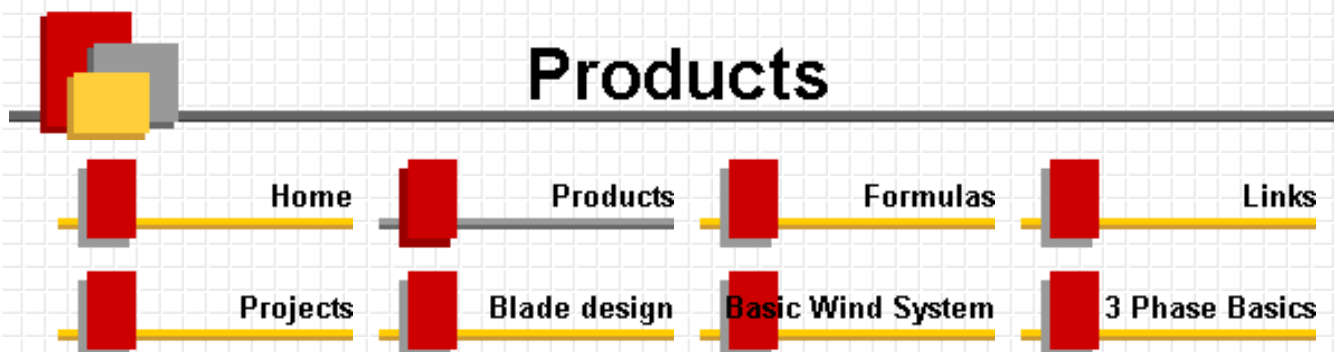

[Turbine kit](#)

[Builders Corner](#)

[3Phase turbine kit](#)



## Out of Stock - sorry

This is the book I talk about allot through this web site. I found it very enlightening, easy to understand, and very well written. This book explains very clearly: what is involved in deciding whether a wind system is for you: how to design such a system: how to design and build your own wind generator from scrap and recycled parts. If your serious about getting involved with wind power this is one book you can't live without! The book is **\$18.95 and this includes shipping! ( in the USA or Canada - email for other countries )**. Send an email to get a copy today! Or simply click on the "Buy Now" button to purchase through Pay Pal service.



These are no longer available. The page remains for an explanation of how it works for those wanting to build one themselves.

---

### Builders Corner - parts and pieces



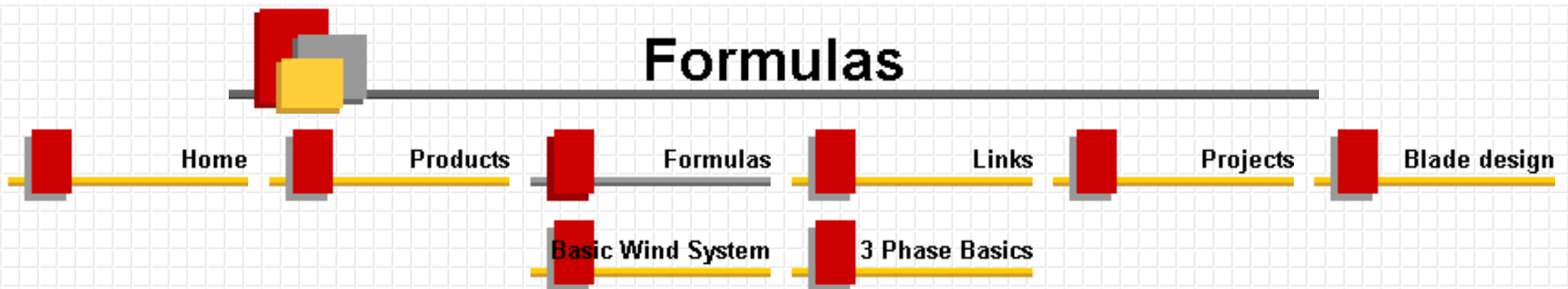

[Generator](#)

[Wind](#)

[Misc](#)

[Blade design help](#)

Bubble bubble toil and trouble.....Oh! ... Hi there....

This is where I hide all my formula's for figuring out this stuff.

Click on the link to the left for the area you would like to know more about.

Actually I was spending so much time with the calculator I decided to write a program that would figure this out much quicker. Below is a screen shot of the program. It will basically design and match the blades to any generator/alternator you have. After you input all the particulars ( Inputs are in bold print ) It will design the blade shape and twist, width and angles to cut the board, Give you an estimated performance output and match the alternator to that performance. If your interested in the program send an email [elenz@windstuffnow.com](mailto:elenz@windstuffnow.com) **Note: you must include a message in the subject line relating to this site or the email will simply be deleted and therefore not answered.** I'm charging \$5.00 for it to help cover costs of keeping this web site alive. This program runs under Windows 95/98/Me that I know of. If you have Microsoft Visual Basic5(sp3) or higher installed you will only need the .exe file otherwise you will need the full Set up program. The file is approximately 1.5 Mb.

When using this program all the fields must have a number greater than 0. If you leave a space blank it will crash (divide by 0 error). I haven't put any error catchers in as yet but will on later versions. If you like the program and have ideas of other things that could be incorporated into it please let me know.

Simply click on the "Buy Now" button to purchase this through pay pal service. When I recieve the payment I will send you an email with the download site and password to unzip the files. Run the Set up program from there and your all set to go.

There is a new help file for the program which you can look over [here](#) or you can click on blade design help in the upper left corner. Have Fun!



Blade designer
\_ □ ×

**Rotor diameter (meters)**

**Tip Speed Ratio**

**Number of Blades**

**Angle of attack (deg)**

**Lift coefficient**

**Number of stations**



**Calculate**

**Clear chart**

**Print Form**

### Estimated Prop performance

	Watts	RPM
10 mph 4.4ms	60	224
12 mph 5.3ms	103	269
14 mph 6.2ms	164	314
16 mph 7.1ms	244	359
18 mph 8.0ms	348	404
20 mph 8.9ms	477	448
22 mph 10ms	635	493
24 mph 10.7ms	824	538
26 mph 11.6ms	1048	583
28 mph 12.5ms	1309	628

Station	Radius (in)	Bld ang (deg)	Chord (in)	Thickne (in)	Drop (in)
1	12	19	9.32	1.4	3.58
2	24	8	5.24	.79	1.07
3	36	4	3.58	.54	.49
4	48	2	2.71	.41	.28
5	60	1	2.17	.33	.18
6					
7					
8					
9					
10					

### Calculated Generator performance

Amps	Open V	Rpm	Ratio	Watts at Rec Ratio
4.05405	17.2324	666.202	2.97411	82.7530
6.95945	18.9756	733.595	2.72712	172.716
11.0810	21.4486	829.200	2.64076	262.680
16.4864	24.6918	954.583	2.65900	352.644
23.5135	28.9081	1117.58	2.76629	442.608
32.2297	34.1378	1319.76	2.94589	530.572
42.9054	40.5432	1567.39	3.17929	620.536
55.6756	48.2054	1863.61	3.46396	710.500
70.8108	57.2864	2214.68	3.79877	800.464
88.4459	67.8675	2623.74	4.17793	890.428

Recommended Ratio

**Open Voltage**

**Measured Rpm**

**Measured Ohms**

**Regulated Voltage**

**INPUT: wind velocity in m/s to calculate rotor thrust**

Rotor thrust in pounds

Rotor offset in inches

Tail Size in square feet

# Links

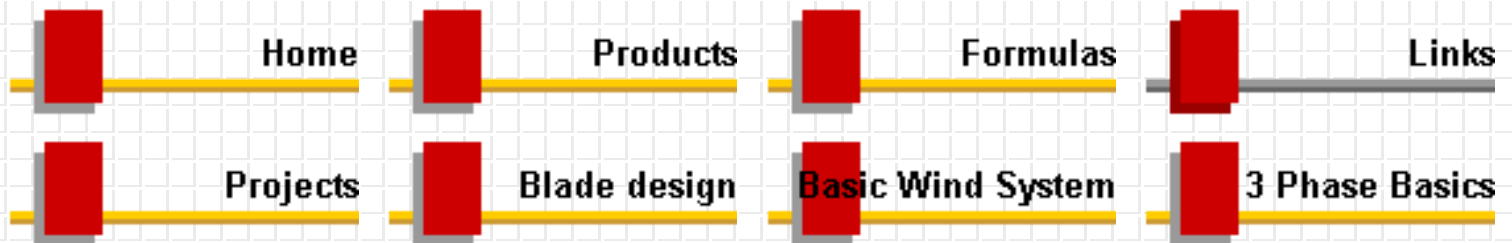

Here are a couple of great links to start with... There will be more added as time goes on.

[www.otherpower.com](http://www.otherpower.com) They sell magnets and lots of other goodies we like to play with. Also their site offers a world of information. They also have another site where they sell their magnets and other trinkets to play with at [www.wondermagnet.com](http://www.wondermagnet.com)

[www.homepower.com](http://www.homepower.com) Magazine dedicated to us DIYS'ers of home brewed power

[www.ScoraigWind.co.uk](http://www.ScoraigWind.co.uk) I learned a lot from Hugh Piggott, and would strongly recommend his books to anyone getting involved with wind power.

<http://webconx.green-trust.org> has a wealth of information on just about any kind of Renewable energy you can think of. Expect to spend some time on this site...

[www.utterpower.com](http://www.utterpower.com) . slow speed engines, generators, and more" ... Lots of cool stuff we like to play with...

[www.acs.comcen.com.au](http://www.acs.comcen.com.au) lots of DIY projects, information and links.  
[www.acs.comcen.com.au](http://www.acs.comcen.com.au) lots of DIY projects, information and links.  
[www.acs.comcen.com.au](http://www.acs.comcen.com.au) lots of DIY projects, information and links.

<http://www.ndsu.nodak.edu/ndsu/klemen> This site has information about small manufactured wind turbines as well as other information about wind power  
<http://www.ndsu.nodak.edu/ndsu/klemen> This site has information about small manufactured wind turbines as well as other information about wind power  
<http://www.ndsu.nodak.edu/ndsu/klemen> This site has information about small manufactured wind turbines as well as other information about wind power  
<http://www.ndsu.nodak.edu/ndsu/klemen> This site has information about small manufactured wind turbines as well as other information about wind power

<http://www.bioelectrifier.com> has a real slick "mini" wind generator along with solar and wind charge controllers as well as other unique gagets. Mike is a tinker'er just like us!

<http://www.dsgnspec.com> -Rob has some great stuff for us experimentors... lots of electronic gizmos we all gott'a have. This is where the star/delta switch I used in my downwind turbine project came from and it works flawlessly! **Also !!! If your looking for a small hand held tach, the non-contact type you gotta' check out the "Tach JR" Perfect little tach at the right price!!! Dont miss out!!!**

<http://www.learnonline.com>-Great place to learn about renewable energy for young and old. A new and interesting way of learning.<http://www.learnonline.com>-Great place to learn about renewable energy for young and old. A new and interesting way of learning.

<http://disposalmovie.tripod.com> -Off topic but a great movie to experience. Plus you can help support a young upcomming movie maker. A must see!

[www.dragonflypower.com](http://www.dragonflypower.com) - lots of good information on wind power as well as a nicely built windturbine using an auto alternator.

<http://www.ecs-solar.com> - The Solar Industry's Water Heater Bible  
" Hot Water Systems: Lessons Learned 1977 to Today " Solar Hot Water and Pool Heating Design / High Performance Low Maintenance Systems / Reality Checks Using Current Technology...a definitive how-to book for installing and maintaining high-performance and low-maintenance solar hot water systems -- written by one of the leaders in solar contracting today.

[www.yourgreendream.com](http://www.yourgreendream.com) - another nice site for the DIY wind / solar and more! check it out.

[www.thebackshed.com](http://www.thebackshed.com) - Great DIY site with lots of fun projects we all like to see and build - cool stuff!

If you have a site based on the "do it yourself" or "how to" category and would like to be added to this list please send me an [elenz\(nospam\)@windstuffnow.com](mailto:elenz(nospam)@windstuffnow.com) I would be happy to exchange links!

**NOTE:** There must be something in the subject line relating to this site or the email will be deleted and therefore not answered.

# Projects

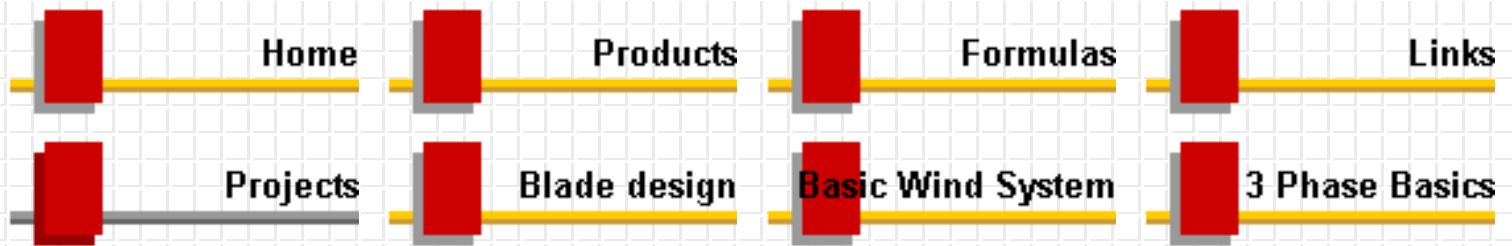

- [Stirling engine](#)
- [Gm Alt mod](#)
- [Wind turbine](#)
- [Alt from Scratch](#)
- [Down wind turbine](#)
- [Darrieus Type](#)
- [Stirling Generator](#)
- [Microwave wind generator](#)
- [Poured Stator](#)
- [One hour projects](#)
- [VAWT](#)
- [Dual rotor wind turbine](#)

## Projects from the past and present....

Click on the links to the left to check out some of the projects I'm either working on or are past projects.



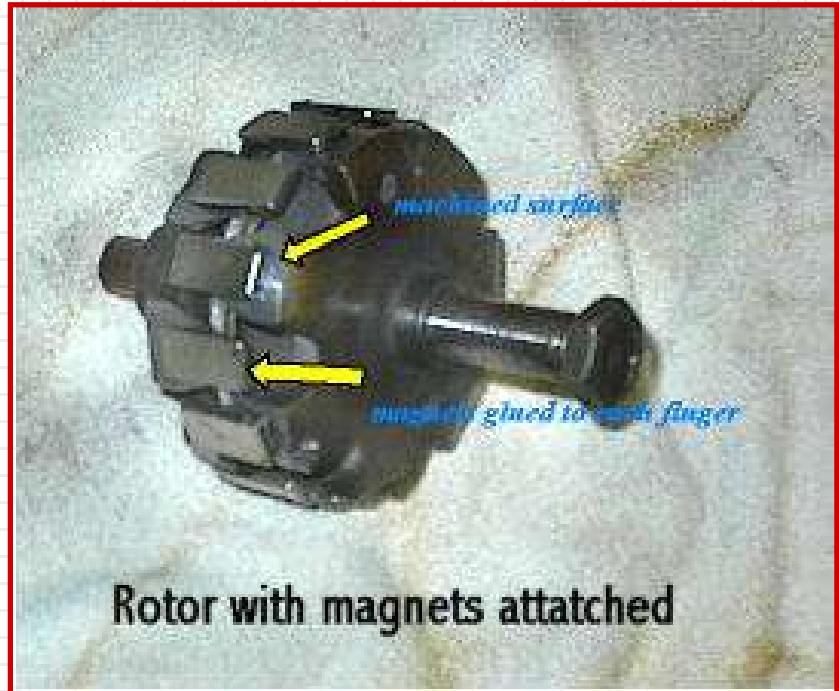









# Blade design

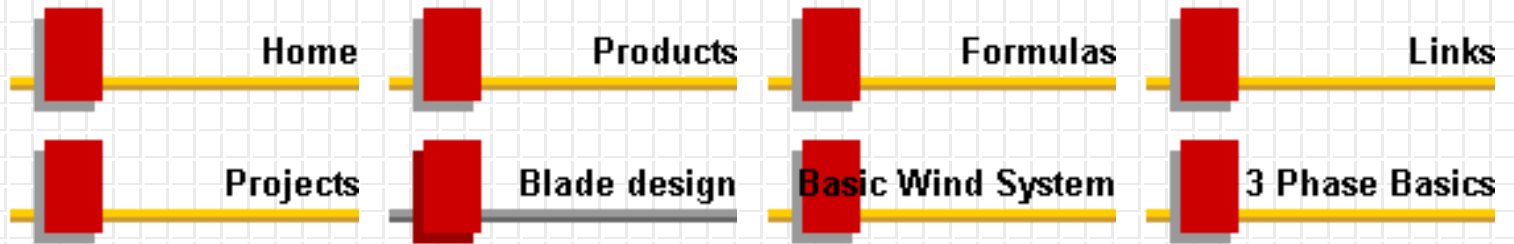

Here are some notes to aid in designing your blades....If you purchased the [Blade designer](#) program all the numbers will fall in place.

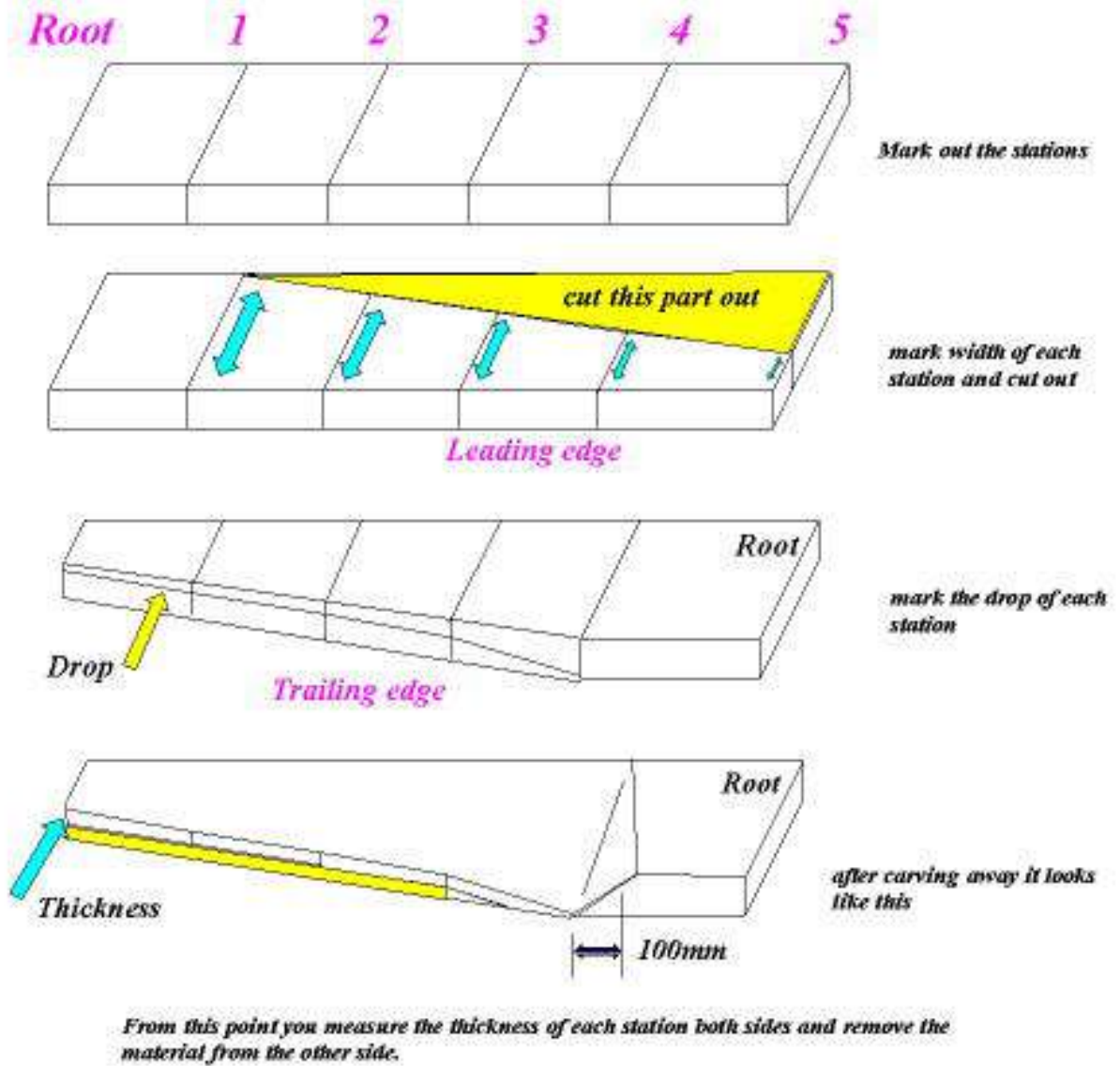

Step 1: Mark out the stations

Step 2: mark width of each station cut out all unnecessary wood

Step 3: mark the drop of each station and draw a line

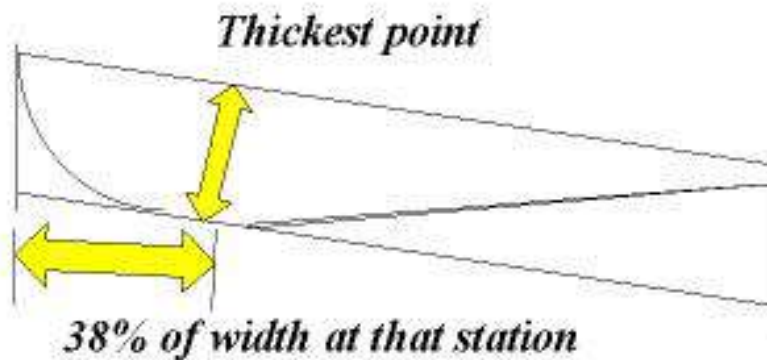
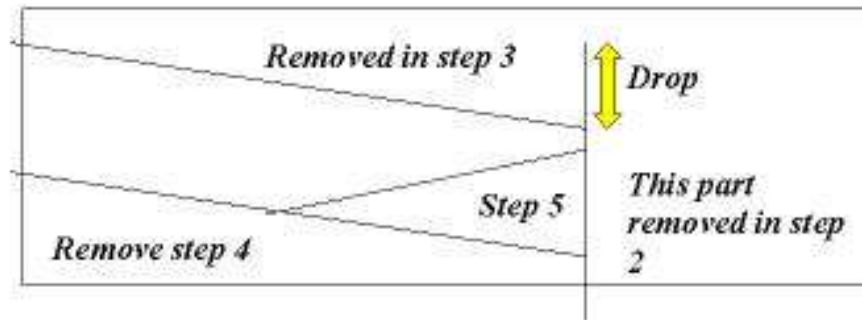

Step 4 mark the thickness at each station ( both sides) then remove the excess material

Step 5. Mark each station at 38% of station width, draw a connecting line and carve the material to shape the wing. Make sure you don't cut the line. This will be the thickest part of the blade.

If you don't want to go through all of that you can build a blade from station 4. Using the angle and width and make one straight blade from this. Once the blade is made you can glue angle blocks on the new blade at the angle it will be installed.

# Basic Wind System

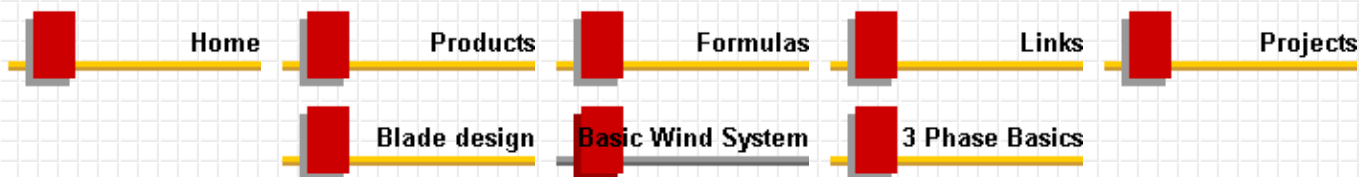

The diagram below shows the components for a basic wind system using a 3 phase alternator. The AC from the alternator is brought into the power room then converted to DC through a rectifier. The shunt regulator maintains the batteries. The DC is then converted to AC through an inverter.

Basic System using 3 phase alternator

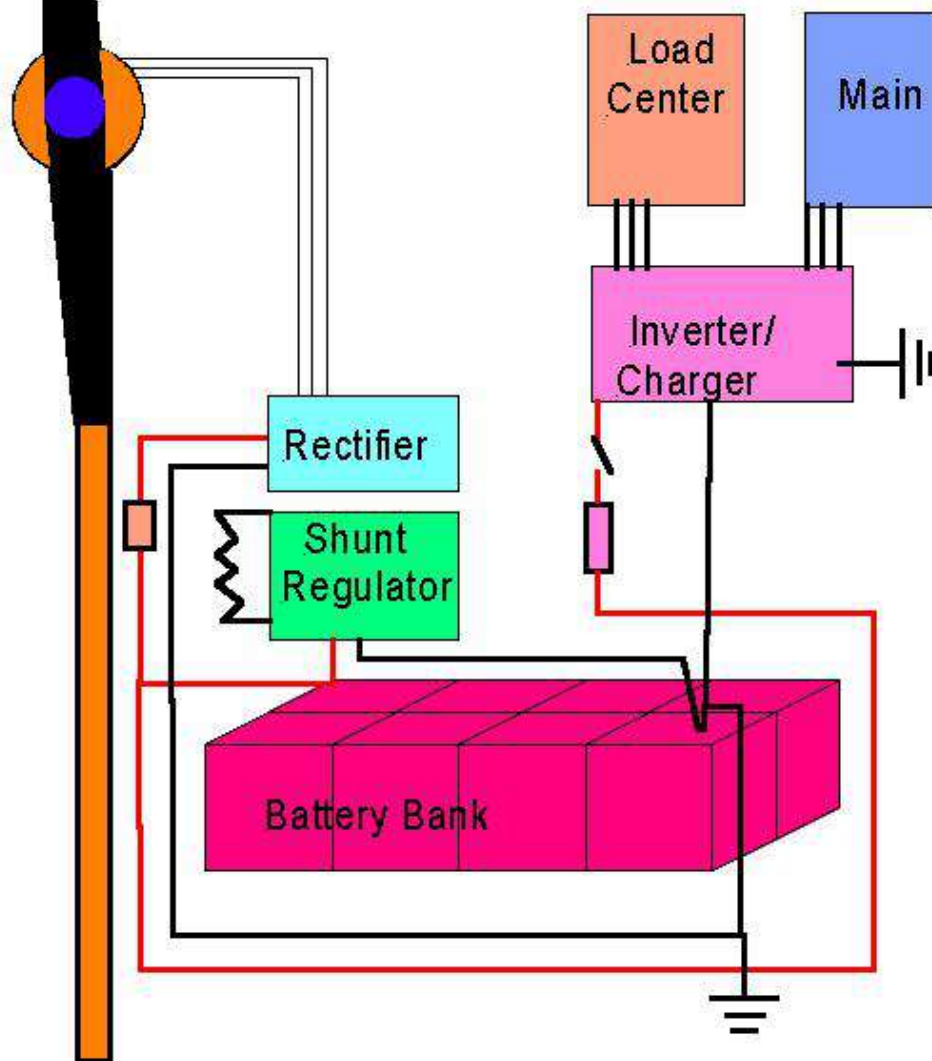

My control box ( shown below ) is a very inexpensive "homebrew" controller. It houses everything for an "all in one" type controller. I suppose you could say its a "Frankenstein" controller.... The box was made from an old Compaq Computer Power supply, the rectifier from a 60 amp GM alternator, regulator circuit from [www.homepower.com](http://www.homepower.com) , and the heaters are made from aircraft safety wire ( measured to 1 ohm each). You can note the circuits are put together on experiment boards because my soldering skills are much lacking when it comes to IC's. If it could be done with a Lincoln 220 or a Mig welder I'd have no problem....

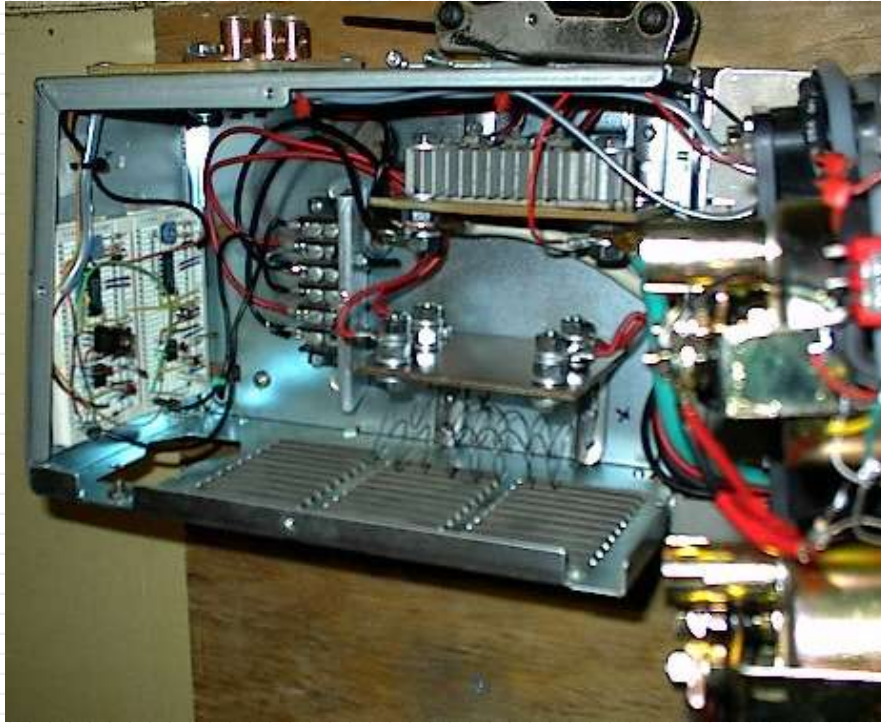

The face of the unit shows the fan, volt meter and amp meter. The fan is set to come on whenever the shunt units are operating and blows the air out the bottom of the unit to heat the room. Below shows the face of the control box. Very low tech.... Total cost = \$24.00



You can see the 3 AC lugs on the top of the unit and the DC lugs on the side. It has an on-off switch on the left with a green LED to tell you its on and 2 red LED's tells which shunt is operating. There are 2 shunts regulators in the unit to dissipate a total of 500 watts if needed.

Below shows my power room set up. I have 8 T-105 Trojans batteries, a Trace DR2412 to power my entire office and Day house. On line with the Trace is a complete computer system, Frig, TV, 2- 8foot fluorescense, 1- 4ft fluorescent, 1 CF for the bathroom, 1 40 watt shower light, 600 watt microwave, coffee maker and misc phone plugs. The power room used to be a Milking parlor and the main

office was the processing and storage of milk. ( Old dairy farm).

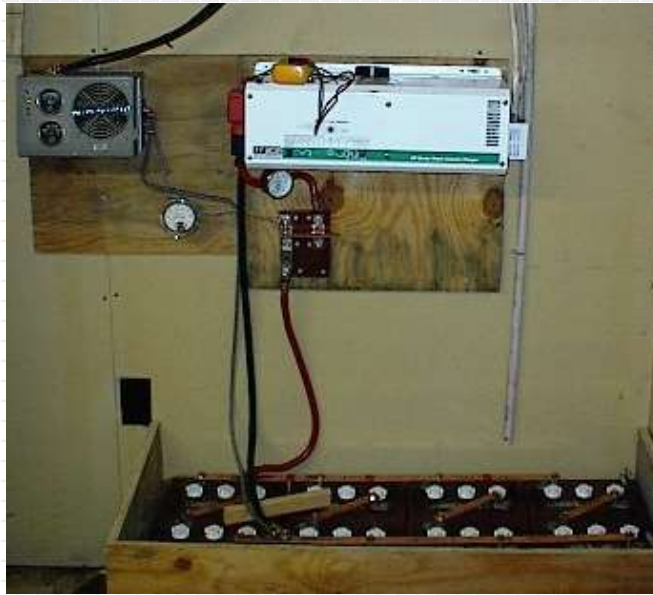

I found an old amp meter from a phone company power box so I added that into the line. The meter under the inverter is a 0 to 600 amp induction type meter that's clamped onto the Pos line to the inverter. The battery box is basic 3/4" plywood with a top that seals quite well. The tube to the right of the inverter is the vent going out through the ceiling ( safety gassing ). Under the Inverter is a 300 amp fuse and disconnect. The entire wind system cost just over \$500.00 including batteries, wire, pole to mount the turbine on, the wind turbine and all other misc connections. The inverter on the other hand cost me \$950.00 which left me with just under \$1500.00 in the whole system. I plan to add another wind turbine to the system as a redundant precaution... they both couldn't possibly go down at the same time..... could they?

# 3 Phase Basics

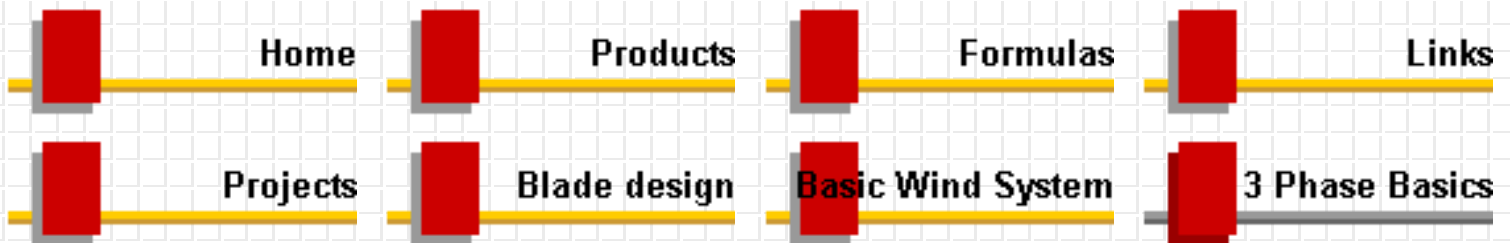

## Understanding 3 phase alternators....

Three phase is nothing more than single phase with 2 extra coils slightly out of phase with first. Basically "Phase" relates to the timing of the magnets passing over the coils at different times. With single phase the magnets and coils all line up with each other and are said to be in "phase". The diagram below shows single phase wiring....

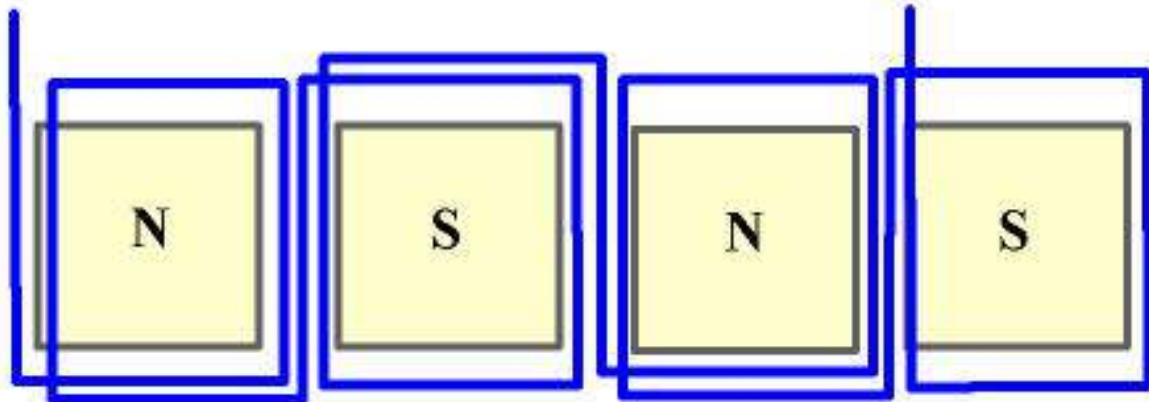

In a single phase unit the coils are wound opposite of the first. That is to say one is wound clockwise and the next is counter clockwise. If your unit has 8 magnets then it would also have 8 coils. With 3 phase you would have 3 coils for each pair of magnets. A pair meaning one north and one south magnet. There are many combinations for any one set up. For instance you could use 8 magnets and only have 6 coils without overlapping them...

or 3 set of 4 coils in series. For now we won't worry about the combinations and stick with the basics. Below shows a diagram of 4 magnets with the placement of each of the coil sets...

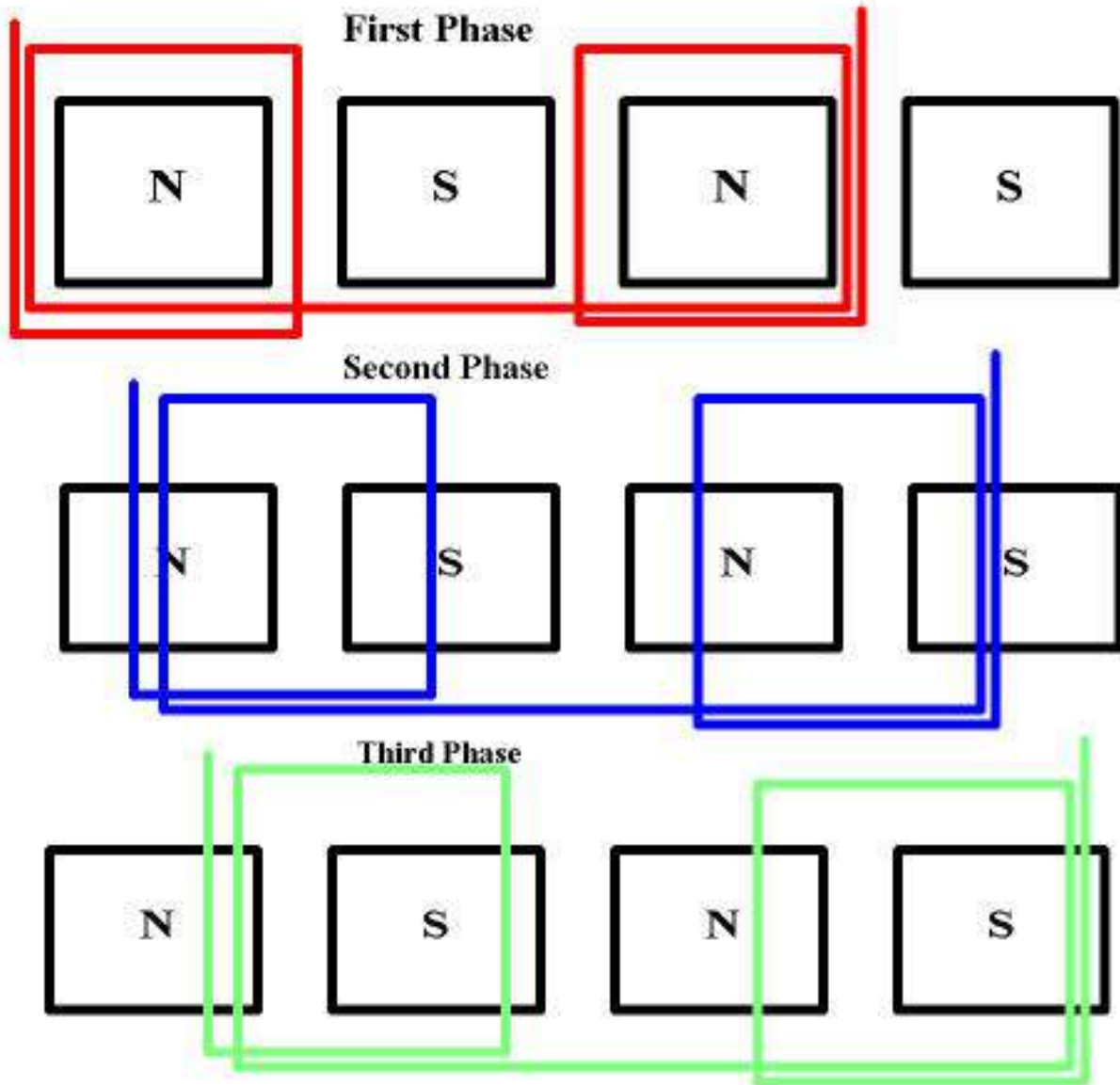

As you can see the first phase covers only the north pole magnets and are wound all in the same direction. The other of the two are identical to the first with the exception they are offset equally. The next diagram shows all the sets in place for a 4 pole alternator. You end up with 3 start wires labeled A,B,C and 3 end wires labeled D,E,F. The output wires to this arrangement would be A, C and E. The reason E is an output or ends up being a "start" wire is because when the magnet passes over the 2nd phase its out of phase between the 1 and 3 so the ends are reversed instead of winding them in the opposite order.



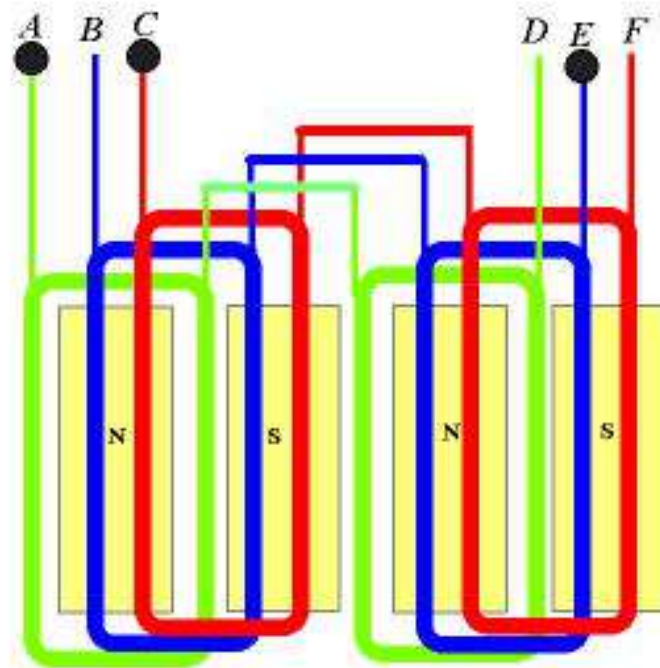

Now to connect the ends and change the AC to DC for battery charging... Below shows the star and delta symbols and 2 different types of rectifiers. Either rectifier can be used for star or delta. You can use diodes and make your own rectifier set up or you can purchase the standard rectifiers. Notice on the standard rectifiers one AC lead isn't used. Similar to the diodes, a rectifier that is already made up for such use and my personal preference is a unit from a GM alternator. They seem to give the best rectified output out of all of them. I'm not sure why but they do. They are expensive to buy new but usually you can get them from the junk yard fairly cheap. Sometimes get the whole alternator for around 15 bucks. They also make a nice clean set-up.

There are basically two ways to wire a 3 phase alternator, star ( or Wye) and Delta. With Delta you get lower voltage but more amps. In star you get higher voltage but less amps.

You can calculate these by using the square root of 3 ( or 1.732 ). Each coil set is a "phase" of the alternator so when you measure voltage, ohms or current to test one phase of the alternator you would measure the "phase". Once you know what the output will be from one phase you can calculate the "line" output of either delta or star. The line voltage would be measured from any 2 of the 3 outputs. If one phase measured 22 volts in your test and 10 amps then the star configuration would produce 38 volts and 10 amps (  $22 \times 1.732$  ).

The amps remain the same as the phase measurement because the star is basically series'd to another phase. In Delta you would get 22 volts at 17.32 amps (  $10 \text{ amps} \times 1.73$  ).

). If you calculate this out  $22 \text{ volts} \times 17.32 = 381 \text{ watts}$  and  $38 \times 10 = 380 \text{ watts}$ ... so what is the advantage? Typically the resistance in Delta is  $1/3$  the resistance of star. If the resistance of star was  $1.5 \text{ ohms}$  we could calculate the output ( see formula section ). Lets assume the test was at  $600 \text{ rpm}$ , we achieved  $38 \text{ volts}$  in star ( about  $16 \text{ rpm per volt}$  ) so at  $1000 \text{ rpm}$  we would get  $62.5 \text{ volts}$  less battery voltage of  $12.6 = 49.9 \text{ volts} / 1.5 \text{ ohms} = 33.26 \text{ amps} \times 12.6 = 419 \text{ watts}$ ... not to bad. Now in delta we had  $22 \text{ volts}$  at the same rpm ( about  $27 \text{ rpm per volt}$  ). So at the same  $1000 \text{ rpm}$  we get  $37 \text{ volts} - 12.6 \text{ battery} = 24.4 \text{ volts} / .5 \text{ ohms} = 48.8 \text{ amps} \times 12.6 = 614 \text{ watts}$ . Almost a  $200 \text{ watt gain !!!}$  The advantage of star is the higher voltage at lower rpm which means our unit would have to make  $201 \text{ rpm}$  to start charging at  $12.6\text{V}$  where the Delta would require  $340 \text{ rpm}$  to start charging.

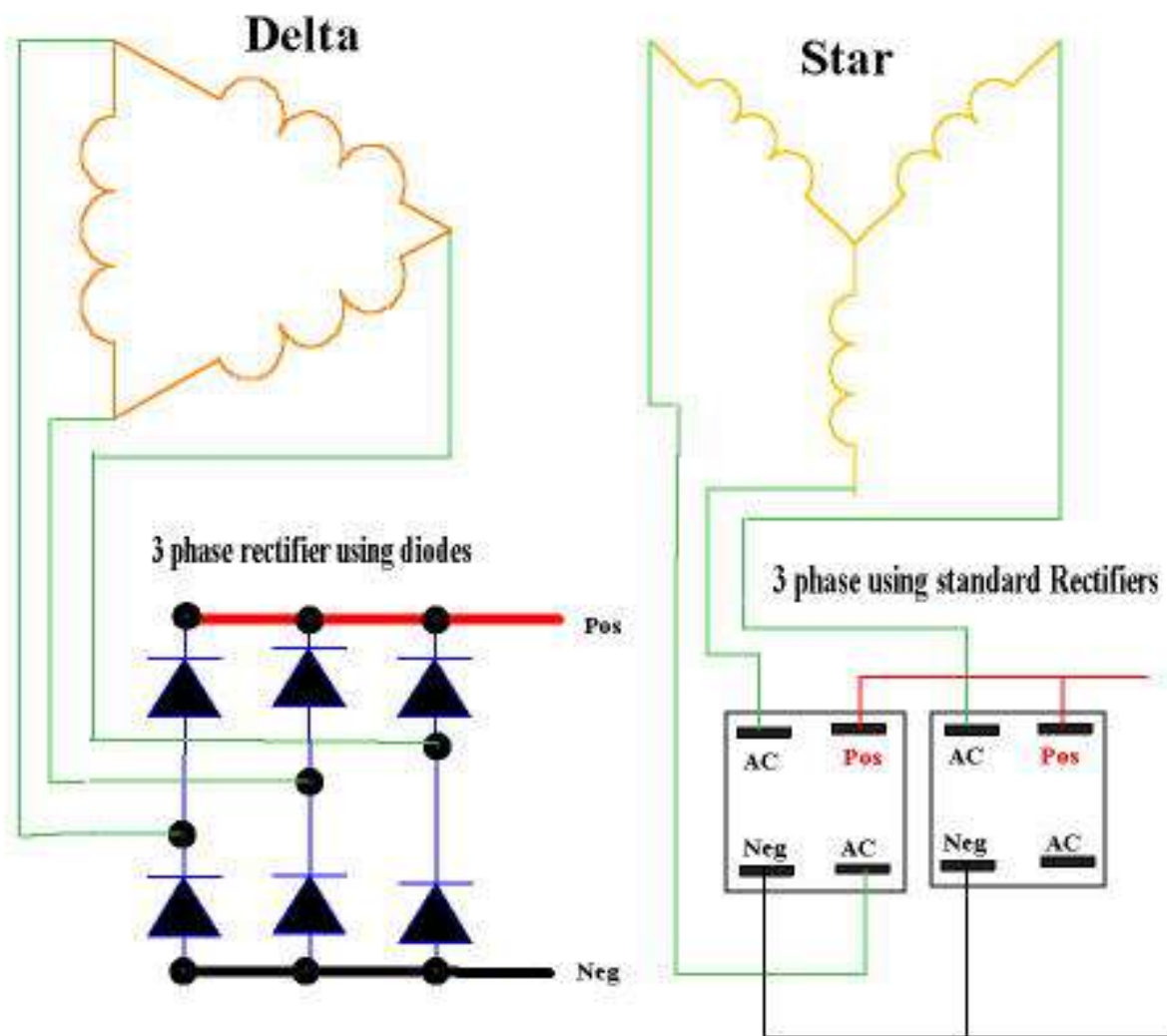

Some Basic factoids about 3 phase.... Most of the electric power in the world is 3 phase. The concept was originally conceived by Nikola Tesla and was proven that 3 phase was far superior to single phase power. 3 phase power is typically  $150\%$  more efficient than single

phase in the same power range. In a single phase unit the power falls to zero three times during each cycle, in 3 phase it never drops to zero. The power delivered to the load is the same at any instant. Also, in 3 phase the conductors need only be 75% the size of conductors for single phase for the same power output.

And there you have it ! Not really much more difficult than single phase but much more efficient !!!

# Builders Corner

[Home](#)

[Up](#)

[Turbine kit](#)

[Builders Corner](#)

[3Phase turbine kit](#)

***Available for a limited time***

***Dual Rotor alternator kit***



**The kit includes:**

**2 8 inch magnet plates with holes completed**

**1 10 inch stator mounting plate holes completed**

**1 Bearing hub**

**2 Bearings**

**1 1 inch shaft**

**1 shaft locking collar**

**1 2" magnet disc spacer machined and drilled**

**24 wedge shaped neodymium magnets**

**And... all the parts below to complete the wind turbine head**



**You'll provide the stator, prop and tail feather as per the instructions below..**

**[Instructions: assembly and building the stator in .pdf format](#)** ( about 1.66mb download)

**Note:** Don't use the 44 turns to lower cut in speed, it will stall the blades and the performance will be lower until higher winds. Use the 40 turn coils. You can increase the blade size to 7 ft and use the 44 turns.

**[Instructions: building the blades and assembly](#)** ( 449kb pdf)

**[Wiring the turbine](#)** ( 140kb pdf)

**The entire kit including all of the above for**

## **\$329.95 + shipping**

These kits will be available for a limited time. If you have questions feel free to ask

This is a trial for these if you'd like to see other options let me know how you want it and I will see what can be done at a reasonable cost

This kit is based on the dual rotor project on the [projects](#) page with the exception of the stator. The stator will be an easy to build and wire 9 coil design...

send an [email](#) if your interested.

**NOTE: when sending an email you must put something in the subject line pertaining to this site or it will be deleted immediately**

Below is a chart showing the performance of the alternator based on a 12volt system. Remember just because it will perform better doesn't mean you should make it do so. I've set the furling at around 28 mph so not to exceed 700 watts.

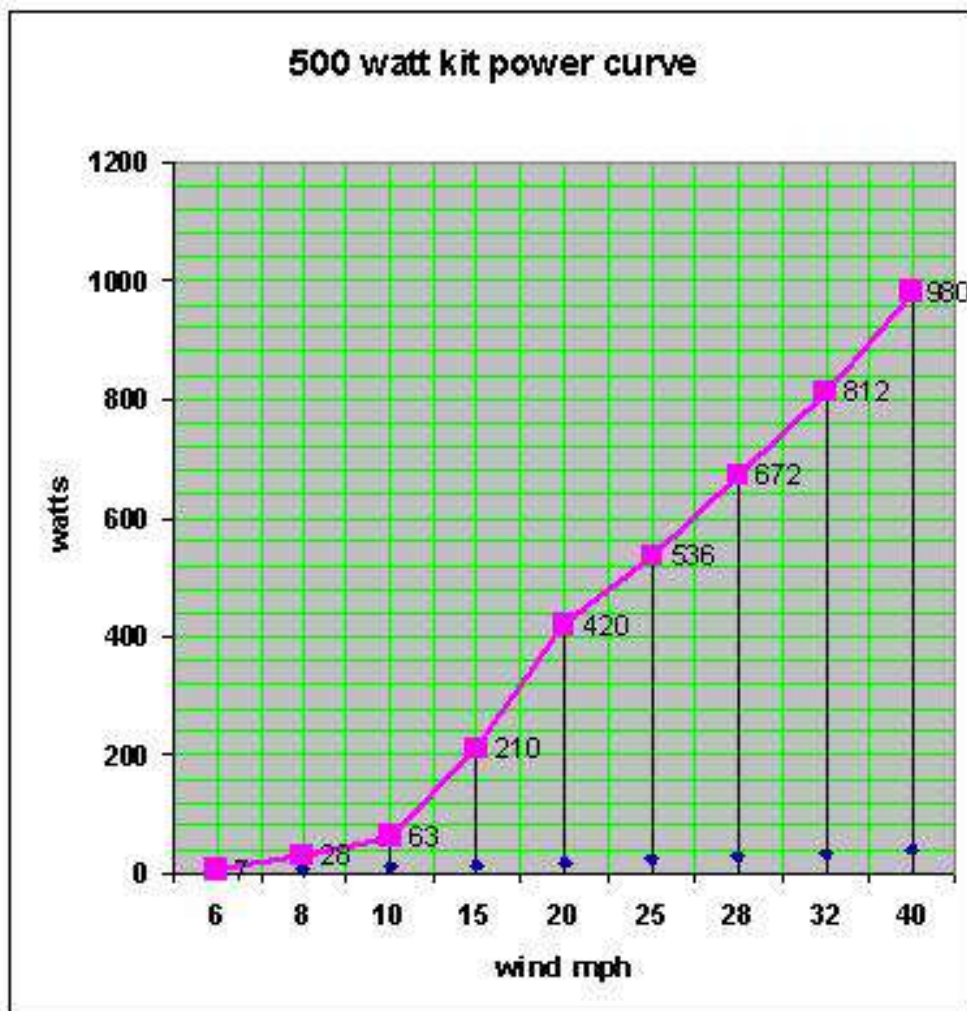

I will be adding things as time goes on so keep checking back from time to time. If you would like to see other items that are not listed send me an email and let me know what your looking for...

### Large Steel Discs



### **Steel Discs**

I have 3 sizes available right now, 8 inch, 10 inch and 12 inch. All made from 1/4" steel plate. Great for prop mounting hubs, magnetic discs for use with an axial flux machine or a combination of both.

**8 inch disc \$11.95**

**10 inch disc \$14.95**

**12 inch disc \$19.95 out of stock temporarily**



There is no center hole in these but I will mark and center punch them so it will be easy to find and drill the center to any size you desire. If you know what size hole you need I can drill them for you but there will be a \$5.00 set up fee.

## Very Large Neodymium Ring magnet sections

If your looking at making lots of power... and I do mean LOTS you may want to investigate the neodymium magnets I've been using for testing. These are custom made and 16 magnets make an 8 inch OD ring with a 4 inch ID. They are N35 grade neodymium and measure 1.57 inch at the top, .78 inch at the bottom and are 2 inches tall. These are 3/16 inch thick. Below are some others but in 1/4 inch thick.

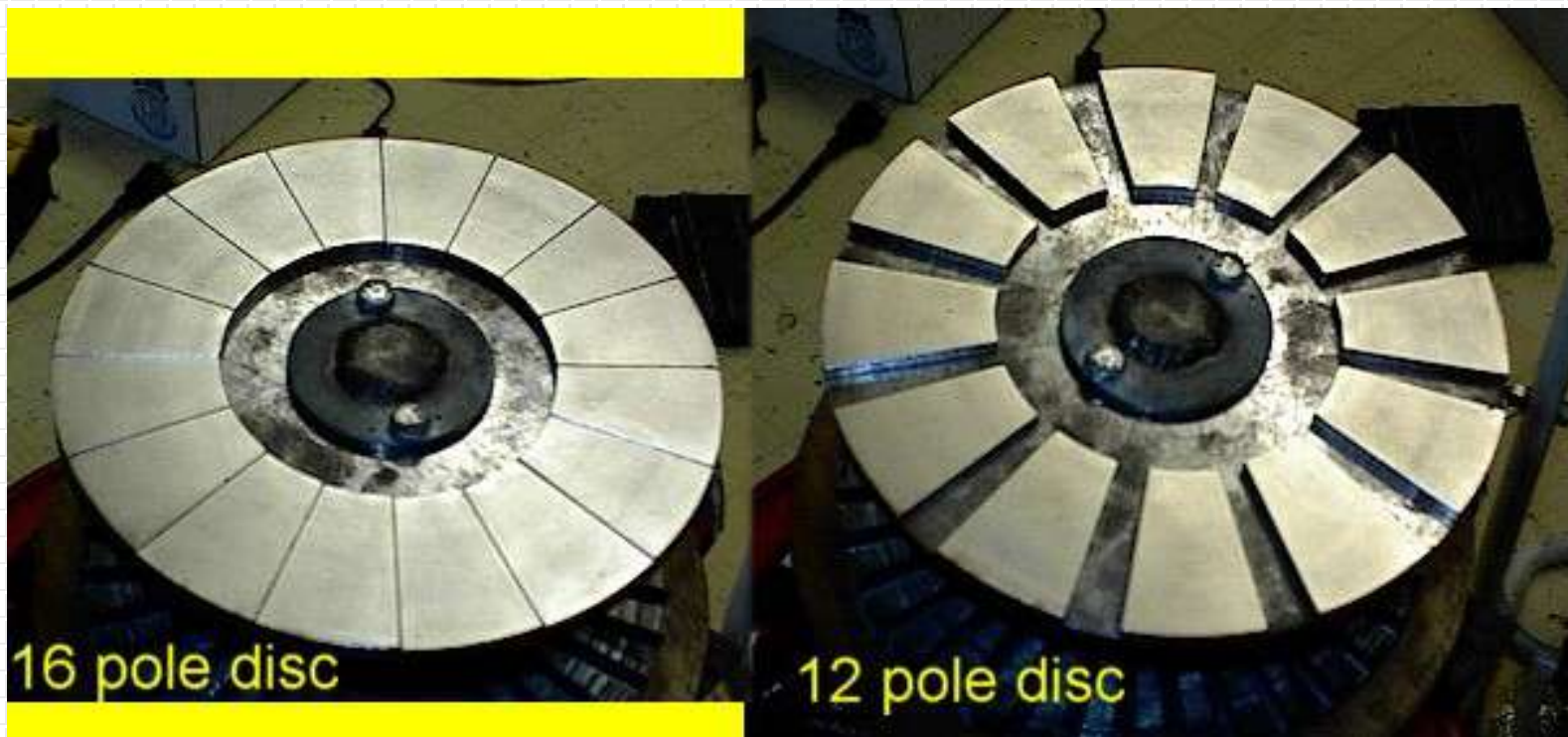

The above shows the magnets mounted on an 8 inch disc using 12 or 16 poles. They also fit nice on a 10 inch or the 12 inch discs I sell above.

**NOTE: Under no circumstances should you attempt to assemble the rings without a steel backing. They are near impossible to get apart without destroying the magnets or your body!!!!**

I have a limited supply of these so you may want to get them as long as their available.

These are rather expensive and are priced as follows...

**\$5.50 each (normally 6.50 each)**

**==> Continued special pricing <==**

**\$8.15 flat rate shipping on any quantity in the US!!  
Great time to start a project or stock up!!!**

*Flat rate Shipping included in the continental US otherwise inquire about shipping costs.*

**\$88.00** set of 16

**\$132.00** set of 24

**\$176.00** set of 32

**( while they last !!!)**

**Also, for a limited time I have the magnets as above only these are 1/4 inch thick and are priced as follows**

**\$100.00** set of 16

**\$150.00** set of 24

**\$200.00** set of 32

**(\$6.25 each )**

***Paypal payments accepted to [elenz@windstuffnow.com](mailto:elenz@windstuffnow.com)***

If your interested in any of these send an email to [elenz@windstuffnow.com](mailto:elenz@windstuffnow.com)

**Note: you must put a message in the subject line relating to this site or your email will be deleted and therefore not answered.**

## Dual rotor wind turbine

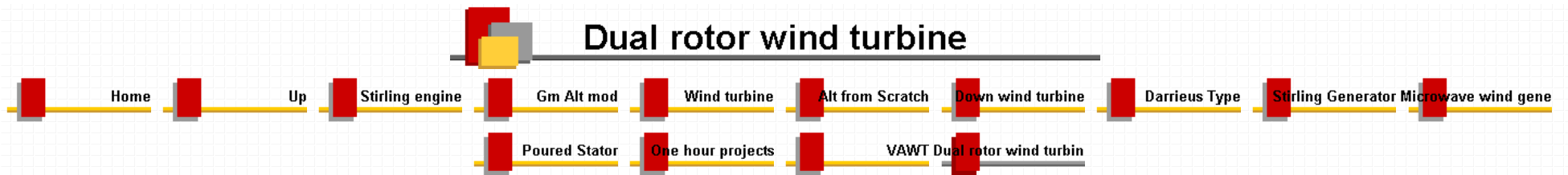

This was one of the projects this summer as a part of upgrading my system. Quite fun although I'm glad the system is back together and completed....

Below shows the 2 magnetic discs using the triangular neodymium magnets listed in my builders corner page. Each disc has 12 magnets on them and are installed face to face. ( Very carefully I might add ). The magnets used are the ones on my [Builders Corner page](#) close to the bottom.



The stator was started by pouring liquid plastic in a mold to form a solid ring. Then it was jiggged into a rotary table. 36 holes were drilled in the plastic then the top portion was opened up with a slotting saw to get the wires into the holes...

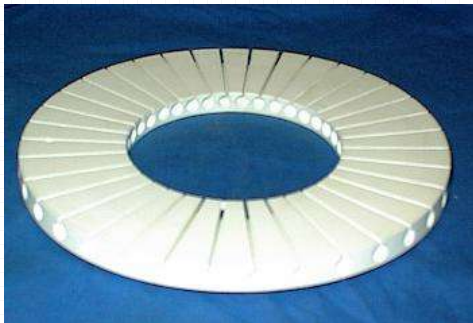

After all the machining was completed I cut some wooden dowels to slide into the holes. This holds the wire out of the way of the other holes when its time to install the next phase...

## Dual rotor turbine

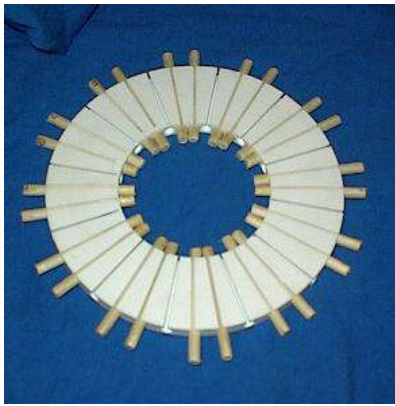

The stator has 36 slots and was wound with 10 turns of #14 wire per coil, since each slot shares 2 coil legs there are 20 wires in each hole. It came in at 0.42 ohm wired in star.

The next picture shows the stator wired and ready to place in the mold and fill it full of plastic again making it a solid mass...

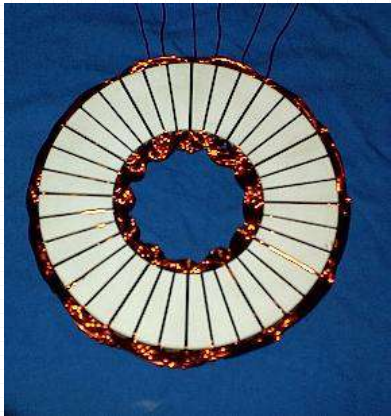

Unfortunately, I didn't take any pictures of the final pouring process or the stator as it came out of the mold. I was in a bit of a hurry at the time and it completely slipped my mind.

Below is a picture of the stator wired with a magnet over it showing the placement of the wires in comparison to the magnet...



The next picture show the head assembly together as it was tested in the lathe. The discs are 8" diameter and the stator is mounted to a 10" disc ( the stator was 10" od also). From the front magnet disc to the back of the backing plate measures 2 inches thick. The stator is 0.625 thick itself. A fairly compact unit...

## Dual rotor turbine

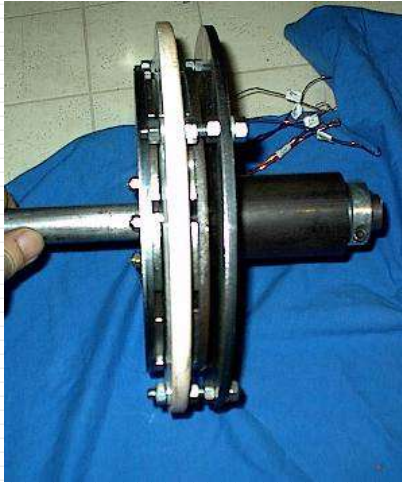

The head assembly just prior to installing the tail and putting it on the tower. I installed a sheet metal shield around the top and sides for those winter days that rain and freeze... hopefully it won't freeze and lock it up. As long as its running its not a problem because the stator stays warm enough to keep the rain from freezing... an untested idea...

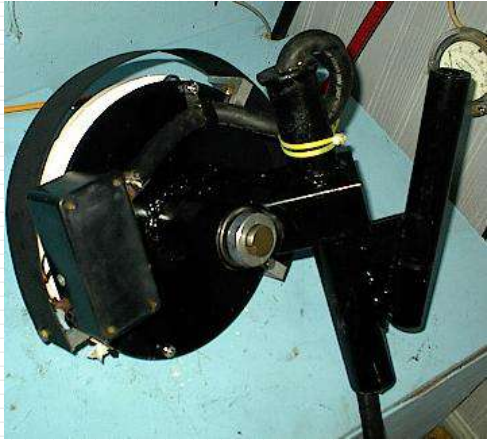

The blades are 6.5 ft diameter and all were installed on a rebuilt aermotor tower. You can see below my little green helper pushes the tower up without any problem. The tower is smaller than I would have liked and came in at 27 ft.

## Dual rotor turbine



And finally she's up and running.... It does a fairly nice job so far... I've seen 42 amps out of her in a 26 mph wind so far which at the time my batteries were at 13.5 volts which comes in at 567 watts. I expect it will do 600 watts with no problem. I've set the furling at around 28 mph although we haven't experienced winds that high as yet and I haven't had the chance to see if I was correct in my calculations.... I'm sure I'll find out soon enough...

**UPDATE:** A fairly windy day gave the little unit a good exercise. I found that my furling system calculations were off by 4 mph and instead of 28 mph it furls at 32 mph. At 32 mph and partially furling it was making 58.6 amps into my battery bank which was at 13.9 volts at the time or a total of 815 watts. A little better than I had expected, and quite possibly more than I want... I'll be taking a couple pounds off the tail on the next calm day...



***The 500 watt alternator kit is available for a limited time... [click here for details](#)***

This alternator will be offered as a kit on the builders corner page

email me for details....

# Dual rotor turbine



Below shows the basic parts breakdown of the dual rotor turbine without the prop hubs or prop

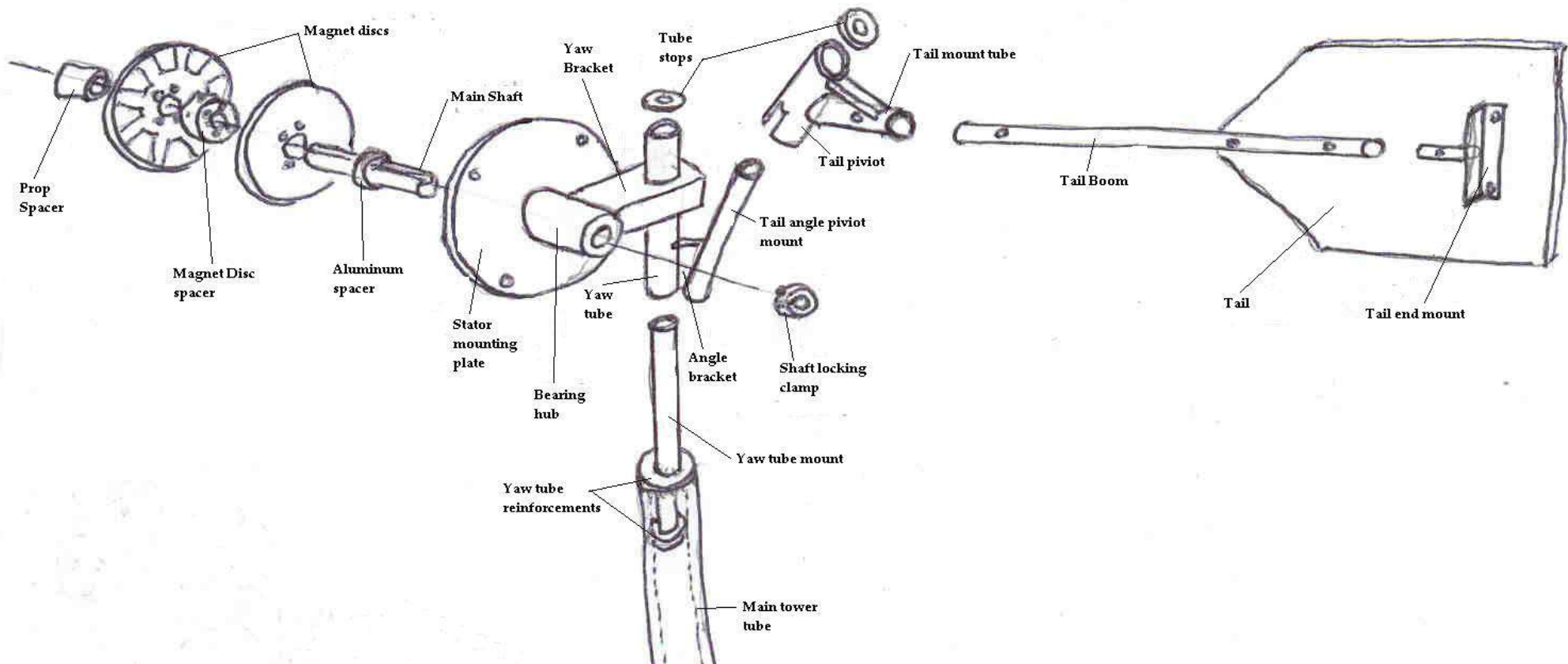





# VAWT

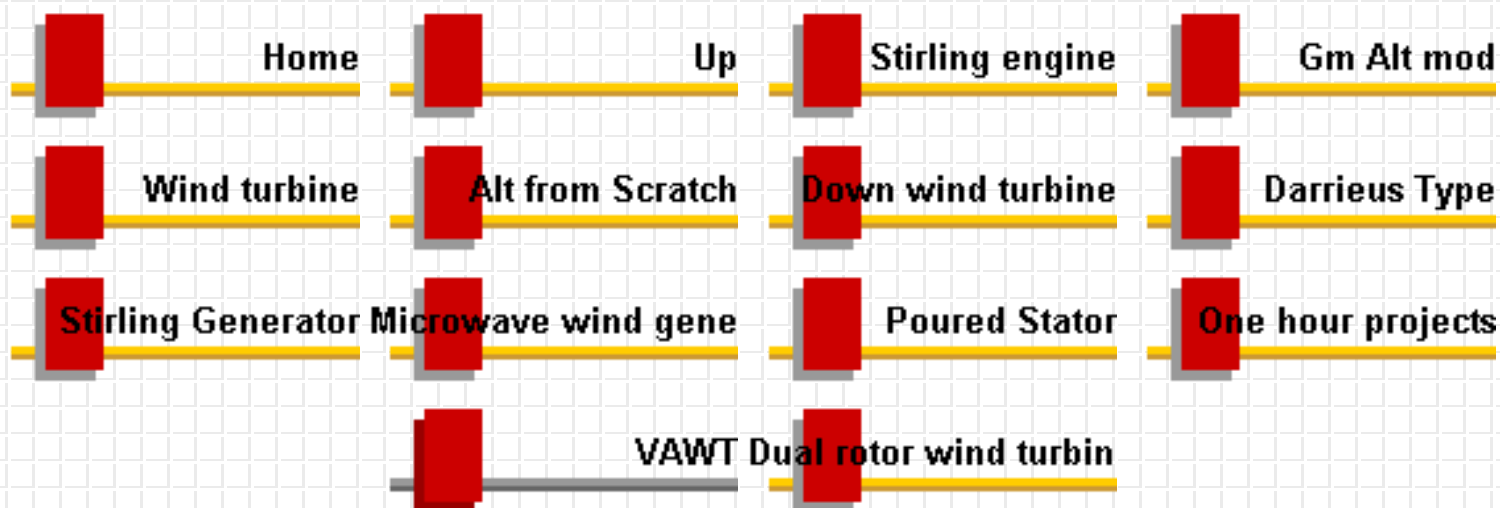

## Yet another VAWT..... *The "Lenz Turbine"*

I've always had sort of a soft spot for the Vertical Axis Wind Turbines because of the advantages they offer. Unfortunately, most of them such as the Savonius aren't very efficient but do offer low wind characteristics. About a year ago I was emailed a patent of a VAWT that was a bit different. This one used the "Venturi effect" to duct air around the wings. After reading through the patent I decided to build one and see if it was any better or worse than some of the others out there. As it worked out it did outperform the Savonius but still seemed a bit low on the overall efficiency. I started searching for any others that used this principal and found one other like it. I ended up building this one also and found similar characteristics but this one also seemed a bit low on the efficiency return, still it did outperform the Savinous again.

I started playing around with small units and built a coffee can model which ended up running at 700 rpm and was named the "700 RPM Coffee can". It really didn't make much power being as small as it was and was basically cut and duct taped together. Below shows a picture of the original coffee can experiment... If you decide to try this be advised the metal is very sharp and you should wear gloves as well as observing all safety precautions...



Basically I divided it up into 4 sections, cut two out and taped them back into the can on the two remaining sections. It ran at 700 rpm in a 12.5 mph wind.

I decided to build a larger one using a plastic 5 gal bucket and similar techniques were used in the construction. This was a real dud! It didn't work at all. After some thought as to why it wouldn't work I decided to try a round drum in the center. I stacked a couple large coffee cans inside and taped them in. By changing the airflow through the unit it worked although not very well.

After trying a bunch of different drums and shapes I decided to get a bit more scientific in my testing instead of my hit 'n miss style up to this point. I was intrigued as to exactly what was going on. I started doing some static tests of the air flow through the machine while in different positions but not spinning. Using a hand held wind speed meter I checked the wind speed in front and behind the unit as well as inside. The air flowing through the can was actually faster than the air entering the can. I found some Venturi formula's and started testing shapes and wings. I figured I had enough information to design something a bit larger, and get some better test results. Using a combination of Savinious design ideas along with the venturi theory I came up with a design that is a bit different than the normal. Although similar to the Darrieus, wings similar to the Savonius, and a triangular drum in the middle to guide the flow of air the design was set. I built a few smaller versions for testing and the results looked promising and showed that I seemed on the right track. A larger one needed to be built. Below is the last one built to this point... Simple construction using plywood and aluminum flashing the machine is a bit under built but all the components are in place for the testing...



The alternator is a homebuilt single phase axial design and the first test run showed 17 watts in a 12.5 mph wind. The alternator serves as a pony brake, the stator has bearings and is allowed to rotate, has an arm attached with a spring scale for taking torque readings. From there the output is calculated. The unit stands 2ft tall and 2ft in diameter. I would say it would come close to competing with the Horizontals. It will start turning in a 3mph wind although the alternator doesn't start charging until about 5-6 mph. The turbine ran 240 rpm while driving the 17 watt load which comes out to a TSR of about 1.3. Static testing with my wind meter and unit not turning, 12.5 mph in front of the machine about 3mph 1 ft behind the machine but 17 mph going through the wing. I think there is still a considerable amount of work in improvements to be done and testing will continue. I'm calling it the "Lenz Turbine" and giving credit to all those before me for their unique and innovative work in this field. Also, to Hugh Piggott for helping me with the formula's for working out the wing angles based on the Darrieus type.

Below is a diagram representing the dimensions for the machine above based on percentages of the overall size for those who would like to build one for their own personal use and/or for testing purposes.

Wing Width = diameter x .14

Wing Chord = circumference x .09

Center drum radius = diameter x .28

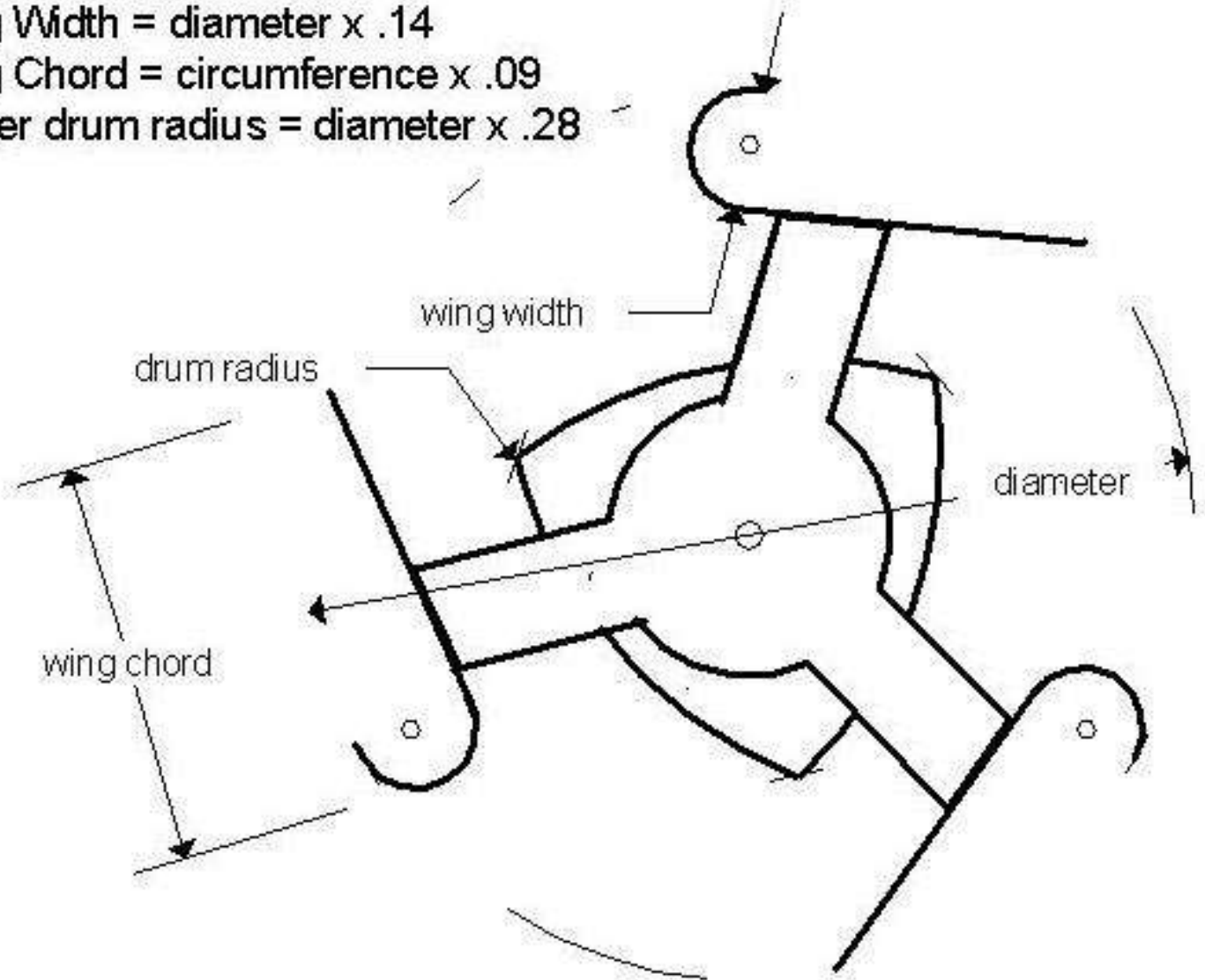

## ***Lenz v2 ... update 8/28/05***

Another update to the fascinating world of VAWT's, the Lenz 2 is a larger wing version of the first and the center drum was removed. Although its only been run in low winds to date the performance is quite impressive for a small machine.

Below shows the beginning of the second version. Using parts from the first one and some quickie fabrication for the wings I began testing the unit. The alternator is a 12

**pole 3phase machine I made up just for this project.**

**It took some tinkering to get it where I thought it should be with good and not so good results.**

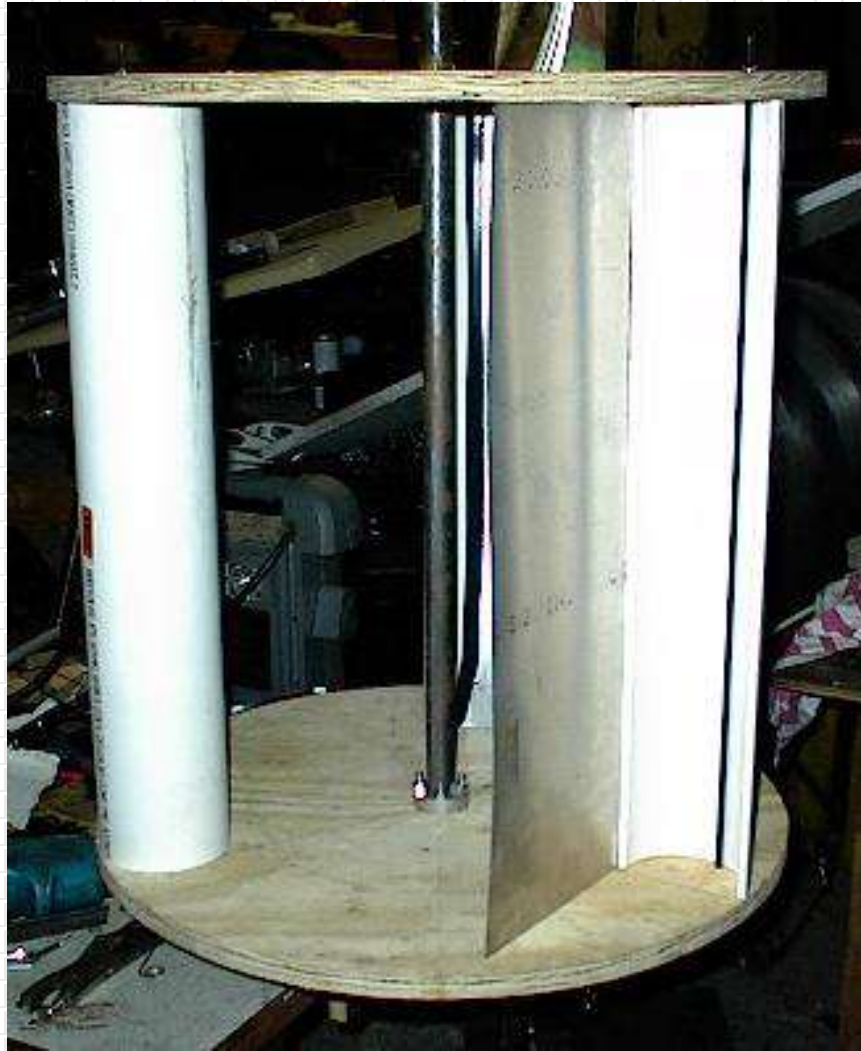

Since the unit was slightly different than the original my wing angles didn't work out real well. I played with one wing on the machine to find out where the torque was as it progressed around the 360 measuring every 10 degrees. I realized at that point the torque wasn't where I had thought and started playing with wing angles again. Finally it was dialed in at 9 degrees and worked like a dream!

It was time to take it outside for some real world testing. I mounted it on the front loader of my tractor and out in the wind it went.

The wind was dying down by the time I got it in position so I really didn't get a chance to give it a work out. Below are some output readings...

5.5 mph starts charging

7.1 mph 3.32 watts

8.5 mph 5.12 watts

9 mph 5.63 watts

9.5 mph 6.78 watts

Not to bad for a small 2ft by 2ft machine.

It was time to build a larger one to see if it could be scaled up and still maintain its efficient run.

I built up a larger one 3ft dia x 4 ft tall unit shown below..



I'm not going to get into a lot of details but it does 52 watts in a 12.5 mph wind. I'm not one to be impressed easily, this machine has definitely impressed me. Now, Its time to take it to another level...





# 3Phase turbine kit

Home

Up

Turbine kit

Builders Corner

3Phase turbine kit

## Educational Three phase turbine Kit



This kit comes with everything you need to assemble a 3 phase wind turbine. Including easy step by step instructions to build and wire it. The kit also includes 6 powerful neodymium magnets.

**All for only \$29.50 plus 4.95 shipping**

**In stock and ready to ship!**

**NOTE: All parts are in stock, all back orders have been filled. And future orders will go out immediately. Thanks for your patience!**

**( shipping is in the US only - send email for calculating shipping to other countries)  
elenz@windstuffnow.com**

The turbine stands approximately 8 inches tall and is 6 inches in diameter. Although not a real powerhouse, it will charge ni-cad batteries and run LED's without a problem. Only basic tools are needed for assembling the kit such as a drill, various drill bits, 7/16" wrenches, #1 phillips screwdriver. You will also need some tape and super glue.

Winding the coils has been made easy, using a slightly different approach that anyone can do. The slotted stator makes it very easy to hold the wires in place

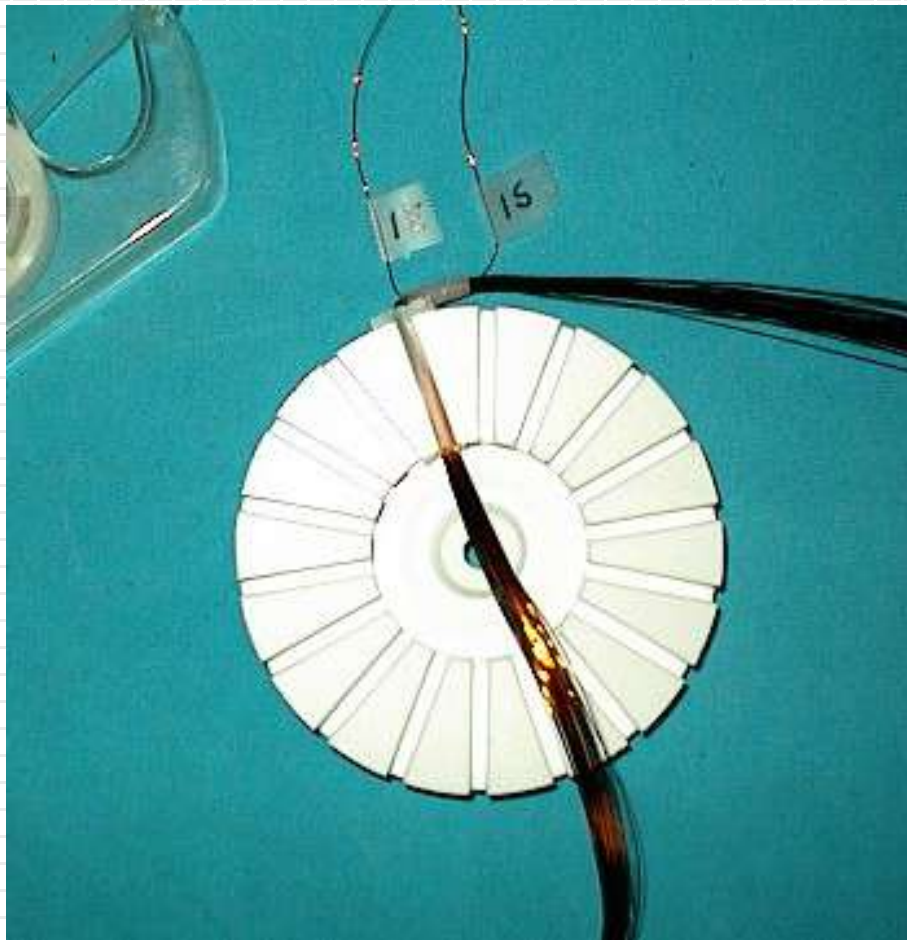

The base is up to you and can be a simple board with feet or a PVC plug to mount it on a pole.

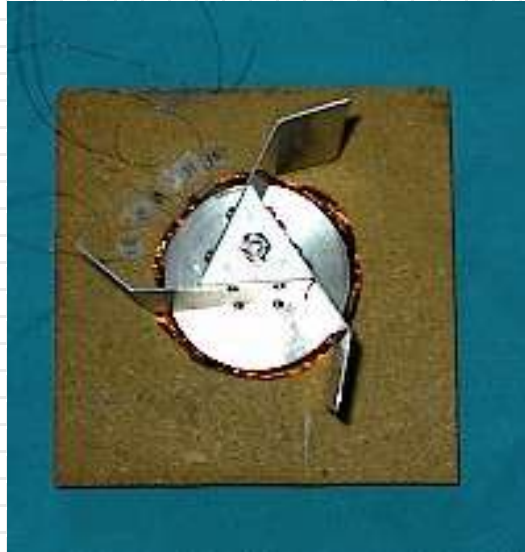

Very simple and fun to build!!! Order one today. If your an educator ask about quantity discounts so all your students can learn.

You can download the instructions to see if its something you would like to build. The instructions are now in PDF format which makes it simple to print and use

[Click here for the download \(50k\)](#)

# Alt from Scratch

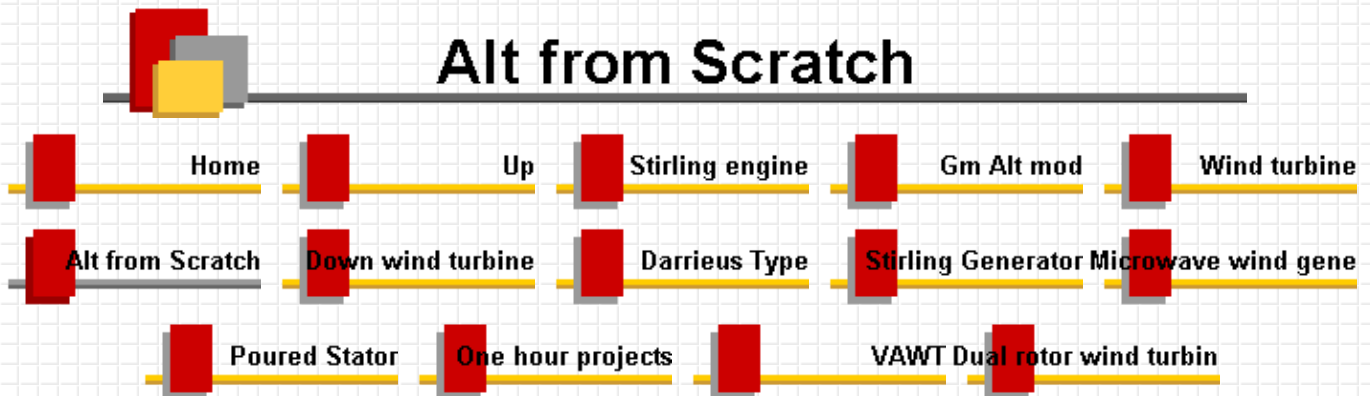

## Scratch Built Axial Field Alternator

I built this alternator from some emails I recieved about direct drive units and lowering the RPM per volt. I've done a few chain drive units that work well but they have their drawbacks. Problems relating to drive losses, they require higher winds to start, and have higher maintenance to name a few.

My goal, once again, was to keep it as simple as possible so others could build one with basic tools and could be done relatively cheap. I believe what I have here accomplishes these goals.

Since Radial flux type units require specifically sized parts I chose the Axial Flux type. One of the things in the back of my mind was the "cogging" effect created by most of the PM alternators and the amount of wind it takes to start it. During the thought process for accomplishing this project I needed to either make it an "air core" or come up with a way to hand build an iron core. The "air core" type isn't very efficient in the sense that the coils aren't saturated properly when the magnets pass the coil. In order to cure this problem you would need 2 disc's with magnets on them. This would complicate the design so I started looking for other ideas. On first thought I pulled out a roll of mig welding wire and thought about rolling a "core" from this. Unfortunately, this would require a special jig and a way to separate the wires from each other. I started looking at laminations from motors, transformers or what ever I thought would transfere flux fairly well. It dawned on me that sheet metal could be used in this part of the project. I cut strips of sheet metal and strips of cardboard and coiled them up until I had a piece the size that I needed. I used Fiberglass Resin to "lamine" the coil together then glued it to a 9" disc made from 3/4" plywood. Below shows the disc and laminations glued in place.



The steel coil was glued to the wood with JB weld then the fiberglass Resin poured over the steel core. The outside diameter of the steel core is 8" and inside diameter is 5.5". The magnets I chose was Item #27 from [www.wondermagnet.com](http://www.wondermagnet.com). I marked the stator at 20 degree intervals so there would be 18 magnets used on the rotor. The coils had to fit over the 20 degree area and in a triangular form so I made a jig to make the coils. There is 27 coils to fill the rotor for a 3 phase set up. Each coil was 30 turns of #20 wire, and all made in the same direction. Below shows the coils of each phase being placed on the stator.

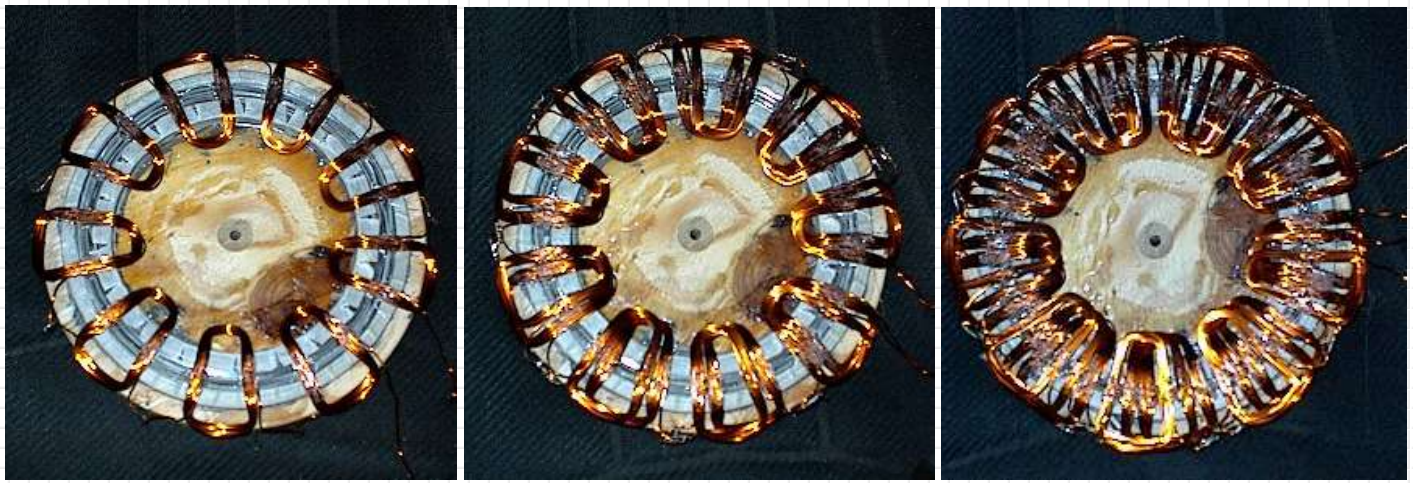

The initial tests of the single coil showed 1.1V at 630 rpm which meant I should get 9.9 Volts from the series of 9 coils. Testing showed 13.5V AC and 22V rectified which was much better than I had anticipated. I laid in all the other sets and soldered up all the connections in series for the last 2 phases of the alternator. This leaves 6 wires loose - 3 starts and 3 finishes to be wired up later. I used a hot glue gun to place the coils before finishing the stator. I reinstalled it on the lathe and started testing it with all the phases in place. In a "star" wiring it made 38 volts at 630 rpm and in a "Delta" wiring it made 22 volts. "Star" gives you more volts but less amps and "Delta" gives you more amps but less volts. I'll talk about the different wiring of it later.

Below shows the Stator filled in with fiberglass resin. This seals the unit and holds the coils in place ... permanently! The other shows the steel disc the magnets are on for the rotor. None of them were glued on during the testing. They are quite strong and are very hard to move. The steel disc the magnets are on could be a disc cut out from plywood with a sheet metal disc laminated to the plywood disc. This would serve the same purpose. The steel behind the magnets intensifies the field going to the core and through the coils.

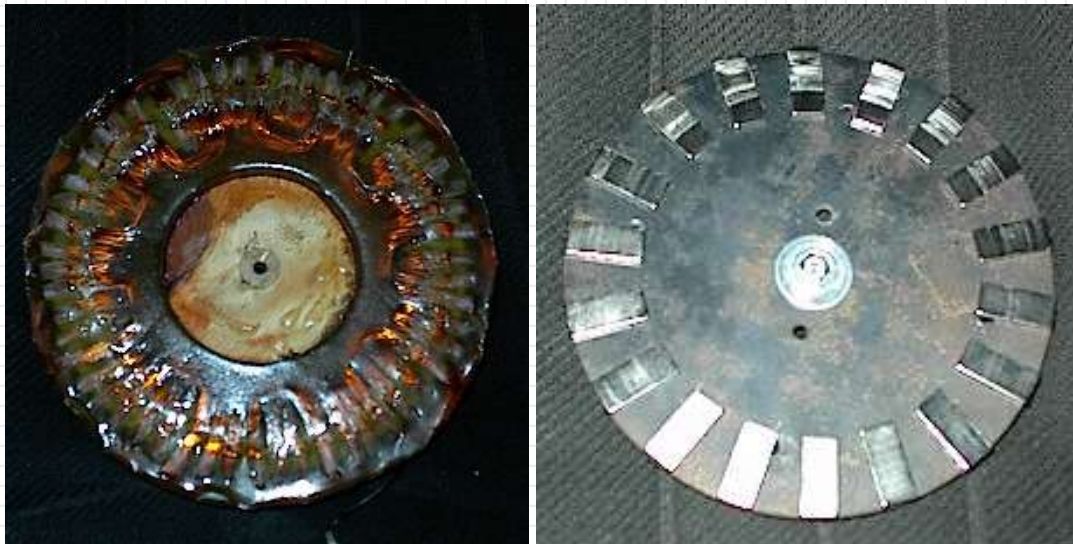

The magnet rotor will be mounted to the prop hub and the stator will be attached to the bearing head. To complete the rotor the magnets are glued in place and resin will be poured onto the plate to lock them in forever then it will have to be balanced.

Now to the wiring.... Here lies a problem, you can wire the alternator in a star configuration or in a Delta. The star gives you much more voltage but less amps and the Delta gives you less voltage and more amps. Below shows the way each of the three phases would be wired....

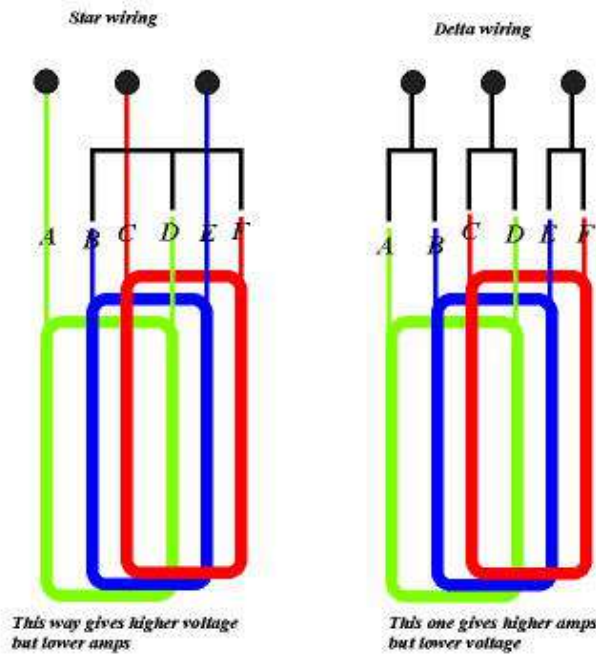

If this alternator is wired in the star configuration it will produce 217 watts at its highest rpm. In Delta could deliver up to 400 watts. Unfortunately, the delta configuration won't allow charging until it reaches 500 rpm which means our windmill won't charge until around 14mph. On the other end the star will give us 76 watts at that speed. It would seem the best solution would be to use them both. I have yet to figure out exactly how to do this.... any electronic genius's out there? I thought of using a relay that would kick in at a certain voltage... but as soon as the relay changes the voltage drops. You could use power mosfets for controlling the wiring change but how to control the transition.... either by using a hall sensor to keep tabs on the rpm.... or build a separate mini generator on the outer rim of the stator for low voltage input to the gate of the FET's.... still pondering that one.... any ideas welcome... send an email [elenz\(nospam\)@windstuffnow.com](mailto:elenz(nospam)@windstuffnow.com) (Remove "nospam") (See below on update for a wind driven relay system)

After exerting many brain cells on this situation ( at least several that I know still work ) I started thinking of different approaches to this Star/Delta dilemma... First was a thought on an aircraft ASI ( air speed indicator), this uses a diaphragm to exert pressure on the needle drive system through the use of a "pitot tube". Assuming you could figure out the size of tube and diaphragm to exert the right amount of pressure at a certain wind speed to move the relay, this could work. The drawbacks to this system is the fact the pitot tube could get plugged with ice, snow, bugs etc... not such a good idea. Then down to my last couple cells I thought of using the wind (like the tail) to exert pressure on the relay at a certain windspeed. This seems to be the best I've come up with so far so I decided to go with it ... unless someone comes up with something better... remember it must be simple! Below is a diagram of how the relay would be wired

### Star/Delta wiring through relay

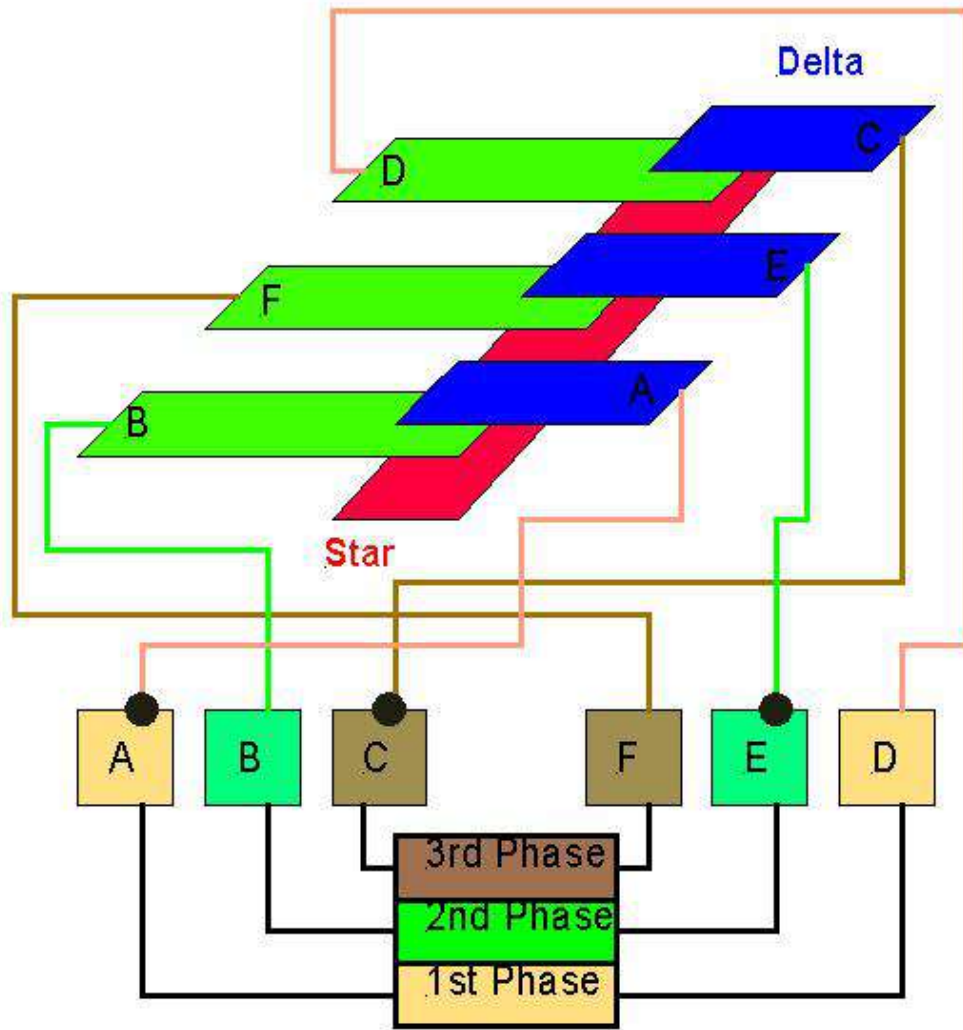

B,F,D are the moving contacts. A,C,E are the output lines. Once they are in contact with the red strip it would be in star configuration and when in contact with the blue strips its in Delta configuration. Make a mental note the 2nd phase of this alternator is reversed. This is because the phasing is off when the coils are stacked in 3's. You still wind all the coils in the same direction and wire them all the same but the start and end wires are reversed. In any case... A small tail would (will) control the movement of the contacts. I haven't as yet built this unit and have no idea if it will even work as yet... its simply a plan... more on it later...

Below is a chart of the calculated performance of this alternator. You can see where the star and delta should interchange for better output.

	Star wire configuration			Delta wire configuration		
RPM	Open V	Amps@14V	Watts	Open V	Amps@14V	Watts
200		12			7	

300	18	1.39	19.5	10		
400	24	3.41	47.8	14		
500	30	5.43	76	17	4.64	65
600	36	7.45	104	21	6.93	97
700	42	9.47	132	24	13.96	195
800	48	11.49	161	27	18.62	260
900	54	13.51	189	31	23.29	326
1000	60	15.5	217	34	27.91	391

Below shows the magnet rotor after the Fiberglass resin was poured in around the magnets and the rotor mounted on the prop hub... The green is a rust resistant coating on all the steel parts that is exposed to the elements. The magnets are placed every 20 degrees and glued directly to the steel plate with aircraft epoxy. ( JB weld would work fine in this application). I used a coffee can lid (plastic) for the center and taped the outer edge of the steel plate to form a barrier to pour the Resin on. You want to make sure the rotor is level when you pour this or it will run to the low side.

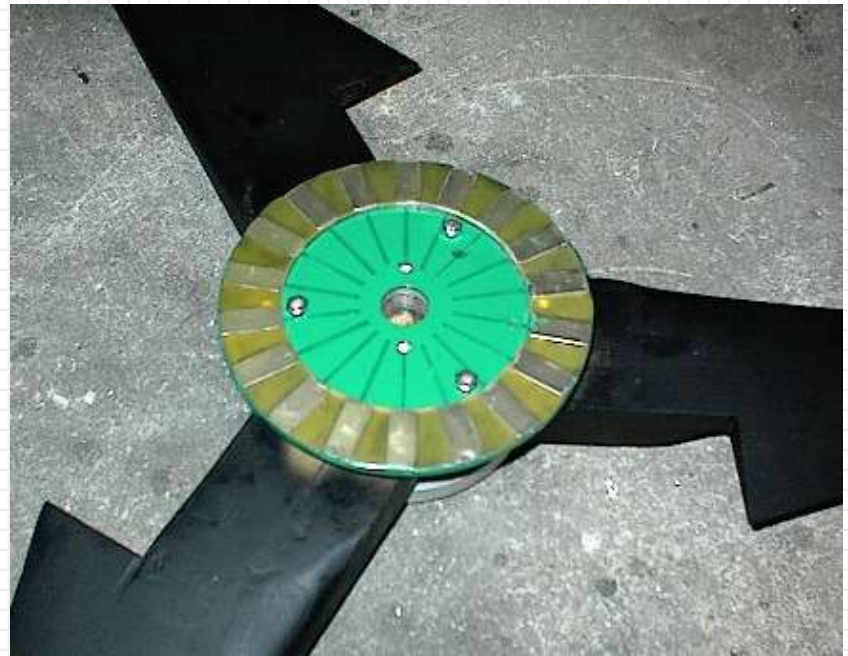
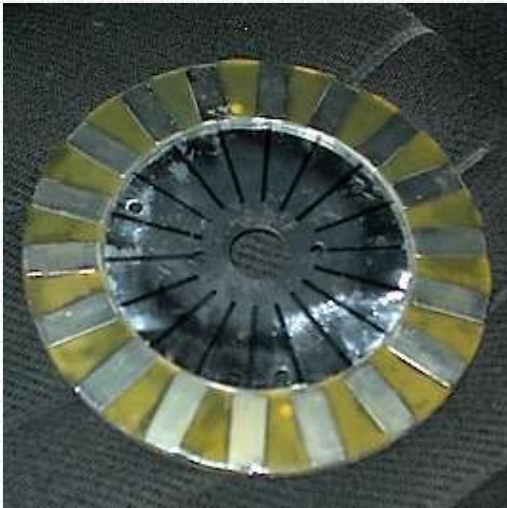

Below shows the stator on the bearing head and the prop on the unit. I still have some finishing up to do before it goes on the pole but the project has come to its final stages. I used a 6 ft prop with a TSR of 8 for this one. Shouldn't be any reason this unit won't produce 400 watts. The prop, during testing in a 20mph wind, leaped to 1000 rpm with no problem ( no load on it ). Very Very quiet too ! Also should start in fairly low winds because there is no restriction (such as cogging) until it comes up to speed to start charging.



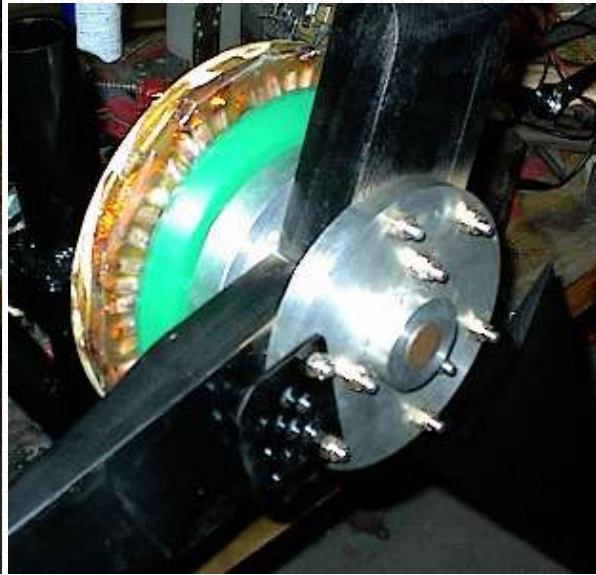

To be continued.....

# Gm Alt mod

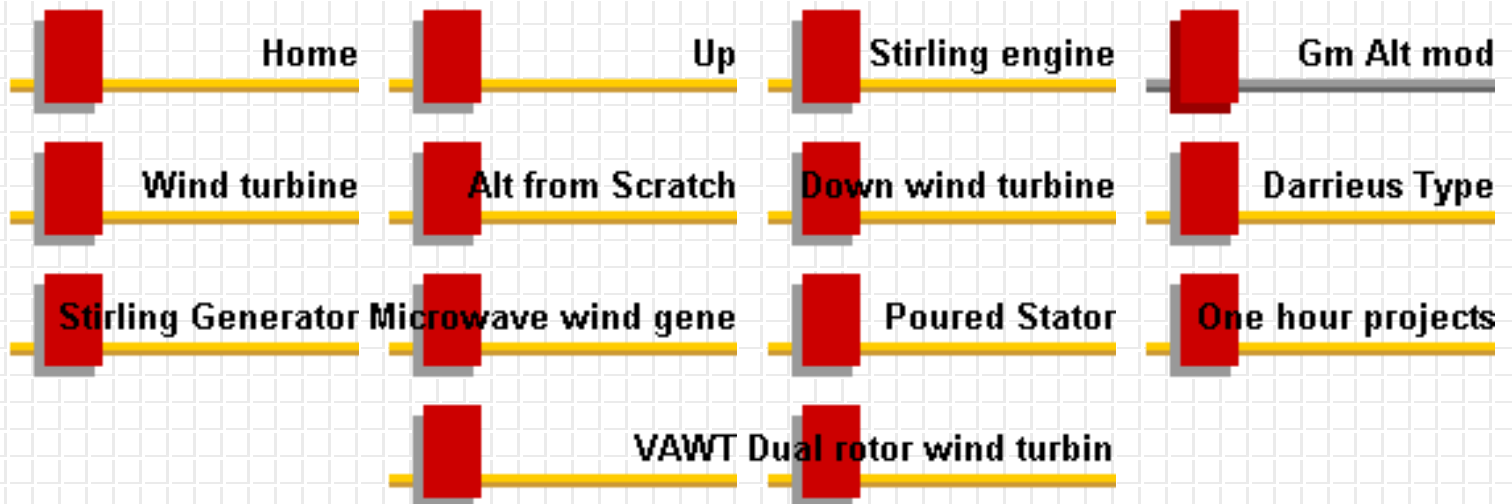

This originally started out as a 37amp alternator from the late 60's to early 70's. I machined the rotor to accept the magnets, then glued them in place one on each "finger" of the old rotor. 14 of them total. Below is a picture of the first rotor. The epoxy I used didn't hold when I spun it up to around 2500rpm. I changed to the Aircraft structural epoxy ( the kind used to hold wing ribs in place ) and this worked very well. In the case you can see the brush assembly was completely removed. There was no need to power the field coil any longer. This unit will now produce 750 watts of power at just under 2000rpm





I had some problems cutting the rotor because of the hardness of the material used for the rotor. I went through 3 cutting bits during the process. I decided to try a different approach on the next one. I pressed the shaft off the old rotor unit completely and made another rotor out of a piece of 6061-T6 aircraft aluminum I had laying around. Although it seems like a bit more work ( starting from scratch ) it actually didn't take as long and I can use the same cutter on other projects also. Below is a picture of the shaft removed from the rotor and the aluminum rotor pressed on the shaft...



Most of the machining was done after the shaft was pressed into the new rotor. The next one shows the soft iron strip cut to fit the slot. The slot was cut deep enough to recess the magnets and the metal strip. The next picture shows the metal strip with a magnet laying in the groove



I roughed up the metal strip with a 20grit sanding disc ( paper with a rock glued to it - its pretty rough ). Then proceeded to glue the strip into place. I used a hose clamp to pull it in place and hold it until the epoxy set up. Actually put it in the oven at 150 degrees for an hour to help cure it a bit quicker.... worked well. The picture on the right shows the magnets in place and the spacing....



Below shows the magnets all glued in place and the rotor is ready to go back into the case....



After the new rotor was installed, the first tests came out quite good. Initially turning the rotor I noticed less cogging with the larger magnets. On the machine it showed 36.1 volts at 1500 rpm. It came up almost another volt from the first one. Amps were similar to the first. This one produced 50 amps at 1850 rpm. I rewound a stator with one size wire smaller and installed it in a case using this rotor and it now produces 50 volts at 1500 rpm but the output amps dropped ( give and take unfortunately ).



Above... all the parts to the completed unit and the unit completed

Below is a comparison chart of the three units I've tested....

	<u>Original modification</u>		<u>New Rotor</u>		<u>New windings</u>	
<u>RPM</u>	<u>Open Volts</u>	<u>Amps</u>	<u>Open Volts</u>	<u>Amps</u>	<u>Open Volts</u>	<u>Amps</u>
300					9.9	
400					13.2	
500			12		16.6	1.7
600	13.9	1.4	14.5		20	4.5
700	16.2	2.8	16.8	3.7	23	7
800	18.6	6.6	19.2	7.7	26	9.5
900	20.9	10.5	21.6	11.8	30	12.8
1000	23.2	14.4	24	15.8	33	15.3
1500	34.8	33.8	36	35	50	29.5

# Stirling engine

<a href="#">Home</a>	<a href="#">Up</a>	<a href="#">Stirling engine</a>	<a href="#">Gm Alt mod</a>
<a href="#">Wind turbine</a>	<a href="#">Alt from Scratch</a>	<a href="#">Down wind turbine</a>	<a href="#">Darrieus Type</a>
<a href="#">Stirling Generator</a>	<a href="#">Microwave wind gene</a>	<a href="#">Poured Stator</a>	<a href="#">One hour projects</a>
	<a href="#">VAWT Dual rotor wind turbin</a>		

## Stirling engine models....

Just a few of my spare time projects... I enjoy building stirling engine models. Here are a few that I've done.



The one on the left is a low temperature stirling. It will run on warm water or even ice. The one on the right is a water cooled stirling with its own water pump.



This one is built entirely from tincans and scrap wood. This unit is quite powerful for what its made from. If you would like to build this model I sell plans for it. The plans are only \$7.50 plus shipping ( add 1.25 for shipping). Simple tools and a steady hand can put this together in about 2 to 3 days. The displacer chamber for example is built out of a hair spray can and a coors beer can for the displacer. A coffee can for the burner and an upside down can at the top for ice or water to help cool it. The rest is quite obvious... standard 3/4" plywood. It will run about 500 rpm and actually could run a small generator, such as a "hankscraft" type PM motor to power a small light or charge a couple of D cell type nicads. If your interested in the plans for this little beast send me an email at [elenz\(nospam\)@windstuffnow.com](mailto:elenz(nospam)@windstuffnow.com). ( Remove "nospam") **Now you can purchase them online using paypal service. Simply click on the "Buy Now" button above.** When payment is recieved I will send you an email with the download site and password to unzip



the file. The File is in MS Word format. Approximately 1.8 Mb

# Wind turbine

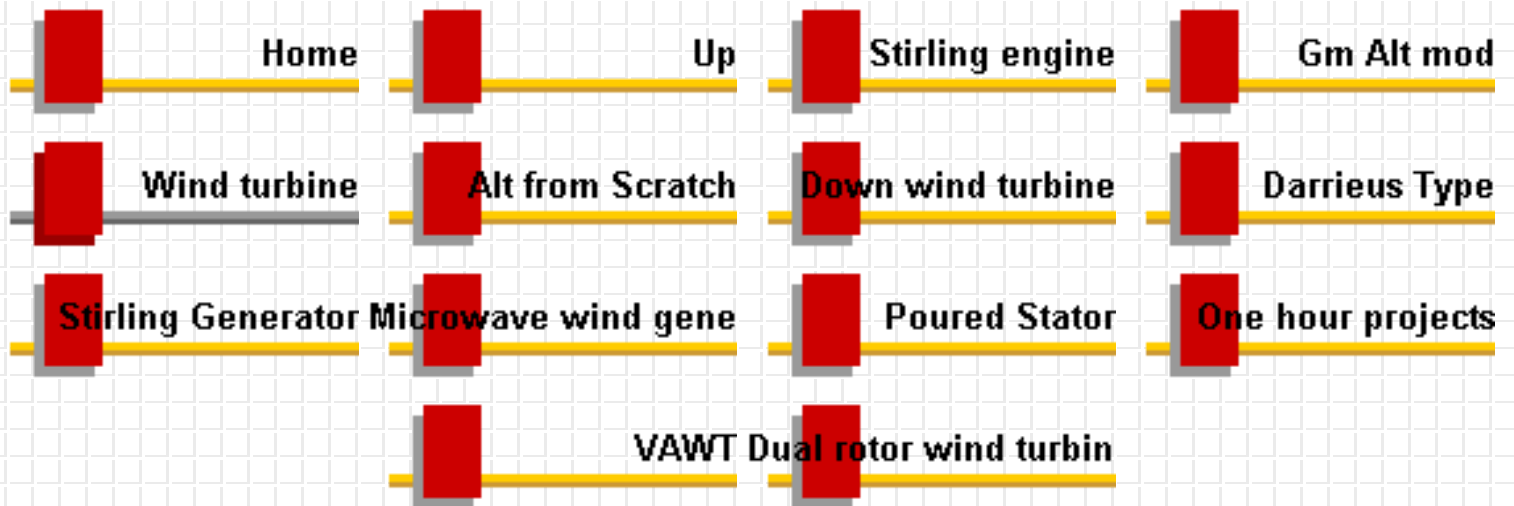

This is the test bed for some of the turbine blades I make. This was actually a modified version from "Wind power Workshop" by Hugh Piggott. If you don't have this book, I would highly recommend it to anyone interested in Wind power.



The only thing that was modified from his original version is the bearing head. Mine had to use the modified Gm alternator instead of the "brake drum" alternator. The above picture

shows most of it together with the blades in place sandwiched between two machined aluminum hub sections. Notice the chain drive sprocket behind the hub?

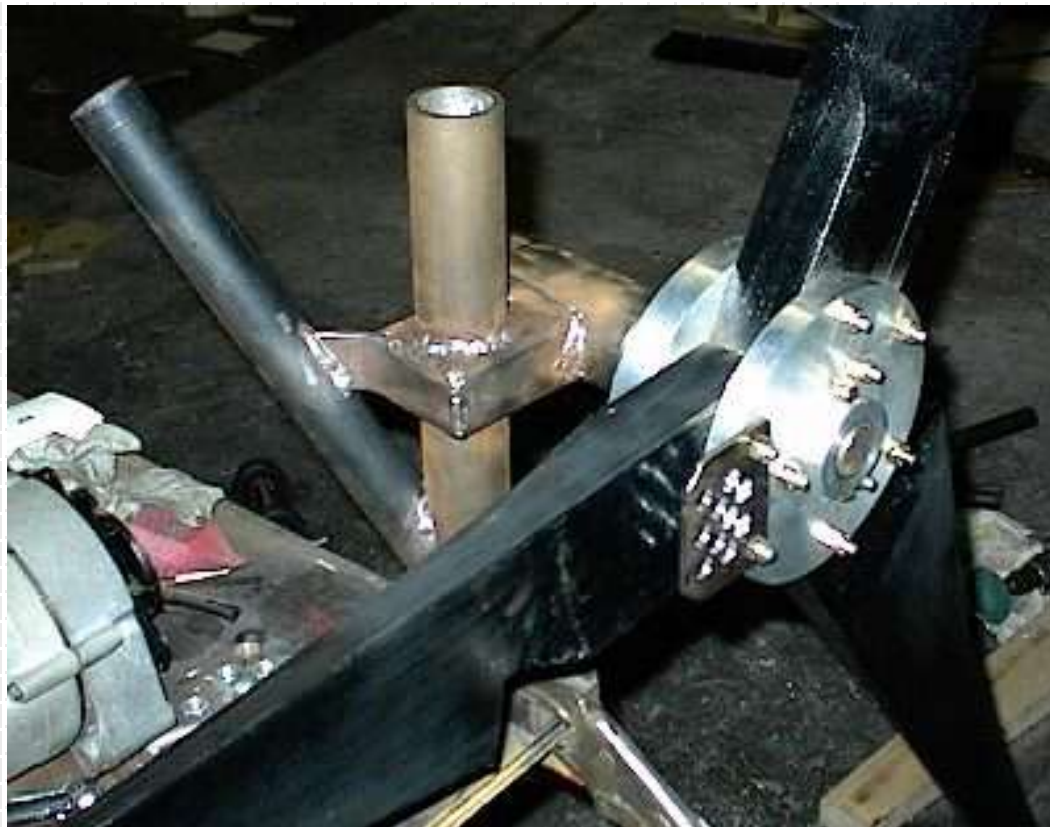

A couple more shots of it at different angles. This one you can see the balancing weight on the hub as well.



All bead blasted and ready for paint. Here you can see the alternator lower mount at the bottom and the upper mount in the left hand picture. The main shaft head was machined to accept a standard 1" tapered roller bearings for a small trailer. Quite inexpensive. I have less than 90.00 invested into this turbine. It will produce 400 watts at a wind speed of

28mph. That comes out to around 22 cents a watt.

I'll try to get some photo's of the completed unit when I get some time. This turned out to be a fairly quiet running unit and it does a very nice job. I actually thought it would be much noisier with the chain drive system. The alternator I used was the "third" of the series of testing.





The above shots were taken just after it was assembled for the first time after all the painting (boring stuff) and misc stuff were completed.

# Down wind turbine

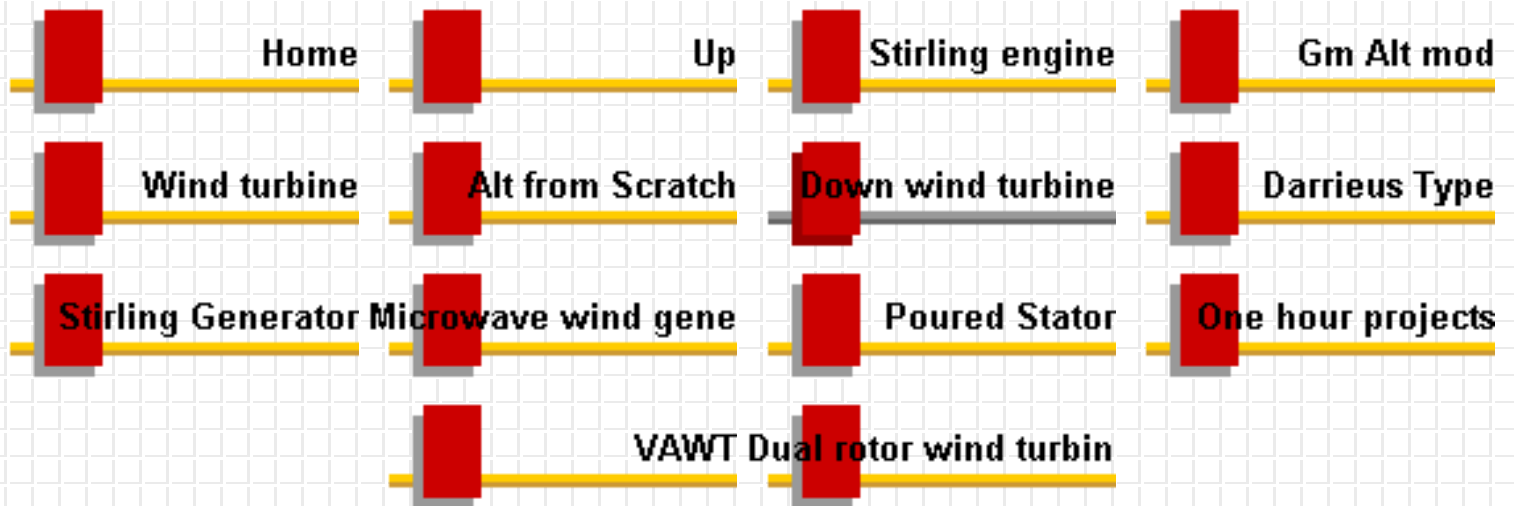

This is the second of a group of downwind turbines that I have been testing. This one has the identical alternator that the smaller one has with the exception of the magnets used.



The first pic shows the magnet used before being cut into 8 equal sections. The next shows the stator after slotting and the magnetic disc.



The next couple show the prop mount, bearing hub, and magnetic

disc apart as well as assembled. There is a steel band around the magnetic disc to reduce the chances of the assembly coming apart at higher rpm. The magnets were mounted to a 8 inch x 1/4" thick steel disc and the band was welded to the edge. Magnets were epoxied into place then the gaps were filled with fiberglass resin.



The 8 inch magnetic disc is mounted to a 9 1/4" x 3/4" plywood disc. The bearing hub and magnetic disc "sandwich" the plywood in place. I used 4- 1/4" aircraft bolts (AN hardware) along with the aircraft type nyloc nuts for safety reasons. Whether they are aircraft quality or not, I would recommend using the nyloc type nuts on any spinning assembly. The only difference between a standard grade 5 bolt and an aircraft bolt is the aircraft bolts have been X-rayed for fractures, bubbles etc, and are guaranteed to be solid. Another note, on an aircraft these would also be safety wired into place leaving very little possibility of the assembly coming apart.

The below picture shows it assembled ( first time up) in a jig in front of a large fan for initial testing.





This one initially had a variable airgap system, star/delta switching, and full furling abilities. After the initial tests I'm undecided at this point if the variable air gap is worth the extra time and work. With the system working it will start spinning in about a 5 mph wind and start charging at around 7. With the system disabled it won't start spinning until around 10mph but instantly starts charging and once started will continue charging down to 7mph. So unless the wind drops below 5mph it will continue spinning.... I don't believe, at least for this unit, the variable air gap has done anything of any significance.

The star/delta switch originally worked off the same system as the variable air gap and has had some problems in the switching stages causing a "chatter". Since I am utilizing the "torque" from the stator to activate it , the moment it switches it drops the torque load causing a back and forth movement until it stabilizes. This will be replaced with an electronic controller and retested. I will post results on this as it progresses.

Here are some other shots of the blades and the completed rotor assembly....



They always look nicer with paint... although the finishing process isn't one of my favorite parts

of the project it has to be done.... I placed 6 inch strips of leading edge tape on each blade. This helps to protect the edge when its spinning fast in the rain. The first few turbines I built didn't have this protection and the blades showed major erosion after about a year or so. Since then I've been using the leading edge tape you can get from ultralight aircraft suppliers with little to no problems with erosion.

I balanced this one a little different than I've done in the past. I usually make a weight plate to bolt on the light side which has worked well in the past. This one, since the blades are small, I weighed each blade on a postal scale and matched all the other blades using small lead weights inset into the wood and epoxied in. Initial run up seems good but I've only had it to 800 rpm so far....that's running in a 12.5 mph wind with no load on it.... we'll see...

Below shows the basic's of the stator mount, spindle and furling system. All the components of the furling system are not mounted in this shot but the basic gravity system is shown. Very similar to an automotive front spindle assembly... ( Look like a volvo?.....not quite, its all hand made - with tools of course). I wouldn't think it would take much to modify an automotive spindle to do the same job. If it can be done, the Dan's at [www.otherpower.com](http://www.otherpower.com) will do it!!!



Below is a shot of the stator installed and the wiring almost completed.



I didn't really design it for all the electronics to fit behind the cover so it became quite a challenge to get everything to fit. This is a star/delta controller powered from the alternator itself to drive the relay. Bench testing proved quite successful. The controller unit was designed and built by Robert Nance Dee at

Design Specialties ( <http://www.dsgnspec.com> ) and its quite unique and great for experimenting with different alternator designs. The controller can be adjusted from 300 rpm to 1050 rpm for switching from star to delta and also a delay before it switches from .5 sec to 7 sec. This allows for the winds to be more constant before actually switching. Without the delay, in certain winds, it would constantly be switching back and forth as the rpm changed.

The unit has since been completed and placed on the tower for some real life tests. Of course as soon as you put up a new unit mother nature has to play games with you and there has been little to no wind for a couple days now. But I did get some interesting results in the lower winds.

The chart below shows the output that I've been able to collect so far....

Calculated	Total	Actual	Efficiency	RPM	Wind	Amps	Tip Speed	TSR
watts	watts	watts	%		Speed			

18	40	0	0	256	9	starts chr	33	3.6
30	85	19	22	317	11.6	1.5	42	3.6
48	107	38	35	385	12.5	3	51	4
72	138	50.8	36	430	13.6	4	57	4.1
96	208	76.2	36	512	15.6	6	68	4.3
113	294	101	35	612	17.5	8	81	4.6
180	668	195	29	823	23	15	108	4.7
300	1799	320	17	1090	32	25	144	4.5

The first thing I noticed that was outstanding from the upwind versions was the slower pivot when adjusting for variations in the wind direction. It seems to correct itself at a very even pace which would lead to less stress on the blades as well as the bearings. The second characteristic that stood out was the the way the rotor speed changed. The rotor actually came out fairly heavy with the steel disc, magnets, blades etc. and it seems to pick up rpm at a steady pace and also when the wind drops off it slows down much more slowly. Like a flywheel absorbing energy and bleeding it off as the power was relieved. The blades were designed to run at a TSR of 4 and I noticed it running below that in lower winds and above the rated mark in the moderate winds. There seems to be more load than the blades are making in power at the lower range but the blades are outperforming the alternator in the upper range. This could be caused by the core saturating to quickly or the ceramic magnets aren't saturating the coils properly as speed increases.... not a good thing.

As I get more information on the unit I will post it... It seems to perform ok but a bit lower than I calculated and expected.....

On the pole and running.....



# Darrieus Type

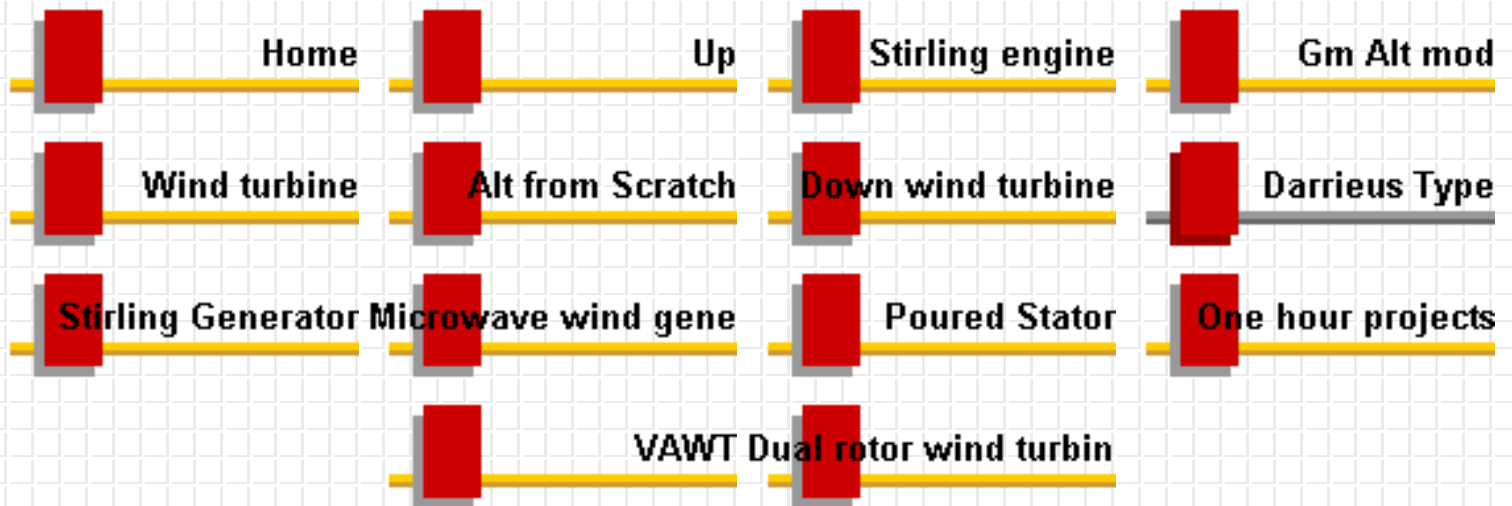

This was a fun wind project and I learned alot about these from researching and building this. This is a Darrieus type wind turbine. Probably more in the cycloturbine class. Most of the Darrieus type turbines don't start themselves and need an external source to start the spin. Actually it should be stated that they don't start themselves reliably because in certain circumstances they will start and run by themselves. This project incorporates a tail driven cam that angles the blades in and out of the wind and probably more of a drag type than lift type and **will** start by itself - reliably. As soon as the tail is pointed to the wind... its running ! The pictures below show the small unit I built as an experiment into the wonders of these fascinating machines...





This unit was approximately 2 ft tall ( blades ) and 2 ft in diameter and would spin around 450 rpm's in a 20 mph wind. I've had several different small pm motors attached to it for testing and the best one was an electric "weed eater" motor which would produce about 50 watts in a 25mph wind. I was quite impressed for its size and materials it was made from. It was up for about a year and had survived a 70 mph storm. I really wish I had a tach on it that day, the only visual on it was the tail and center. It did however suffer a main bushing seizure the very next day.... A little grease and it was back up and running.

The next one soon to come is a 3 ft by 3ft unit with the same tail driven cam design but incorporates lift on the upwind blade.....

Below are some pictures of the new unit.... First two show the mounting and hinges as well as the push/pull rod for the tail driven cam... I made provisions for 2 setting for the wing control rods. The farther out the less movement and the closer in the more movement. Close in there is alot of torque but less rpm and farther out the rpm goes up and the torque goes down.... interesting although I believe the power output is about the same. It runs just a bit faster than the wind and calculated a TSR of about 1.5 to around 3 with the movement lessened.



The next one shows the completed unit on a 6 ft ladder.... and it had a 6 mph breeze at the time so it was difficult timing the shot....



I've taken this unit out in a 12mph wind and as soon as the tail points into the wind its off and running. Doing a performance test using the old "finger dyno" on the shaft I could not stop it from turning... as hard as I was squeezing it simply would not stop... I was impressed... and the dyno was measuring some extreme heat!! I decided not to go any further with this one and a new project springs to life.... A 4 ft dia x 6 ft tall blades... possibly a 3 bladed unit with the cam design...

We'll see.....

# Stirling Generator

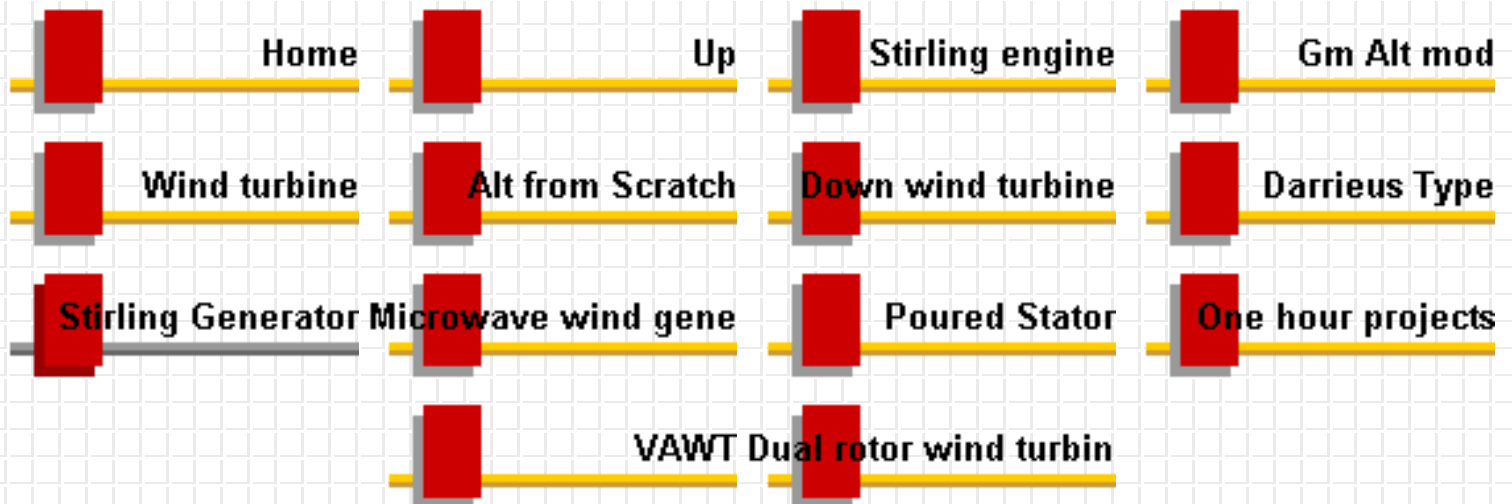

## Stirling engine-generator

This was a fun project, although not finished completely. It has a 1 inch bore and a 3/4" stroke. The flywheel/magnetic rotor is just under 6 inches, stands 14 inches tall and 11 inches wide. Has a hand wound 3 phase alternator with a homemade rectifier. Using a candle as the heat source will make about 4.5 Volts and enough power to light 10 ultrabright LED's or a string of 36 3volt Christmas lights. Using an alcohol burner will produce over 8.5 volts and will power as many as 75 ultrabright LED's. Using a propane torch it will charge a 12 volt battery. The picture shows it running on alcohol ( small homemade burner) making over 8 volts open voltage....



I've charged ni-cad batteries with it while experimenting. It doesn't take a massive amount of heat to run it as it will run on boiling water. About 130 degree difference. It runs fairly smooth up to around 800 rpm and is very quiet. I've had it running at over 1100 rpm but it doesn't really like that. The clearances are pretty close and you can hear the displacer piston making a ticking noise at that speed. Below are other angles of the motor/generator.....

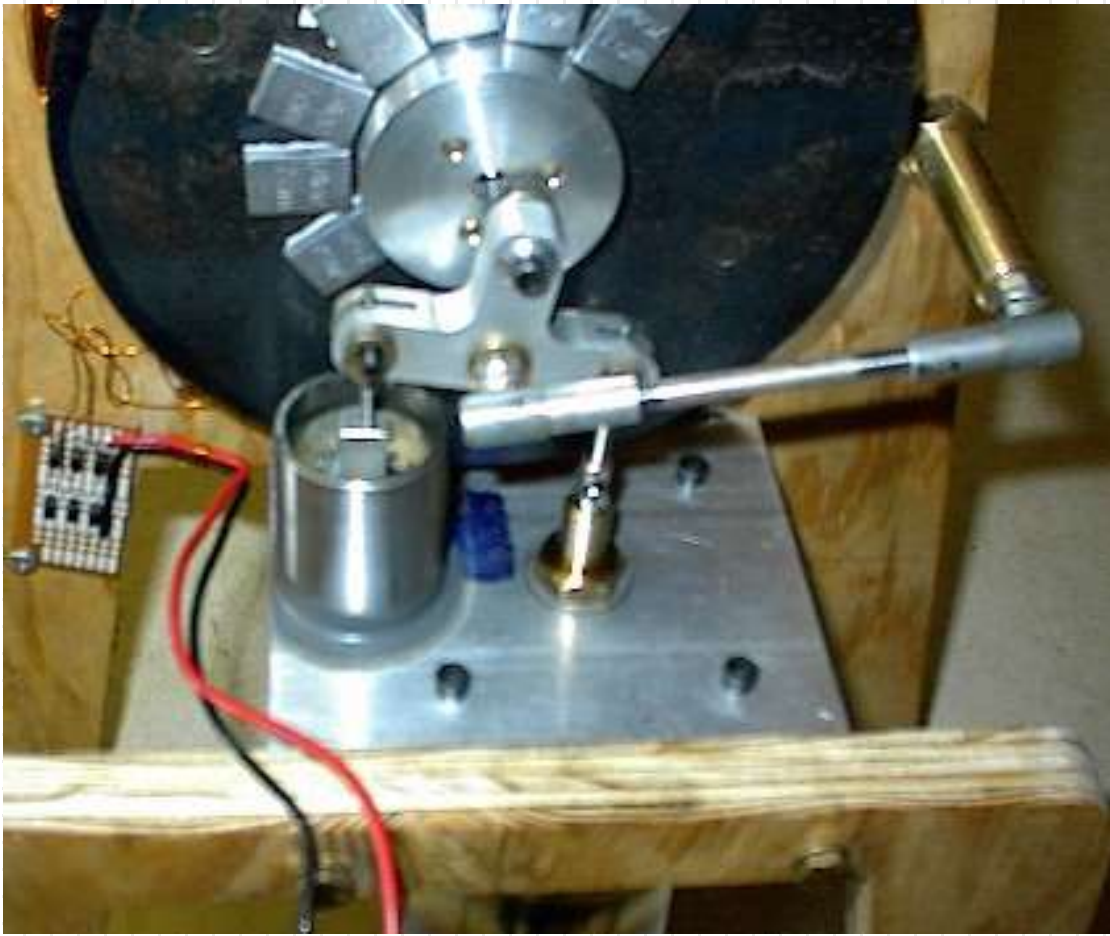

This is a "Ross Yoke" set up where both the displacer piston and power piston share a common crank throw and offsets the two pistons by approx 90 degrees....



Above is the "hot end" made from a stainless steel cup and aluminum housing....



Above is another angle of the stabilizer rod to the yoke....





Opposite side, you can see the lead weights to offset the weight of the pistons for balancing. Not perfect but is fairly close up to about 800 rpm where it will start vibrating a bit..... I'm in the process of building one about the same size dimensionally but with a 2 inch bore and 3/4 inch stroke.... more on that one later....



# Microwave wind generator

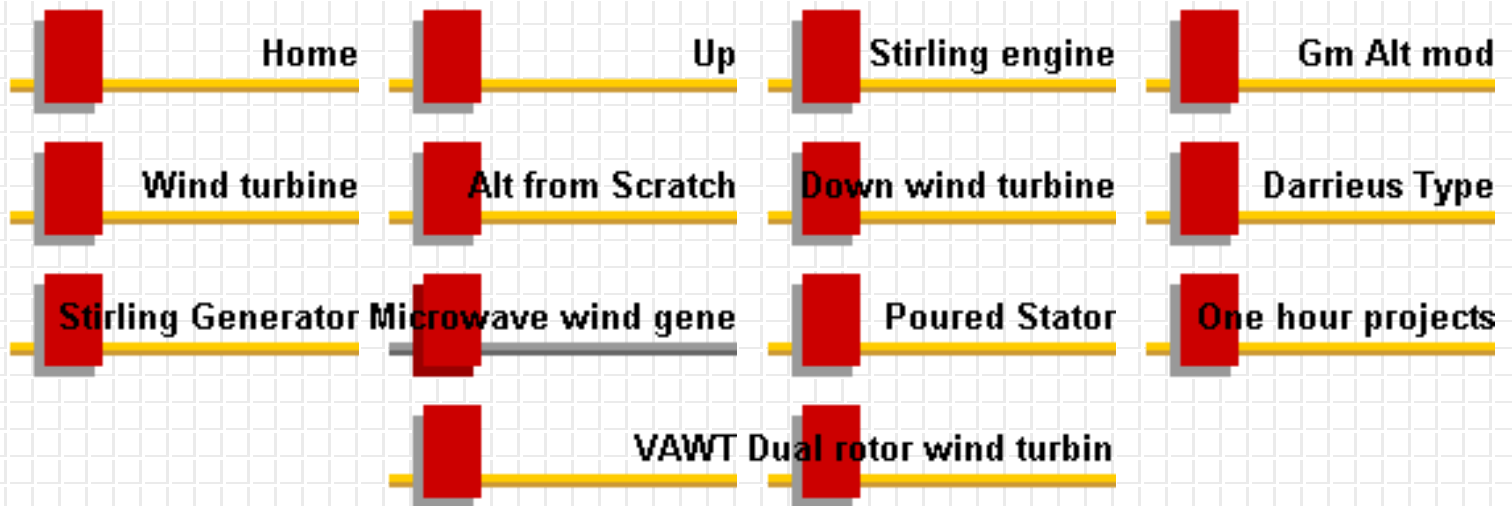

This is a lesson on recycling. Everything here was built from scrap microwave ovens with the exception of the bearings and pivot mount also the plywood. Microwave ovens have an abundant source for the materials used in making an alternator and the rest of the components of an actual working wind generator. They contain large 2 1/4" round magnets ( 2 in each unit - in the magnetron ) plenty of sheet metal ( cases ) and even useful wire in the transformer. You could actually use the transformer metal as the stator laminates.

This will probably dry up my source for microwaves but you can call any appliance repair and find many microwaves free for the asking. I called one shop just to inquire about the possibility of getting a couple, they told me they had a few. I went over there and he directed me to the warehouse where there was about 40 of them. He looked at me, smiled and said if you take one you have to take them all.... I really think he was kidding but 3 trips later they were all in my shop. I tore them down and started saving all the little parts that could prove to be useful for other projects... screws, rubber feet, micro switches, fans, transformers, etc... ( I don't throw nothing away ) and about 80 magnets.

I started out by cutting an 10" disc out of plywood, cut strips of steel out of the case to make the laminates. Coiled the strips to form the stator and epoxied them to the board. I used strapping tape on all the metal strips which served two purposes, One to help hold the whole thing together and Two to isolate them from each other thus reducing eddy currents. I machined 24 slots to hold the wire and started the winding process.

Below are the beginning shots of the process...



There is 60 feet of 3/4" steel in this stator. The stator is 8" in diameter and 2" wide. Below show the winding in process...



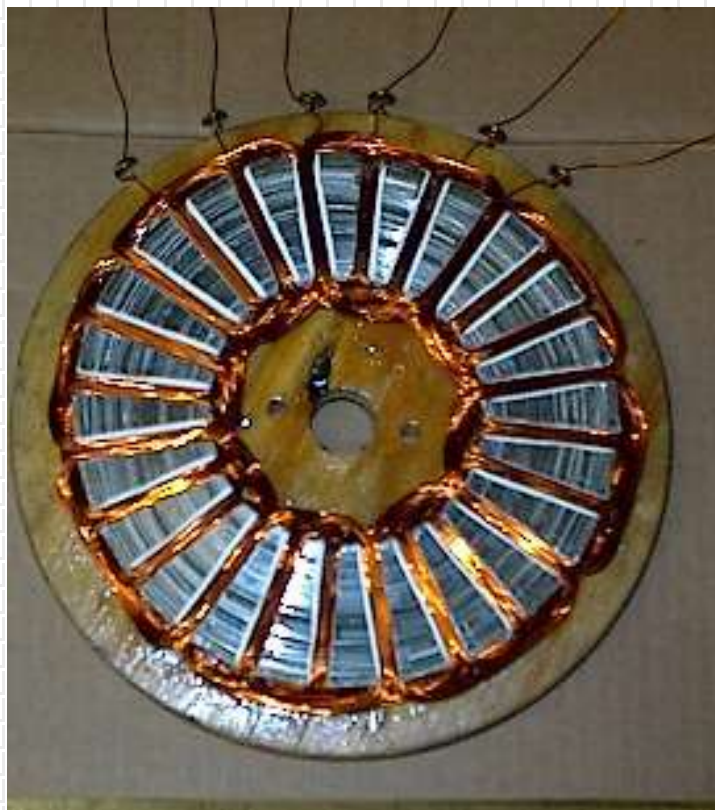

The white inserts are made out of old milk cartons to isolate the wires from the steel. Each picture shows each of the 3 phases being placed into the slots. This was wound on the stator itself and each phase is wound as if it were a single phase unit. There are 36 wires in each slot making up 18 turns per coil. And yes I know I blew my rule number one... Keep it

simple. The slots really are unnecessary but do help to bring the power and efficiency up and since this is a small turbine ( 28" diameter) I needed all the efficiency I could get.

Initial testing of the alternator came out quite promising. At 600 rpm the open voltage was 29.6 volts. My goal here is to make a very small turbine that will produce 150 watts in a 30 mph wind. After many doodles and calculations, 3 or 4 pads of paper later this is what I've come up with. I'm not going to show the turbine in great detail and all the alternator functions will be left out as there is a patent pending on this unit, although won't be manufactured out of microwave ovens in the end.

Below is the preliminary installation of the stator on the pivot head of the turbine. You can see the coils are shrouded and sealed...



This next picture shows the microwave magnets taken from the "magnetron" and setting on an 8" steel disc. Also shows the octagon plywood rotor ( 14" ) and the blades mounted on the rotor assembly. Using steel blades makes the rotor quite heavy and would be extremely susceptible to high winds and over speeding. This is simply a test unit and will not be installed permanently...

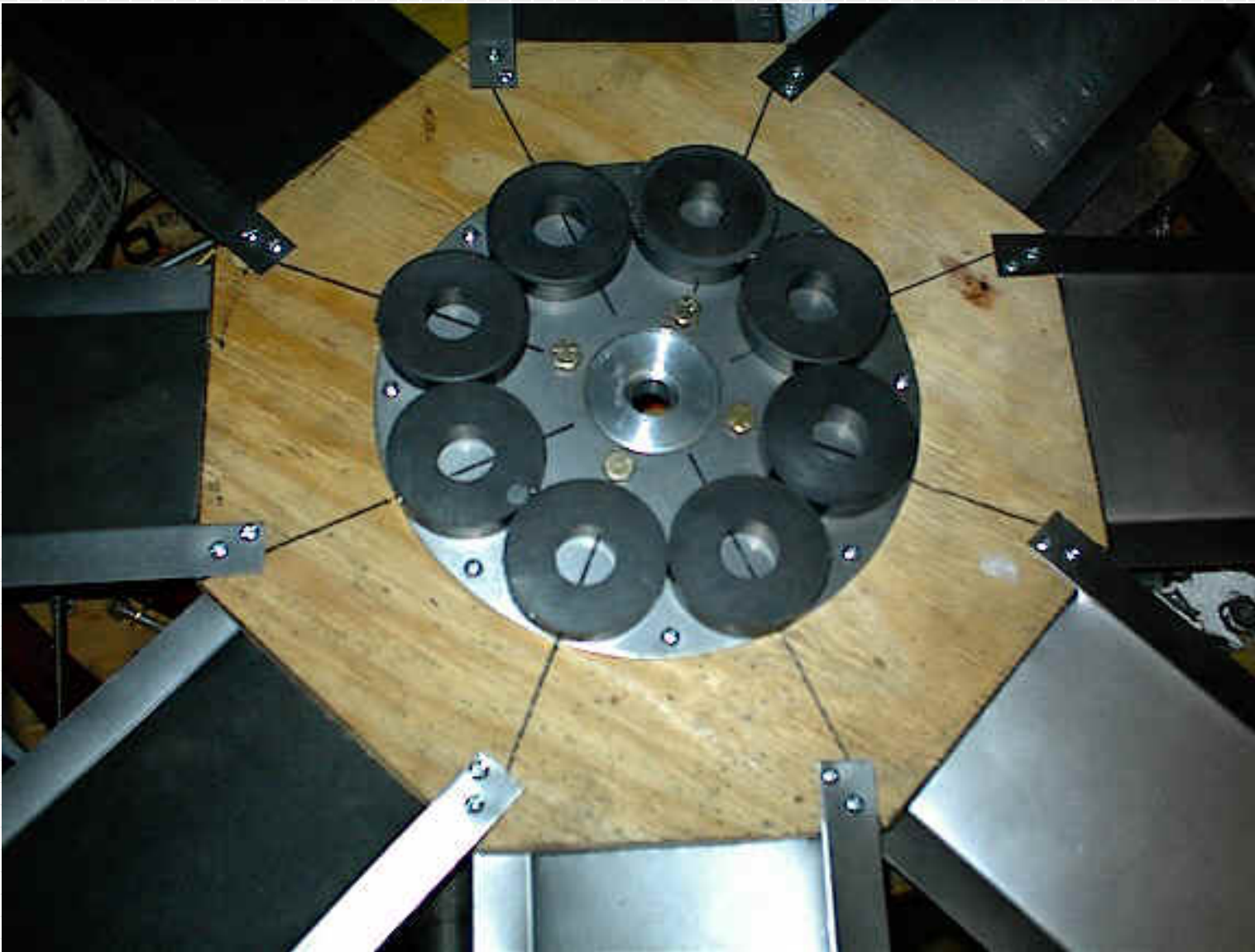

I've calculated the stress point to be somewhere around 1100 to 1200 rpm before the wood structure would come apart, this being winds at around 50mph. This could be changed by adding longer mounting tabs on the blades and installing 3/16" bolts instead of the sheet screws. The blades are 7" tall and 8 of them are installed on the plywood. Each blade is set at an angle of 10 degrees. The metal came from a large microwave case and was bead blasted and is now ready for paint. The plywood will be coated in poly resin ( fiberglass resin ) to seal and waterproof the assembly, the magnets will be resin'd in also.

After all was assembled, unfinished and semi balanced, testing went fairly well. The performance of the "microwave" turbine was below my projected output but not bad for its size. The maximum output achieved was 90 watts in a 30mph wind. It performed well in lower winds giving 22 watts in a 14mph wind. No powerhouse by any means but for its size ( 28" - not much bigger than a basic box fan) it did quite well.

All in all a good lesson in scavenging and making due with what is available. The entire project cost about 8 bucks not including any labor. Comes out to about 8 cents a watt....

I've dismantled this unit since and have added a different rotor with 6 blades. Initial tests on the new one are providing much better results but still about 20watts under my goal here. Initial testing showed an overall efficiency of 23%. The eight bladed ( steel blade) was giving me about 11% ( not impressive by any means). I'll post some images of the new rotor shortly.....

The blades are carved from standard 2x4 board scraps and the center was brought down from the 14" octagon to a 10 circle allowing for more blade area....

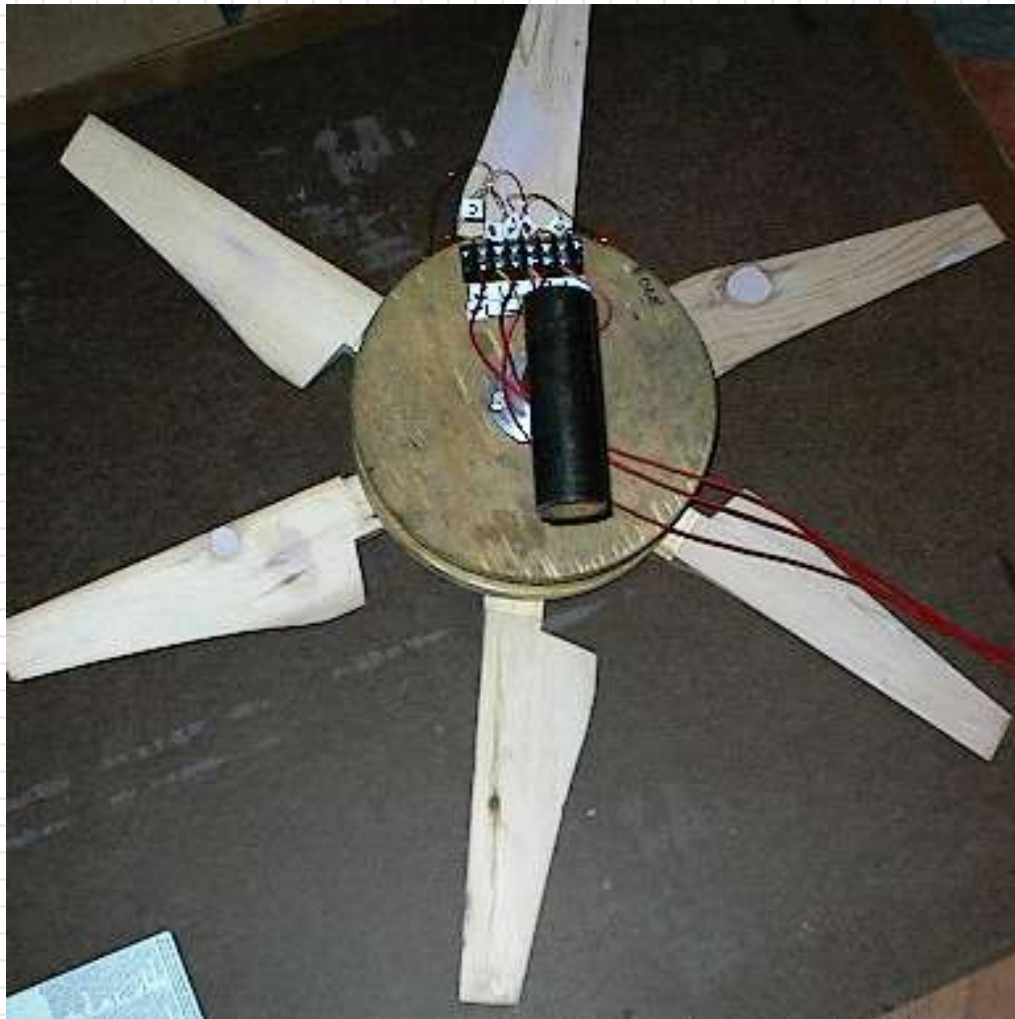

Still only 30" in diameter, testing was done in a 14 mph wind and the results are coming out good. Unloaded the blades run around 720 rpm and with a load 570 rpm. Using a slightly dead battery with a 50 watt load its making 11.75 volts at 1.7 amps ( total of 19.9 watts ). The total available watts for that area of blade is 77.78 so that makes the overall efficiency of around 25%. It will make about 170 watts in a 30mph wind and the efficiency drops to around 22%. Still just over 13 amps at 12.7 volts... not bad for a tiny turbine...

Still testing various configurations and shields.....





# Poured Stator

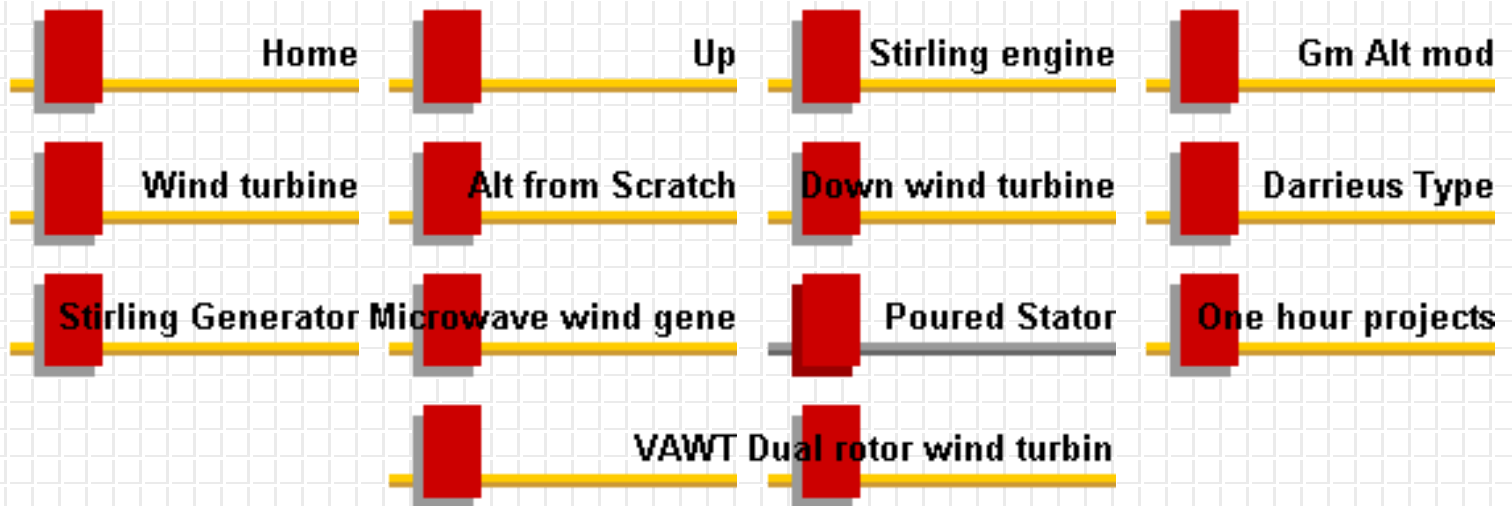

This is the beginning test of a full size poured stator. I've done some small ones in the past for stirling engine projects but never really followed up on them. Bob Gayle inspired me to follow up on it to see if would really perform equally as well as a steel slotted stator. Initial tests are showing some losses over the steel core but with the ease of fabricating it may well be worth the efficiency loss over labor involved with the steel slotted cores. Here is a picture of the poured core stator ....



To keep it simple I used fiberglass resin as the binder and mixed in the iron powder. It was basically a paste when mixed. There is about 5 pounds of iron powder in this stator. Actually, very little resin was needed to saturate all the particles, guessing at around 6 oz. The slots are .46 deep and .3 wide for 14 turns of #15 wire through 36 slots. There will be 12 magnets used on this one. I plan to test the unit with both ceramic 5 magnets and neodymium type. Ceramics are nice in the sense there is little to no cogging effect but I don't expect the cogging of the neo's will be bad enough to hurt performance much.

Below is a picture of the stator completed with all its windings....



The next one shows the stator just as it was being finished with the 3rd phase. Notice the special clamp for getting the last phase in place. Typically the last phase goes in sort of free hand, but, because of the wire size used in this one this is near impossible. The clamp holds snug to the stator core and allows you to wind the wire without having to use all 12 fingers on each hand



The initial tests proved that this unit would work but at less efficiency than the steel strips. I suppose the efficiency loss is a fair trade off for labor. The unit has 12 poles using the 1.5" round neo's. 12 turns per coil and 12 coils per phase ( 36 coils total ), Each phase came in at .3 ohms. #15 wire was used for some fair power. Because of the low turns of wire the rpm per volt came in fairly high which would require a fairly good size prop to drive it. An 8 ft prop designed to run at around a TSR of 8 would work quite nicely making around 650 watts of power in a 28mph wind. Not to bad for a small 8 inch unit.

I plan to do some brief testing with some ceramic magnets cut from the large rings I sell in the "builders corner" of this site under products. I'm sure it won't be a potent as the neo's but something I have to give a shot. This will increase the magnet area considerably so the loss shouldn't be drastic.....

Stay tuned

# One hour projects

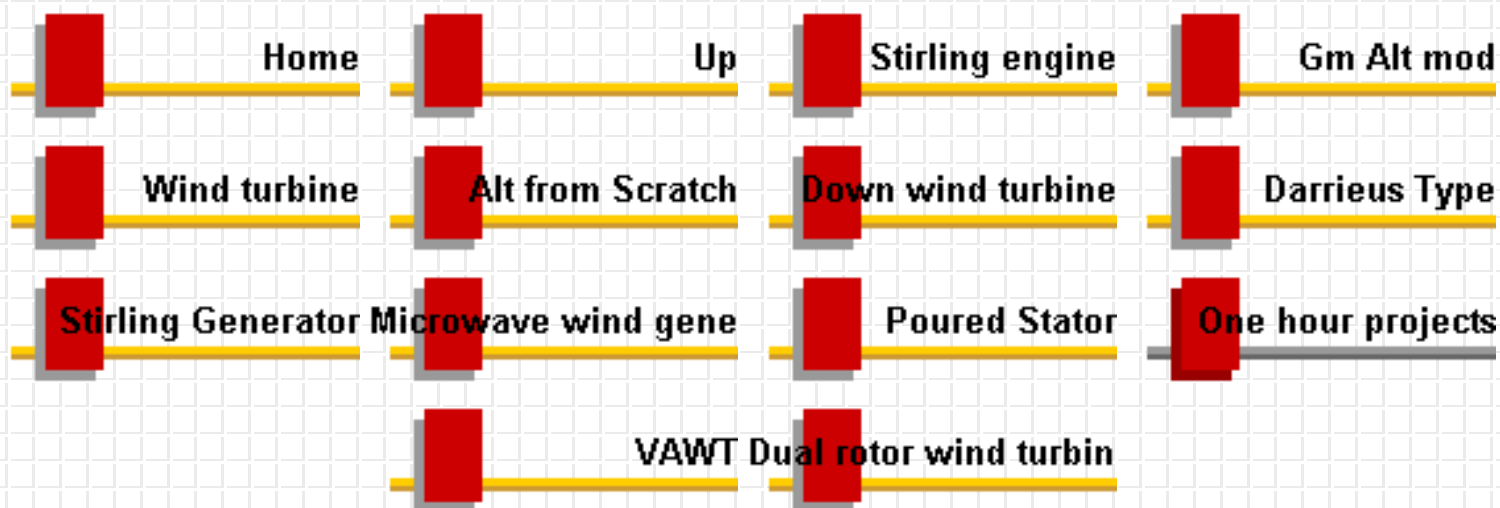

These are projects that basically can be done in about an hour depending on your skill level. Most of what is here can be done with basic hand tools. The first of this series is going to be the wind turbine blade sets. As shown below the frame structure is very basic and is covered in poly fabric used in aircraft construction. The actual name for this procedure is "stits" covering. The fabric is glued into place on the frame work then simply shrunk to fit and it gets extremely tight when completed.



The above blade was built in under 20 minutes using the "tube and wire" method. That's from cutting materials to the blue assembly. It will still need paint but all 3 blades can be built in about an hour. The blade will follow a twist from 2 degrees at the tip down to 23

degrees at the tip. Its set to run at a TSR of around 6 and is a total of 5ft in diameter. Other sets can be made of any length up to around 12 feet using this method and properly calculated components for stress loading. These will withstand winds in excess of 70 mph.

more later

Another quick project for experimenting or fun for the kids to experiment with... These are flat plate turbines. Related to the Savinous but with less detail and considerably easier to build.

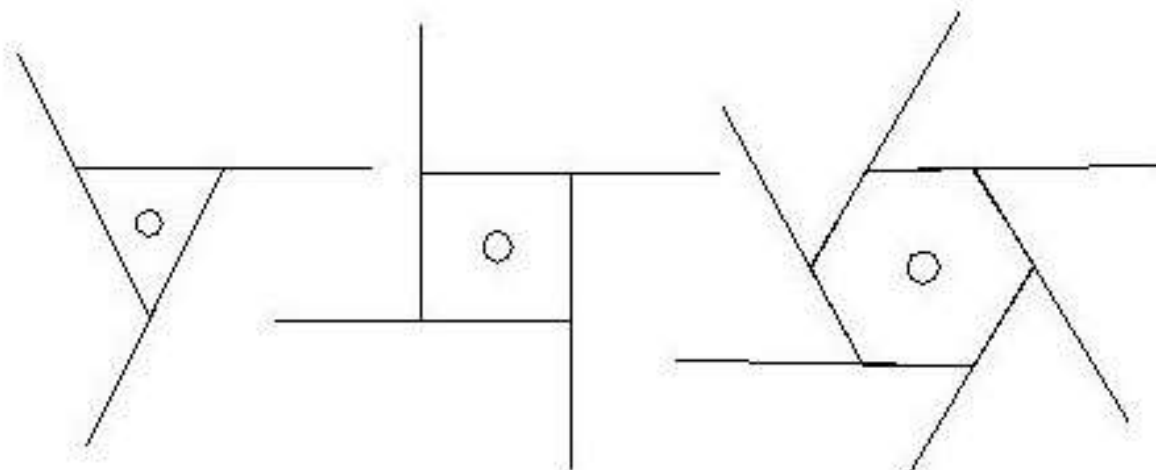

**3 variations of the "flat plate windmills"**

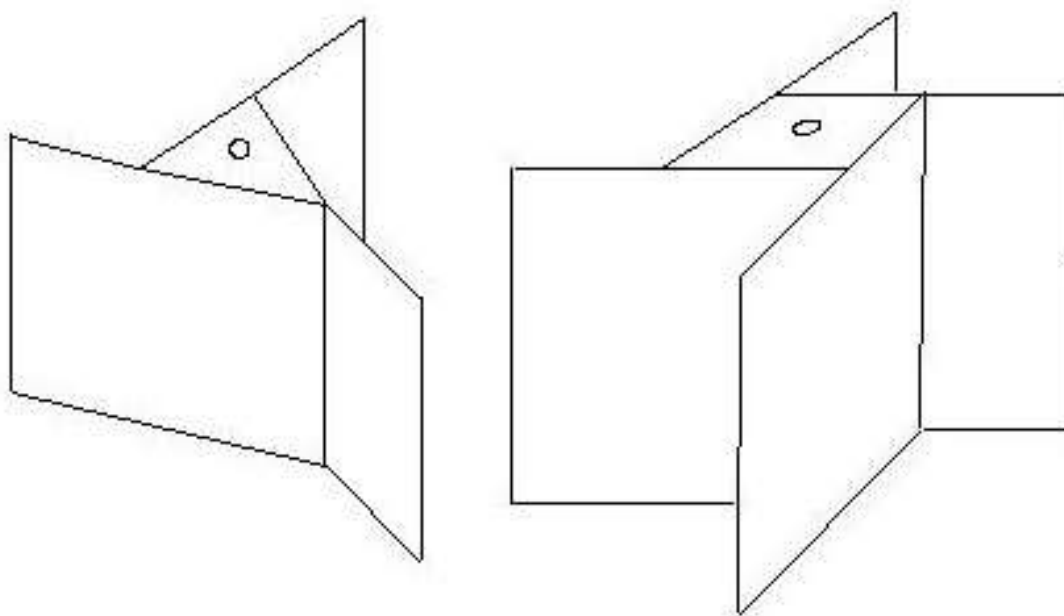

As you can see from the above diagrams, there is basically nothing to them. Their power output is fairly low similar to the Savinous but do a very nice job. They will spin in winds you

can hardly feel. Below is a picture of one I built from Lexan and plywood. Its quite small and does no real work but spins all the time.... fun to watch... It would be quite simple to add a small low voltage alternator and power some LED's for driveway lights or what ever. I plan to experiment with that in mind...



The picture is a bit difficult to make out and when its spinning fast is almost invisible.

# Turbine kit

Home

Up

Turbine kit

Builders Corner

3Phase turbine kit

## ***Basic Wind turbine Kit...***

***This kit is no longer available. I have left the page in for reference to how it works and what it looks like.***





Don't quite understand how it works? Read below.....

**This is a self furling unit. The furling system is based on mother natures best kept secret - gravity. When the wind reaches a certain speed, the unit self furls based on the tail weight.**

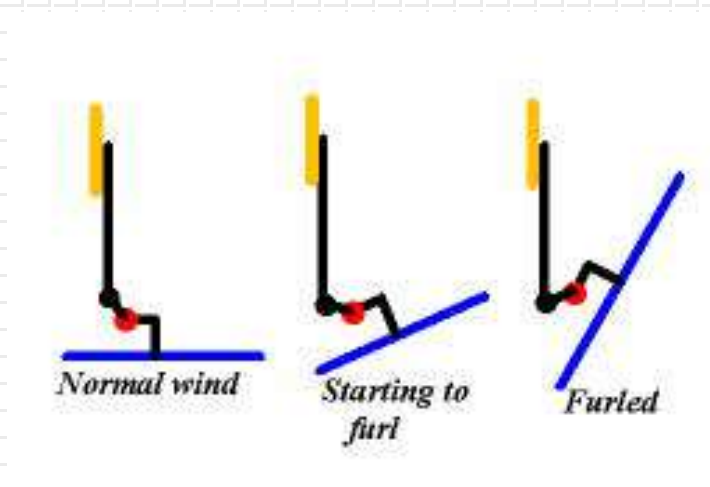

The way this works... The head pivot point and rotor shaft center are offset. The extent of the offset is determined by the diameter of the rotor. When the wind exerts itself against the rotor ( Rotor Thrust ) it wants to turn because of the offset head. The angle of the tail mount and weight of the tail determine the amount of resistance there is to this turning. The system is very similar to the "caster" angle used in automobiles, when you turn the wheel to the left or right, one side tends to lift the car. When you let go of the steering wheel the weight of the car tries to bring the wheels straight again. This is the same basics this wind turbine uses. The angles and weight are calculated to adjust the furling to any windspeed.

The Rotor thrust can be calculated by using the following formula.

$$\text{Rotor Thrust} = \text{Diameter}^2 * \text{Velocity}^2 / 24$$

Rotor thrust is in kg - to convert to lbs multiply kg by 2.2

To Calculate the tail weight or to find the tail mount angle... we need to know...

Rotor Offset ( meters )

Diameter of Rotor ( meters )

Wind Speed ( meters/second )

Tail tip weight ( kg )

Length of tail ( meters )

Then we need to calculate....

$$\text{Rotor Thrust} = \text{Dia of Rotor}^2 * \text{Windspeed}^2 / 24$$

$$\text{Tail moment} = \text{Tail tip weight} * \text{Length of tail}$$

$$\text{Rotor moment} = \text{Rotor Thrust} * \text{Rotor offset}$$

$$\text{Tail mount Angle} = \sin^{-1}(\text{Rotor moment} / \text{Tail moment})$$

If you need to find the Tail tip weight at a given tailmount angle then...

$$\text{Tail moment} = \text{Rotor moment} / (\sin(\text{Angle in degrees}))$$

$$\text{Tail Weight} = \text{Tail moment} / \text{Length of tail}$$

# Generator

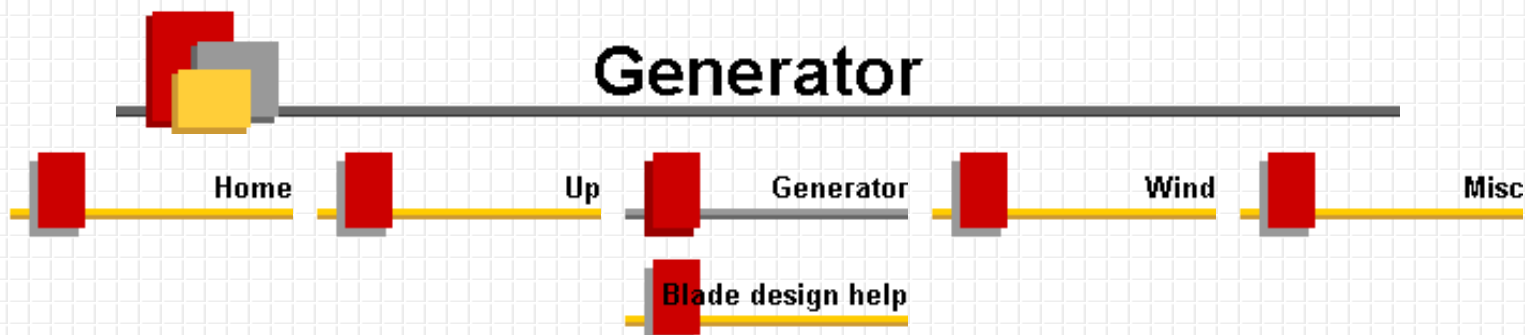

## ***Handy Formula to calculate the output of any generator at any given RPM.....***

*First off 3 things must be known... RPM, Open voltage at that RPM and the Ohm's of the stator coil.*

1. *Measure the RPM*
2. *Measure the Open voltage at that RPM*
3. *Measure the Ohm's of the stator coil.*

**Measured RPM / Open volts = RPM per volt**

*To find a Desired output the formula is:*

**Volts + ( Amps \* Ohms ) = Open Voltage ( necessary to achieve this output )**

**Open voltage \* RPM per volt = RPM needed to achieve desired output**

*Example: Alternator spinning at 1500 RPM delivers an open voltage of 34.8 volts so....*

**1500 / 34.8 = 43.1 RPM per volt**

**The stator coil reading is .6 ohm**

**Lets say we would like 14.6 volts at 10 amps from our unit**

$$14.6 \text{ volts} + (10 \text{ amps} * .6 \text{ ohm}) = 20.6 \text{ open voltage}$$

$$20.6 * 43 \text{ rpm per volt} = 885.8 \text{ RPM}$$

*If you would like to know an output at a certain RPM you simply change the formula to:*

$$\text{RPM} / \text{RPM per volt} = \text{Open Voltage}$$

$$(\text{Open Voltage} - \text{desired voltage}) / \text{ohms} = \text{Amps}$$

**Example: 885 RPM at 14.6 volts**

$$885 / 43 = 20.58$$

$$(20.58 - 14.6) / .6 = 9.97 \text{ amps}$$

*And there you have it... since, for the most part, the voltage and rpm are a constant its easy to calculate the output of any unit*

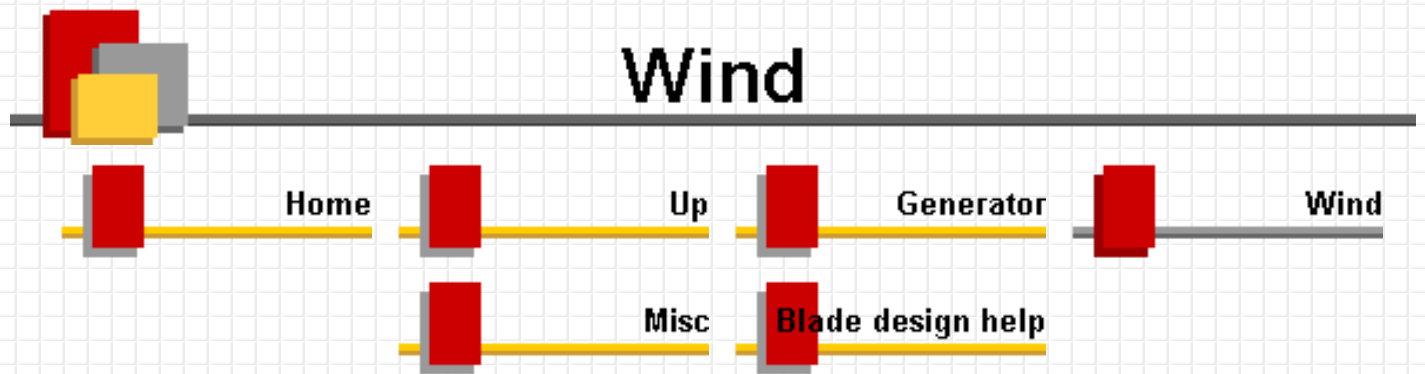

## Wind Charts How much power is in the wind?

$$P = .5 * AD * (D^2*.7854) * V^3$$

Where: P = power in watts

AD = air density ( typically 1.22 at sea level )

D = Diameter of prop ( in meters )

V = Velocity of the wind ( in meters/sec )

So we could say in a 20mph (8.9 m/s) wind and a 6 ft dia ( 1.8 m) prop there is ...

$$P = .5 * 1.22 * (1.8^2*.7854) * 8.9^3 \text{ or}$$

**P= 1094** watts passing through the prop

Unfortunately we cant capture all of it and most blades range in the 20% to 40% range so we need to add this into our formula...

$$P = .5 * 1.22 * (1.8^2*.7854) * 8.9^3 * .4$$

**P = 437** watts coming out of our blade at the shaft.

Now there are some other losses we have to deal with... The generator or alternator we are using isn't 100% efficient so we need to add this into the formula. We can say that our blades are 40% efficient and our generator is 60% efficient so... Our overall efficiency would be ( .4 \* .6 = .24 ) 24%. So now we add that into the total and we get...

$$P = .5 * 1.22 * (1.8^2*.7854) * 8.9^3 * .24$$

**P = 262** watts

This is the majority of the losses but there are others that we won't worry to much about

at this point. The formulas above will give you a close general idea of what your machine might produce.

-----

Here are a few formula's from Hugh Piggott's book "Wind Power workshop". He has allowed me to put them up on my site via email. Again I strongly recomend his books for anyone getting into wind power.

If you know what your alternator/generator will do in watts, this one will help determine the size prop you will need to run it....

$$D = (P / (Cp * rho / 2 * Pi / 4 * V^3)) ^ 0.5$$

Where D = Diameter of prop in meters

P = power in watts

Cp = overall efficiency ( typically .15 to .20)

rho = air density ( 1.22 at sea level )

V = velocity of the wind in meters/second

If you have a prop you plan to use, this one will determine the power output you can expect...

$$P = Cp * rho / 2 * Pi / 4 * D^2 * V^3$$

To find the TSR ( tip speed ratio ) of a prop at a given output...

$$TSR = rpm * Pi * D / 60 / V$$

example: say you find a generator that can produce 500 watts at 1000 rpm...

$$TSR = 1000 * 3.14 * 2 / 60 / 10$$

$$TSR = 10.46$$

Since 10.5 would be fairly tricky to obtain we can try others. To calculate the rpm at a given TSR...

$$rpm = 60 * V * tsr / ( Pi * D )$$

example: with a tsr = 6 we would get...

$$\text{rpm} = 60 * 10 * 6 / (\text{Pi} * 2)$$

$$\text{rpm} = 573 \text{ rpm}$$





# Misc

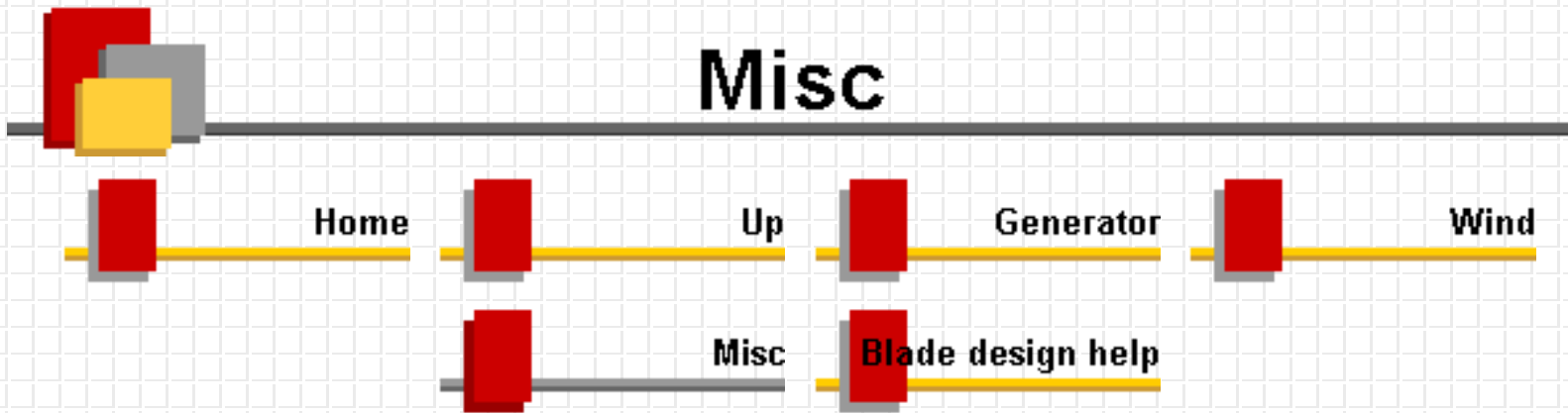

## Horsepower and torque:

$$\text{HP} = \text{Torque} \times \text{Rpm} / 5252$$

$$\text{example: } 2\text{hp} = 35 \text{ ftlbs} \times 300 \text{ rpm} / 5252$$

$$\text{Torque} = \text{HP} / (\text{Rpm}/5252)$$

$$\text{example: } 2\text{hp} / (300 \text{ rpm} / 5252) = 35 \text{ ftlbs}$$

$$\text{Rpm} = \text{HP} / (\text{Torque}/5252)$$

$$\text{example: } 2\text{hp} / (35 / 5252) = 300 \text{ rpm}$$

---

$$\text{Power} = \text{Work} / \text{Time}$$

$$\text{Work} = \text{Force} * \text{Distance}$$

$$\text{Power} = \text{Force} * \text{Distance} / \text{time}$$

---

## BTU ( British Thermal Units)

BTU is the rate of bringing 1 lb of water up 1 degree.

BTU = pounds of water \* difference in temperature rise

1 cubic foot of water = 64.2 lbs

So to bring 1 cubic foot of water from 50 degrees to 100 degrees ( 50 degree difference )

$$\text{BTU} = 64.2 \text{ lbs ( 1 cubic foot ) } * 50 \text{ degrees}$$

$$\text{BTU} = 3210$$

1 cubic foot of water = 7.48 gallons ( or 8.58 lbs per gallon )

Say you have a gallon of water (8.58 lbs) and its at 60 degrees, you want to bring it up to 110 degrees. You will need a 50 degree rise in temperature

$$\text{BTU} = 8.5 * 50 = 425 \text{ Btu}$$

$$\text{Watts} = 425 \text{ Btu} / 3.41 = 125 \text{ watts}$$

So at 125 volts you would need one amp for one hour to bring the water to the desired temperature.

---

Centrifugal Force:

$$.000341 * W * R * n^2$$

Where: W = weight of outer ring

R = Radius in feet

n = RPM

---

Kinetic energy:

$$E = ( W * V^2 ) / ( 2 * g )$$

**Where E = total energy in flywheel, in ft lbs**

**W = weight of flywheel**

**V = velocity in feet per second of outer radius**

**g = acceleration due to gravity ( 32.16 )**

# Blade design help

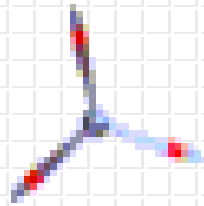

The Blade Designer Program - A Free Basic Help Tutorial in Blade Design

**Blade designer**

Rotor diameter (meters)

Tip Speed Ratio

Number of Blades

Angle of attack (deg)

Lift coefficient

Number of stations

Overall efficiency

Station	Radius (in)	Blid ang (deg)	Chord (in)	Thickne (in)	Drop (in)
1	12.	19	9.32	1.4	3.58
2	24.	8	5.24	.79	1.07
3	36.	4	3.58	.54	.49
4	48.	2	2.71	.41	.28
5	60.	1	2.17	.33	.18
6					
7					
8					
9					
10					

**Estimated Prop performance**

	Watts	RPM
10 mph 4.4ms	60	224
12 mph 5.2ms	103	269
14 mph 6.2ms	164	314
16 mph 7.1ms	244	359
18 mph 8.0ms	348	404
20 mph 8.9ms	477	448
22 mph 10ms	635	493
24 mph 10.7ms	824	538
26 mph 11.6ms	1048	583
28 mph 12.5ms	1309	628

**Calculated Generator performance**

	Amps	Open V	Rpm	Ratio	Watts at Rec Ratio
	4.05	17.23	666	2.97	83
	6.96	18.98	734	2.73	173
	11.08	21.45	829	2.64	263
	16.49	24.69	955	2.66	353
	23.51	28.91	1118	2.77	443
	32.23	34.14	1320	2.95	531
	42.91	40.54	1567	3.18	621
	55.68	48.21	1864	3.46	711
	70.81	57.29	2215	3.8	801
	88.45	67.87	2624	4.18	891

INPUT: wind velocity in m/s to calculate rotor thrust

Rotor thrust in pounds

Rotor offset in inches

Tail Size in square feet

Recommended Ratio

User Ratio

Open Voltage

Measured Rpm

Measured Ohms

Regulated Voltage

The inexpensive "blade designer program" is available for purchase from <http://www.windstuffnow.com>

The Blade Designer program was written by Ed Lenz.

This basic tutorial is written by Fred Tonch on May 28 2003 from <http://www.internetfred.com>

 **Table of contents:**

1. introduction
2. hints
3. the program input parameters
4. adjusting the ratios (added features)
5. all adjustments and effects list
6. estimated propeller performance and calculated generator performance
7. using the tables to produce a propeller (optimizing the design)
8. blade terminology
9. building with the design and building the blade
10. credits



About a year and a half ago, I began the daunting task of wanting to create a wind turbine for the sole purpose of producing power. I quickly found out this year that a basic understanding of aerodynamics is a requirement if your intention like mine, is to build and design such a device. Without the proper propeller matched to the generator, the power achieved will be substantially lower than with a matched propeller. The generator and propeller go hand in hand.

I am writing this basic help tutorial from the standpoint of a beginner wind turbine builder. I also suggest purchasing "Windpower Workshop" from Hugh Piggott also available from windstuffnow, as it has the basic essentials and guidelines necessary to building a wind turbine. The book has fairly extensive information regarding blade design and parameters required in design of a turbine. Only the basics will be covered in this help document.

The blade designer program has many added features which are not apparent at first glance. **Armed with the book and this program, basically any small wind turbine and blade can be designed, built and matched to produce maximum output.**

For all types of metric and standard number conversions, use the free program available for download called "[win-convert express](#)". This is a simple zip file. Note: if you are using win95/98 then you must download visual basic 6 runtime if you do not have it installed already or the converter will not work. This program is called VBRun60.exe. Do a search on [www.google.com](http://www.google.com) to find it.



In this help document I use the words "blade" to mean a single blade and the "propeller" a unit

composed of individual blades and a hub connected together as a single unit. Making blades into a propeller is a replication process. Many blades can be produced at once with this program and assembled into a propeller. Also note that some people call the propeller a rotor. Actually the a rotor is a part of the generator, hub housing and spindle assembly, but anything that rotates can be considered a rotor so it's ok to use the term rotor in use of propeller or it's short form "prop".

In the program the highlighted areas marked in a darker gray color are for inputting parameter variables or values used to design a blade. A calculated value located in a table is not changeable except by the adjustment menus. All adjustments and effects where found by adjusting with each input and watching the result or effect. It is highly suggested that you do this also, since it will tell you how the program functions and calculates.

The web site <http://www.windmission.dk/workshop/BasicBladeDesign/bladedesign.html> also offers a very good tutorial on blade design and number crunching.



## The Program Input Parameters

<b>Rotor diameter (meters)</b>	3.048
<b>Tip Speed Ratio</b>	8
<b>Number of Blades</b>	3
<b>Angle of attack (deg)</b>	4
<b>Lift coefficient</b>	.8
<b>Number of stations</b>	5
<b>Overall efficiency</b>	.15

This is the basic area for inputting parameters to create the blade. This is the first menu that will be discussed into it's simpler parts below.

- **Rotor diameter** in meters - the total diameter of the propeller. Here are some standard numbers. To find rotor size in meters you can convert ft to meters by multiplying ft x .3048
- The Diameter is two times the distance from the center of the hub to the tip of the blade. It also can be looked at as the distance across the circle that the propeller would make when rotating. This is also know as the total swept area.

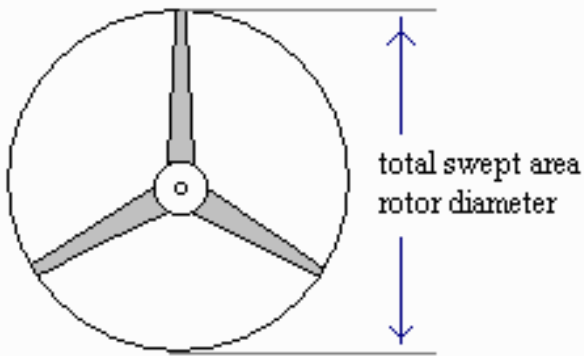

### Standard Meters to Feet

.04 m = 0.131 ft

.08 m = 0.262 ft

.5 m = 1.46 ft

1 m = 3.28 ft

1.5 m = 4.92 ft

2 m = 6.56 ft

2.5 m = 8.20 ft

3 m = 9.843 ft

3.5 m = 11.48 ft

4 m = 13.12 ft

4.5 m = 14.76 ft

5 m = 16.40 ft

- **Tip Speed Ratio (tsr)**- How many times faster than the wind speed, the blade tip is designed to run. The tip of a blade can travel faster than the wind. The tip speed "ratio" is the optimum between stall and runaway. Typical tip speed ratios are 1 thru 10. Tip Speed Ratio (tsr) = (tip speed of blade) / (wind speed).
- **Notes:** Rotors are designed to run best at a particular 'tip speed ratio', but in reality they run at a speed which also depends how they are loaded. If the generator draws more power than the rotor has to offer then it slows, and often stalls.

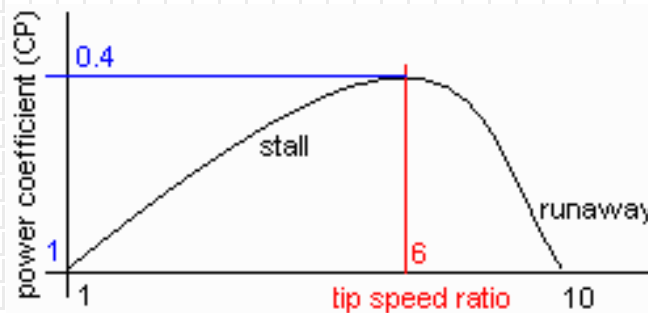



- **Number of blades**- 3 blades is most preferred and most often used. 2 blades produces noise, rattle, imbalance, harder to start in low winds and other problems (tsr>4). (check out <http://www.windmission.dk> for multi bladed designs (tsr<2) at lower wind speeds)



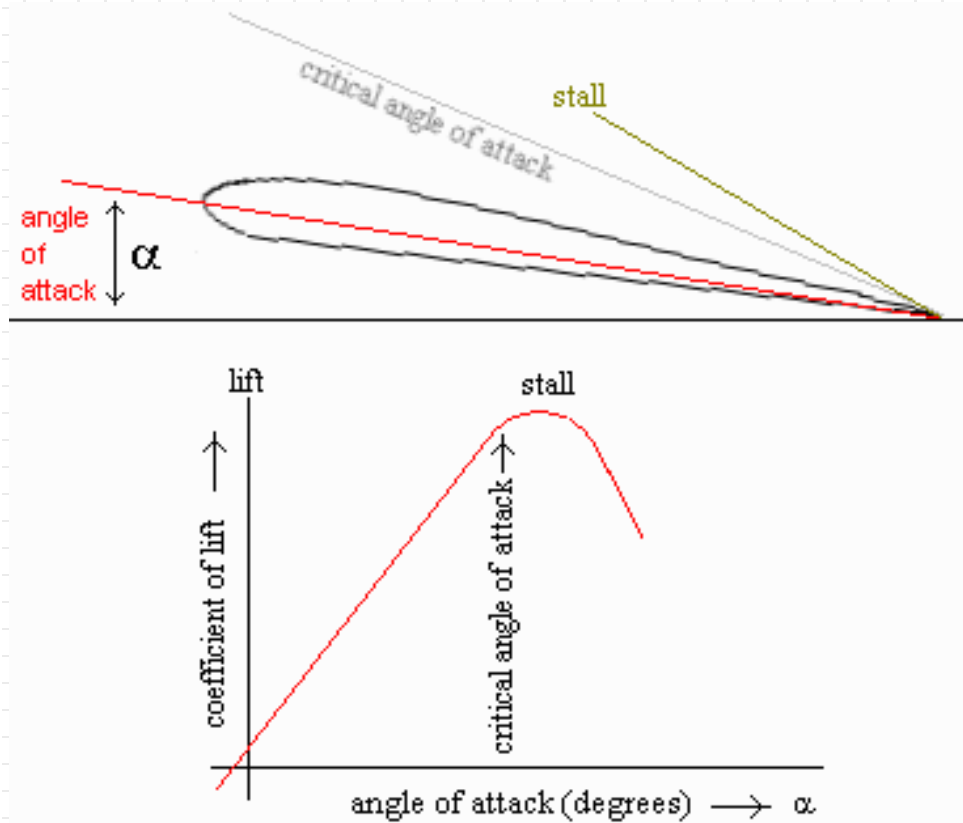

**Angle of attack.**- in degrees. This is the propeller efficiency. 4 degrees is standard. Numbers here can range from 1 deg to 15 deg typical. The angle between the chord line of the airfoil and the flight direction is called the angle of attack. Angle of attack has a large effect on the lift generated by an airfoil.



- 
**Lift Coefficient** - the lift coefficient is approximately two times pi (3.14159) times the angle of attack expressed in radians. Standard setting  $\approx .8$  Typical numbers range from .8 to 1.25
- 
**Number of stations** - This is used to create the blade on a piece of wood. The stations are markings spaced at intervals.

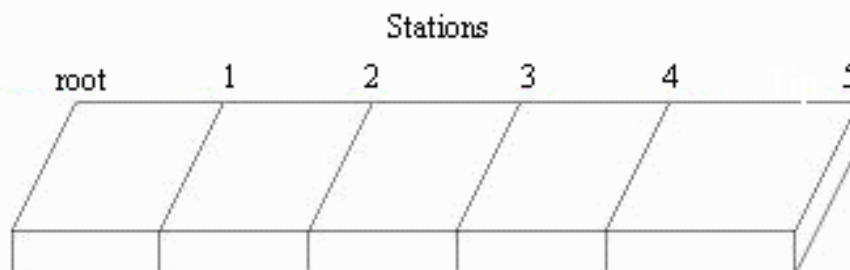

Mechanical losses in the propeller, hub and spindle and electrical and magnetic losses such as usage of iron and wire resistance in the generator effect overall efficiency. All of this is calculated and included in the overall efficiency of the generator.

Typically on a propeller type it ranges from 25-35% overall and on Savinous type about 15%. So if you have a prop making say 45% efficient use converting wind into power and an alternator that is 75% efficient then the over all efficiency would be about 33% ( $.45 \times .75 = .3375$ ). This doesn't include any transmission line losses though.

-  **Overall Efficiency** - Overall efficiency is basically the power you will get out of the generator.



## Adjusting the ratio's (added features)



Calculated Generator performance				
Amps	Open V	Rpm	Ratio	Watts at Rec Ratio
4.05	17.23	666	2.97	83

Adjusting the above calculated values for generator performance.

<input checked="" type="radio"/> Recommended Ratio	<input type="text" value="3.134"/>
<input type="radio"/> User Ratio	<input type="text" value="1"/>
<b>Open Voltage</b>	<input type="text" value="38.8"/>
<b>Measured Rpm</b>	<input type="text" value="1500"/>
<b>Measured Ohms</b>	<input type="text" value=".6"/>
<b>Regulated Voltage</b>	<input type="text" value="14.8"/>

This menu is for adjusting the calculated generator performance values.



-  The Recommended Ratio - This number is a calculated value ratio of all factors of wind speed.
-  The User Ratio - This number is an input option, the user ratio is used to adjust the "Watts at recorded ratio"
-  The Open Voltage is the open voltage from either a "to be built" or "already built" generator

-  The Ohms is the total ohms from either a "to be built" or "already built" generator
-  The Regulated Voltage measured in DC is the voltage from either a "to be built" or "already built" generator

<b>INPUT: wind velocity in m/s to calculate rotor thrust</b>	<input type="text" value="10"/>
Rotor thrust in pounds	<input type="text" value="85.34"/>
Rotor offset in inches	<input type="text" value="4.8"/>
Tail Size in square feet	<input type="text" value="2.5"/>









This menu allows you to input the wind velocity and adjusts the following calculations.

Regarding the tail size, the number represented in the program is the minimum size in square ft you should have. It can be any size or shape as long as it has the minimum amount of sq ft area .

-  Rotor thrust in pounds - This is the amount of thrust exerted on the blade during operation calculated by the wind velocity.
-  Rotor offset is for the furling system. This offset is the number of inch's to offset the furling system from the center rotor of the windmill.
-  Tail Size - When thrust is applied to the rotor this is the tail size required by the turbine to keep it stabilized.



## All Adjustments and Effects List

-  Adjusting the rotor diameter effects all numbers in all the tables calculated.
-  Adjusting the tip speed ratio effects the stations ratios, estimated propeller performance rpm, calculated performance generator - ratio; and calculated performance generator - watts recorded ratio.
-  Adjusting the number of blades effects the stations ratios - cord, thickness and drop.
-  Adjusting the angle of attack effects the stations ratios - Bld angle (blade angle)
-  Adjusting the lift coefficient effects the stations ratios - cord, thickness and drop.
-  Adjusting the number of stations effects the stations ratios - station number
-  Adjusting the overall efficiency effects the estimated propeller performance -watts & rpm, all calculated performance generator variables and the recommended ratio.
-  Adjusting the user ratio effects the calculated generator performance -watts recorded ratio

- Adjusting the open voltage effects the calculated generator performance - rpm, ratio & watts recorded ratio
- Adjusting the measured rpm effects the calculated generator performance - rpm, ratio & watts recorded ratio
- Adjusting the measured ohms effects the calculated generator performance - rpm, ratio & watts recorded ratio and the open voltage
- Adjusting the regulated voltage effects all calculated generator performance variables
- Adjusting the wind velocity effects the rotor thrust in pounds
- Adjusting the rotor diameter adjusts the rotor thrust, rotor offset and tail size.



## Estimated Propeller Performance and Calculated Generator Performance

The next menu is the calculated "estimated prop performance and the calculated generator performance". These numbers are not input variables, they are calculated from the above input parameters.

Estimated Prop performance			Calculated Generator performance				
	Watts	RPM	Amps	Open V	Rpm	Ratio	Watts at Rec Ratio
10 mph 4.4ms	60	224	4.05	17.23	666	2.97	83

### Estimated Propeller performance

- The estimated propeller performance numbers given in watts and rpm is the amount of power that can be achieved by the propeller doing work.

### The Calculated generator performance

- Amps - How much amperage can the generator deliver
- Open Voltage - how much voltage can the generator deliver without a load connected
- Rpm - this is the calculated speed in revolutions per minute of the generator rotor.

- Ratio - This is a calculated drive ratio. If your going to use a belt or chain drive instead of direct drive. This example picture above shows almost a 3 to 1 drive or basically running the alternator 3x faster than the prop rpm. What it does is figures out the best possible match for each wind speed then averages it out in the bottom as the recommended ratio. Or you can simply click on the user ratio button and put your number in. Direct drive would be 1 or any other ratio and the watts will show what the unit would do with that ratio.
- Watts Recorded Ratio - This is the generator performance ratio for watts. This ratio reflects the alternator speed in relation to the blade speed. In the program when the user ratio is clicked the recommended ratio is no longer of any use. "watts recorded ratio" is actually "recommended" ratio.



## Using the tables to produce a blade

(optimizing the design)

I have asked Ed to give a brief note on using the program to create a blade. Ed will now describe the principles behind optimizing the blade design and what to look for.

In the break down of data tables, the perfect blade would reflect the watts from the prop and the watts in the generator to match perfectly. For instance if the blade is making 100 watts and the generator is making 100 watts that's a perfect match. Unfortunately this is very unlikely. We have to deal with a wide range of rpm's and there is always an imbalance somewhere in the range.

Estimated Prop performance			Calculated Generator performance				
	Watts	RPM	Amps	Open V	Rpm	Ratio	Watts at Rec Ratio
10 mph 4.4ms	60	224	4.05	17.23	666	2.97	83

↑
↑

You have to design the blade to work within the average wind speed of your area. So if your area was in the 10-20 mph wind range you would try to match the prop and generator to that wind speed as best as possible. If the prop watts are lower than the generator watts the blade will stall and never reach its designed TSR and ultimately never reach its power at that speed. If the prop watts are higher than the generator then the blade will start to spin faster to meet the generator load. This is the optimum, where the the generator and the prop meet.

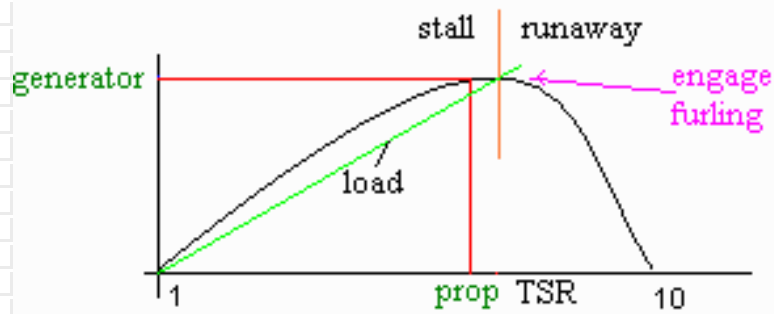

There is a point where the prop will "run away" from the generator. This means the load provided by the generator isn't enough to keep the blades at their optimum designed speed.

This can cause a couple problems...

1. The prop is now running beyond the TSR it was designed for and can cause blade erosion, where the leading edge close to the tips and the tips of the blades will start pitting and cracking... especially in rain or adverse weather.
2. Since the blade is producing more power than the generator, the generator is trying to produce more than it can... this causes heat which ultimately will burn up the windings and possibly ruin a good set of magnets.

If we keep them matched as close as possible the load will control the prop speed and all is well. Usually, where the prop starts to run away from the generator is where its best to start furling the blade. The cause of this imbalance is because the power coming through the prop is cubed and the generator output is linear.

So its a give and take situation... either give up the low end or give up the high end.

## Blade Terminology

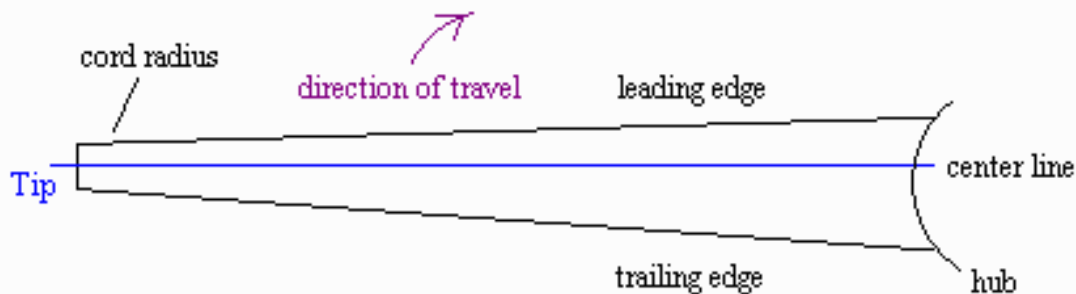

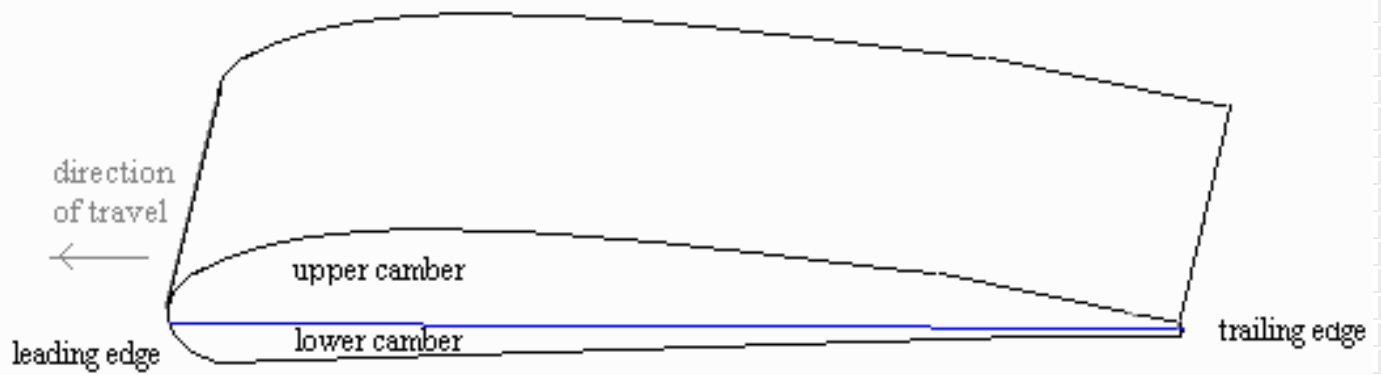

Camber is often used but misunderstood. Defined as curvature in the mean thickness line of the blade section.

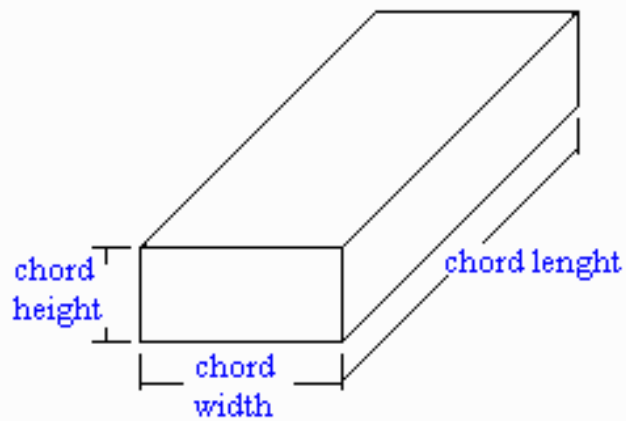

## Building the blade

Station	Radius (in)	Bld ang (deg)	Chord (in)	Thickne (in)	Drop (in)
1	12.	19	9.32	1.4	3.58
2	24.	8	5.24	.79	1.07
3	36.	4	3.58	.54	.49
4	48.	2	2.71	.41	.28
5	60.	1	2.17	.33	.18
6					

This table is composed of the following:

- The station number - stations are markings spaced at intervals.
- The Radius in inch's - The radius of the blade at each station. Section length is the same as blade width. Each station is expressed as a percent of radius increment ( i.e.: 40 radius is 40% of the blade radius) .
- The Blade Angle in degrees - Basically the angle of that portion of the blade when its carved. This is the angle of the blade based on the "drop" and "chord width"
- The Chord in inch's - This is the chord width
- The Thickness in inch's
- The Drop in inch's

This is the calculated station numbers used to produce the blade as follows

- **Please Note:** At this point it is highly suggested that you consult the windpower workshop book for greater detail into the building of the blade. This is only a very basic layout.
- A blade is thickest at the root for structural integrity

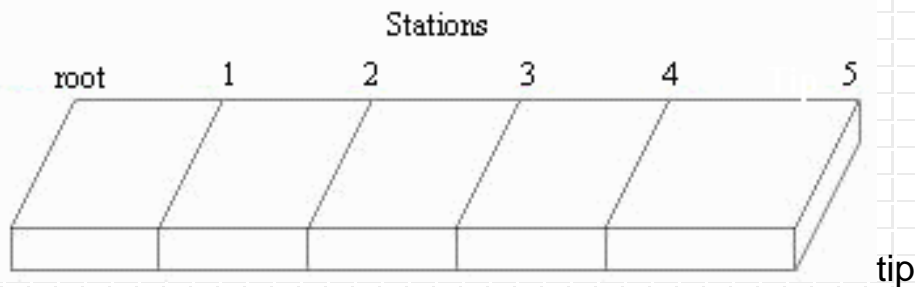

- Mark out the stations, draw the lines completely around the material

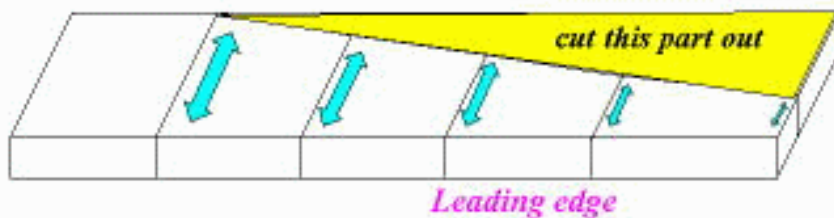

- Taper the blade - mark the width out and cut out parts marked





- Mark the drop of each station

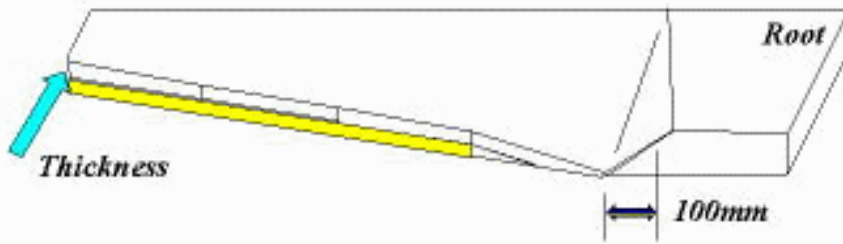

- After carving it looks like this
- Next measure the thickness of each station on both sides and remove the material from the other side

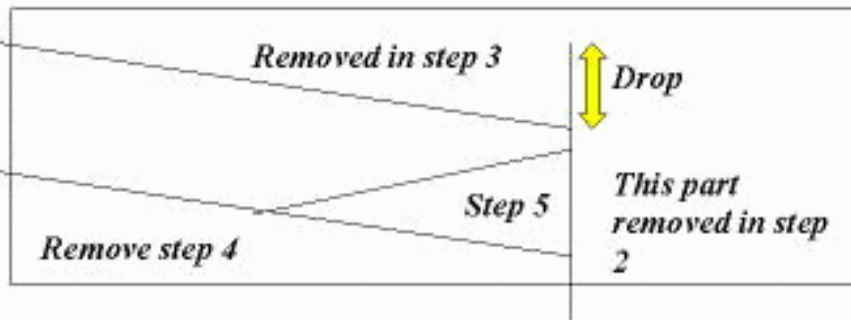

- A cross section of the blade

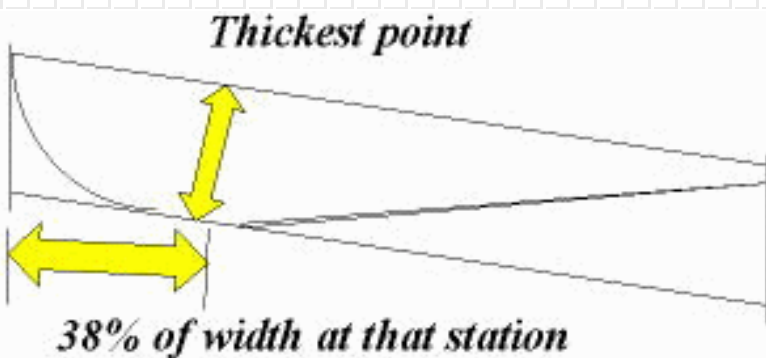

- Another cross section of the blade

I wish you good luck on your project and please send me pictures and web links of your latest projects!

[www.internetfred.com](http://www.internetfred.com)



## Credits

I would like to thank the following people that contribute their talents, inspiration and knowledge each day!

**THANK YOU ALL FOR THE FANTASTIC WORK, WEB PAGES AND IDEAS!**

Ed Lenz - [www.windstuffnow.com](http://www.windstuffnow.com)

Hugh Piggott <http://www.scoraigwind.com/>

Tom S - <http://home.cogeco.ca/~tszaran/indexz.html>

Dan B and Dan F - <http://www.otherpower.com/>

JK TAS Jerry <http://www.dplusv.com/Photo-03.html>



**Get Six Issues in PDF  
For Just \$15!**

You are at: Home

Site Search:

Magazine

HP Archive

Resources

Education

Events

Advertising

Links

Store



## Welcome to Home Power Magazine!

Since 1987, we've dedicated more than 100 issues to home-scale renewable energy and sustainable living solutions. That means comprehensive coverage of solar, wind, and microhydro electricity, home energy efficiency, solar hot water systems, space heating and cooling, green building materials and home design, efficient transportation, and much, much more.

Whether you're a do-it-yourselfer or not, off-grid or on-grid, *Home Power* is here to help you make informed decisions about your home energy use. We provide extensive product information, homeowner testimonials, buyer advice, and "how-to" instructions. More [about us](#).

**Subscribe  
-or-  
Renew**

**Search  
Our Back  
Issues**

### RE Directory

**Need HELP? Locate an RE business in your area:**

**Get a FREE  
Back Issue  
CD-ROM  
With  
Your  
3-Year  
Subscription**



### Featured Articles From Our Current Issue

(In PDF  [Need help?](#))

#### **off-grid** *in town*

A commitment to sustainability and lots of hard work, turned this city lot into a showcase of renewable energy technologies and an oasis of abundant living.

#### **solar** *sense*

What would it cost to power your home with solar energy? Use these simple guidelines to get your solar start today.

#### **step** *by step*

Pole-mount solar-electric panels like a pro. Joe, our in-house wrench, shows you how—step by step.

### Just Getting Started?

**Browse a beginner article about:**

 **Solar Electric Systems** - Perhaps what the home-scale renewable energy (RE) world needs most are ways to introduce people to RE technologies and the gizmos that make it possible. After all, even the best ideas aren't embraced until they are explained in simple terms. So whether you are the rookie who wants to understand how solar-electric systems work, or that better describes your...

**Download a Complete  
Sample Issue for Free!  
Issue #108, August/September 2005**

[Home](#) | [Magazine](#) | [HP Archive](#) | [Resources](#) | [Education](#) | [Events](#) | [Advertise in HP](#) | [Links](#) | [Store](#)  
[Member Login](#) | [Subscribe/Renew](#) | [Reader Feedback](#) | [Contact Us](#) | [Terms Of Use](#) | [Privacy Policy](#)

Copyright © 1987-2005 Home Power, Inc. All rights reserved.

## Assembling and welding the turbine kit

Begin by locating the stator backing plate and bearing hub as shown in the picture below...



Next.. Insert the bearing hub in the stator plate center hole. You may need to take some sandpaper to clean up the hole to get the hub to slip in. It's a snug fit. Make sure the bearing hub is flush with the face of the plate before welding. You don't need to weld all the way around the hub as this is not a structural area, it only holds the stator in place. Four welds equally spaced about  $\frac{1}{2}$  to  $\frac{3}{4}$  inch long is more than sufficient. Be careful not to burn through into the bearing surface. The picture below shows how it should look when it's completed...



**Below is a picture of the welded assembly from the back side of the unit. The welds are placed in line with the stator mounting holes**



**Once this is completed you can weld the yaw tube bracket in place. This is welded between a pair of mounting holes on the stator mounting plate so there is easy access to the holes as shown in the picture below...**



**Notice that the end of the yaw bracket hangs over the end of the bearing hub about  $\frac{1}{4}$  of an inch. Once positioned weld the top and bottom of the yaw bracket to the bearing hub. Be careful not to burn into the bearing surface, especially on the ends or you'll be grinding the edges to fit the bearing.**

**Next find the yaw tube and insert it into the yaw bracket hole. Center the tube in the bracket (about 4 inches on top and bottom). The hole is sloppy so we can add a bit of tilt to the turbine. Lift the**

bottom side of the tube then tack weld it in place. This will add about a 2-degree tilt to help keep the bottom of the blade away from the tower. The picture below shows the tube welded in place...



Next you will weld the angle bracket on the yaw tube. You can weld the bracket to the tail angle mount first or the other way around, it doesn't really matter. What does matter is the positioning of the bracket or assembly before welding. Below shows a diagram... it should be welded 45 degrees off.

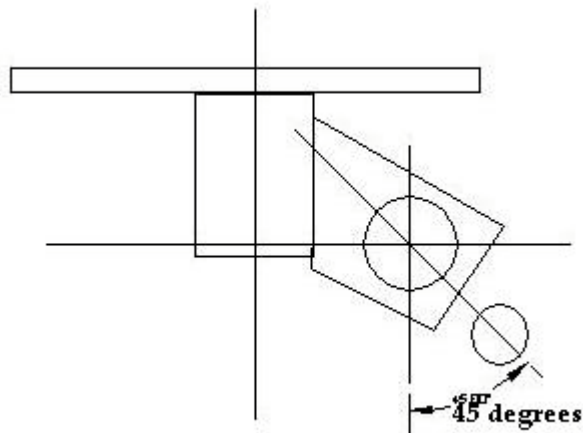

**The final piece to weld in place is the yaw tube stop washer. Simply weld this to the top of the yaw tube. Center it and weld in 3 - 1-inch long welds in 3 places around the tube... As shown in the following picture.**



**Once all is welded let the assembly cool down. Then take a wire brush and clean the welds and remove any splatter that may have occurred. After its cooled it can be painted the color of your choice and the bearings can be installed. When the bearings are installed make sure you tap them in until they are seated against the inner-protruding surface. If they are not then things could go wrong when the turbine is in the air flying. The bearings could move around changing the gap of the stator or even driving the magnet discs into the stator. So seating them is important!**

**Next step is assembling the rotor and installing the shaft....**

**Find the shaft, 1/4" aluminum spacer, magnet plate spacer and one of the 8 inch discs... as in the picture below...**





**Slide the shaft in the bearing hub and install the locking collar on the back of the turbine head and lock it in place. You should have  $\frac{1}{4}$  to  $\frac{1}{2}$  inch of shaft extending beyond the locking collar.. as shown in the picture below...**



**Now slide the aluminum spacer down the shaft on the front of the turbine as shown below...**

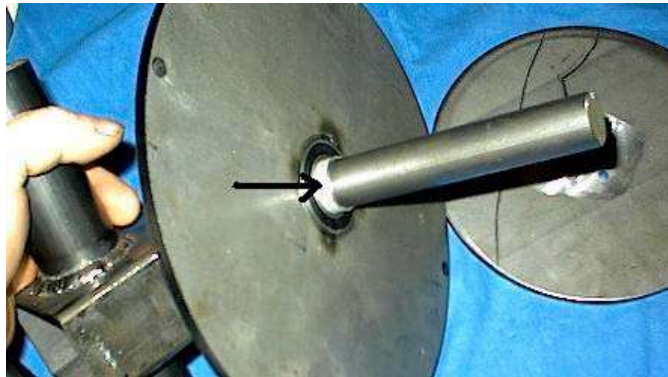

**Slide one of the 8-inch discs over the shaft down to the aluminum spacer... as shown below...**



Install the aluminum magnet disc spacer with the ¼ inch key on the shaft against the disc. Don't worry about bolting them together at this point because were simply going to dis-assemble the shaft in the next step. Tighten the set screw so the magnet disc spacer is locked in place. Now you can remove the locking collar on the backside and slide the assembly out of the bearing hub. Now we'll work on the magnet layout...

There are 12 magnets on each disc, they will have to be positioned every 30 degrees in an opposing layout. So one magnet will go down with its North facing up and the next one will have its South facing up. No need to get all uptight about which is which on the magnet you simply lay down the first one then the next one down must repel the first and all others will repel the one preceding it.

You can lay it out with a protractor or print this sheet out, cut out the layout and mark it on the plate. I use a permanent marker with a fairly fine point for this. Its best to start by drawing a line through the center of two of the mounting bolt holes and mark the top with a star or dot or anything that will identify the top of that plate.

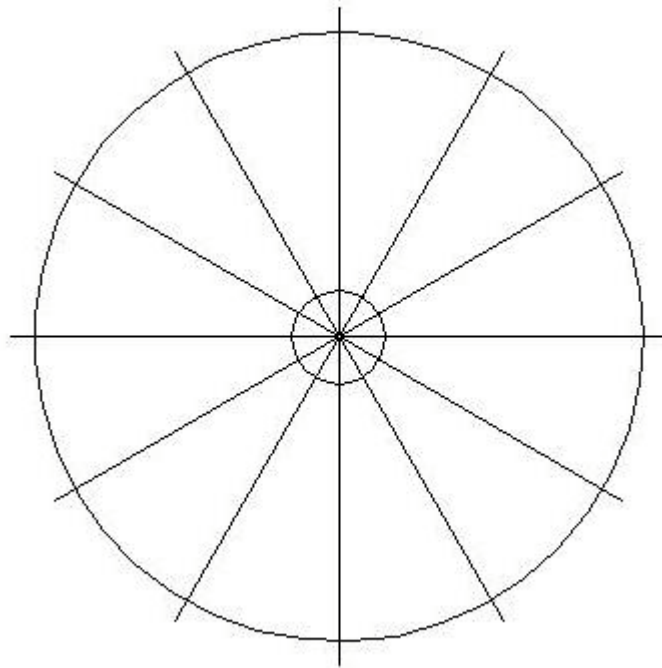

Line up the template so the centerlines go through the centers of the 4-bolt pattern on the disc and tape it in place. Use a ruler to extend the lines onto the disc. You can hold the disc up to a light so it shines through the holes to help line things up. Shown below is the disc with a template taped to it...



Then mark the lines on the disc as shown below

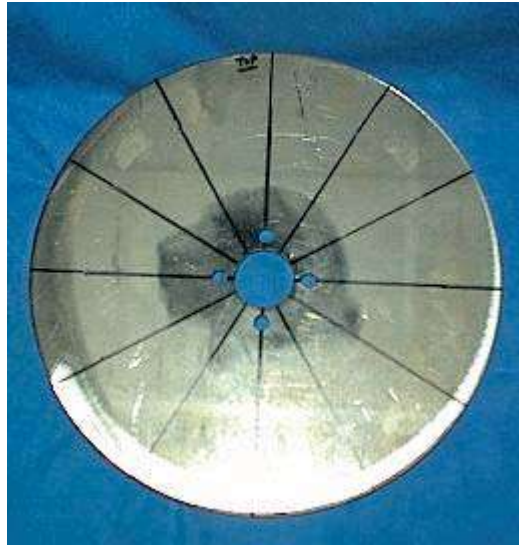

Now the tricky part... You want to make sure the magnets line up before you start gluing them in place. Bring the discs up face to face (markings are pointed at each other). As shown below...

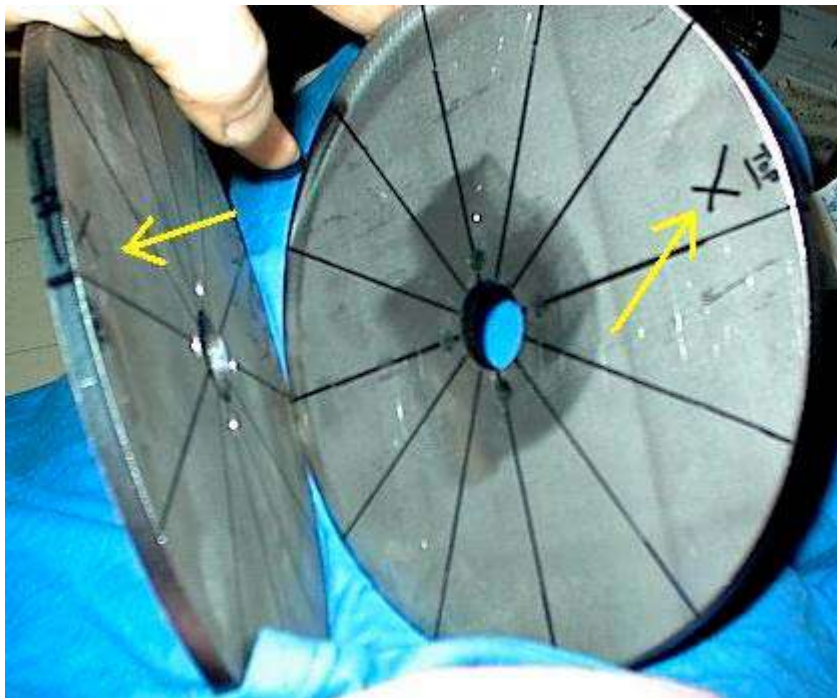

Note that the matching magnets will be mounted on one side of the line on one disc and just the opposite on the other disc. You want to make sure your starting point is where you marked the disc as the top and the bolt holes line up properly. This way when the assembly is complete everything will line up when bolted together. I placed an "X" on the side of the line where the magnet is to be placed.

Now we begin gluing magnets on the discs. **First take note that extreme care must be taken when working with the neodymium magnets.** They like to attract metal things in the surrounding area so

set up a work area where they can be worked with one at a time without any magnetic objects close by.

We'll start by gluing the first magnet to one disc in the appropriate area. It doesn't matter North or south simply glue it in place. I use JB quick weld, sparingly I should add, to glue them in place.

Only mix enough to do 2 or 3 magnets or you'll go through a bunch of the stuff. I use only a small amount under each magnet otherwise it will be difficult to keep the magnets from wondering around until it sets, as well, it will make quite the mess. Also, you want the magnet to stay as close to the disc as possible, too much may have a tendency to hold the magnet up from the disc and not squeeze out giving you a non uniform layer.

Ok so mix up enough JB for one magnet on each disc. The first magnet on the second disc should attract to the first magnet on the first disc. **(Do not put them on the disc and bring the discs together to check for attraction – take one in your hand for the second disc to check for attraction. The attraction side will face the magnet that it is attracted to and the glued surface is pointed away from the magnet on the first disc.)**

Shown below... first magnet on first disc...

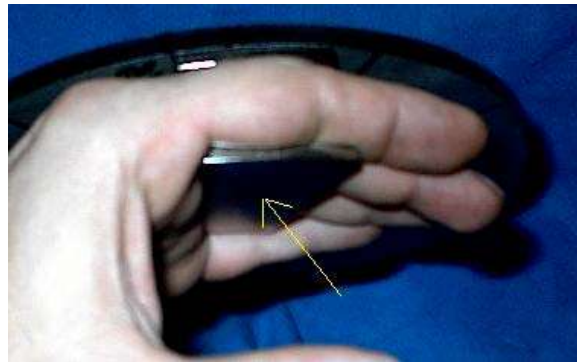

Checking for attraction on the second magnet for the second disc... Carefully!

The yellow arrow shows the surface that will be glued to the second disc in the photo above

Below shows the two discs with their respective magnets in place...

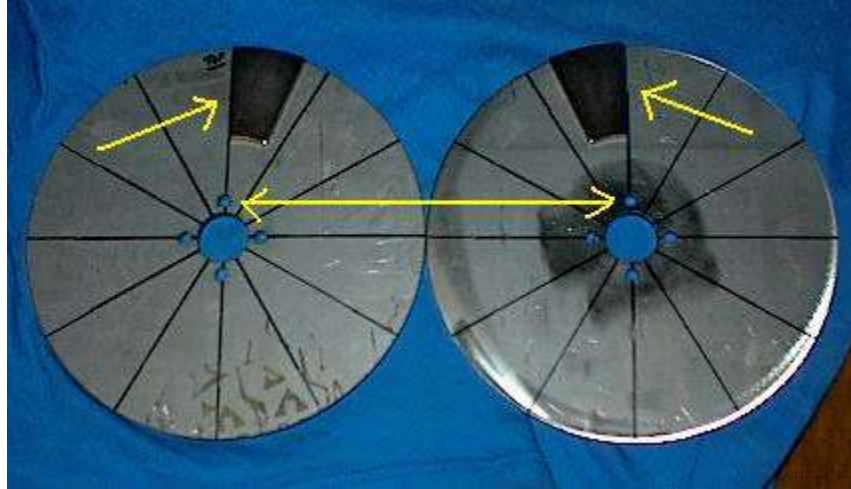

Note the magnets are placed on the opposite sides of the lines you drew and are lined up with the respective mounting hole. When they are face to face the magnets will line up with each other with a very very strong attractive force I might add.

You can double check that you have them properly pole oriented by taking a magnet, at a distance, and check them. One should attract and with the same face the other should repel. Also, to make absolutely sure you have them properly oriented you can take a 2x4 and place the board over one magnet and bring the discs together, if it attracts its fine. If not, it repels then you'll need to flip one over. Its good to make absolutely sure before you get them all glued in place and/or after you've poured the plastic.

Once you have one magnet on each disc then the others can be put into place to finish the magnet installation. Take the disc your not going to work on right away and get it out of the way to assure nothing will be attracted to it while you work on the other.

You can work in either direction as long as you place the magnet on the same side of the line as the first one. Every magnet that goes on the plate will repel the one preceding it. If it repels that is the face that will go down on the plate. Again only mix enough JB to do a couple magnets at a time and don't be in a hurry you may need to keep an eye on the ones previously to make sure their not creeping around on you.

When one is done you can check the polarity of the magnets by taking one and going around the disc, one should attract the other should repel in that order all the way around. If you have two in a row that are attracting or repelling then you'll have to change the one that is incorrect. Once all the magnets are on the disc **put it somewhere safe** then proceed with the second disc following the same procedure as the first.

**NOTE: Under no circumstances should these discs be placed in close proximity of each other except on final assembly. If these discs snap together (magnet to magnet) there is NO way to get them apart with out destroying the magnets and/or discs (not to mention if a body part is between them). When these magnets are placed on the steel disc with opposing poles it creates a magnetic pull of massive force. One disc stuck to the roof of a small compact car will lift it without releasing.**

**BE AWARE OF WHAT YOU ARE DOING AT ALL TIMES WHEN HANDLING THESE DISCS!**

Now that I've put the fear of the discs into you we can move on to pouring plastic around themagnets and finalizing the magnetic plates... Below are pictures of the process of gluing the magnets in place as well as the discs as they progress ....

Below is a picture showing the JB, remember you don't need a big glob, If you use a lot you'll have to hold the magnets in place while it dries and they will want to wonder around. Just a quick wipe of glue will be sufficient.

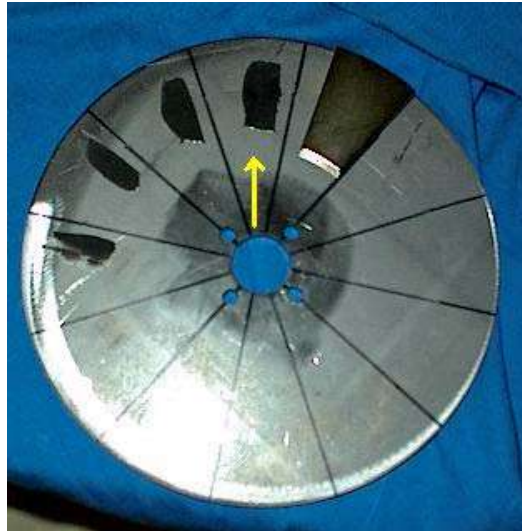

Below shows the magnets glued and ready for the final preparation, note I put an X on the magnets that signifies the top or how the plates will line up with the bolt holes. Once the plastic is poured it's hard to tell which way they went...

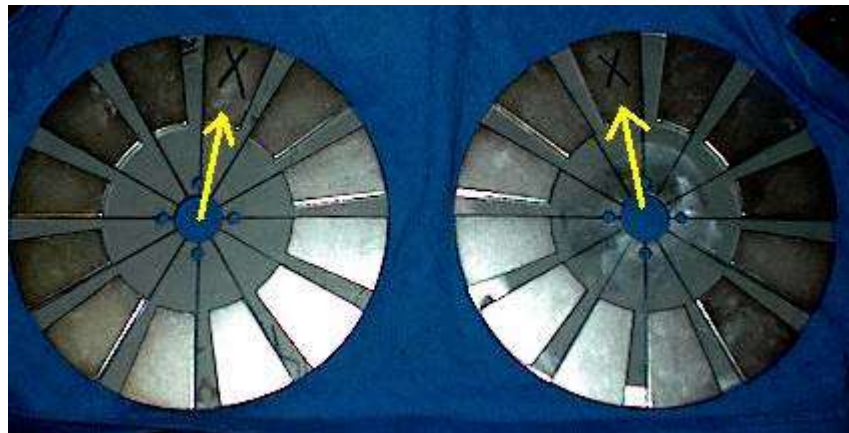

Now, tape the edge all the way around the circumference of the disc to form a lip that will keep the plastic from running all over the floor. Also find a round piece approximately 2 ¼ to 2 ½ inches in diameter for the center. As shown below...

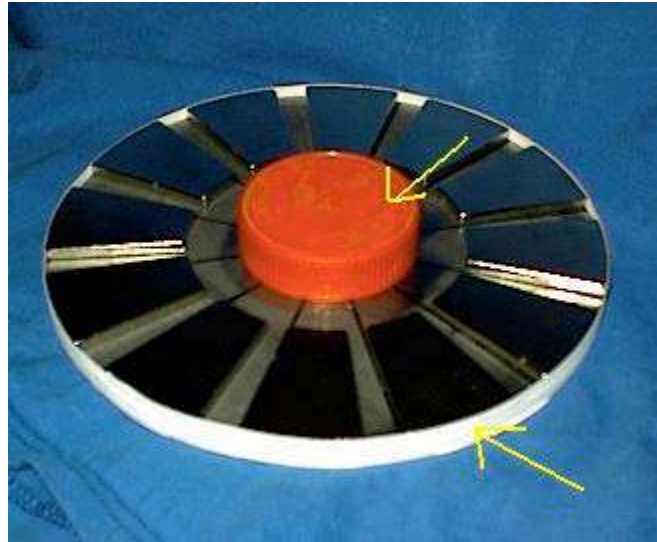

I used some white bandage tape to go around the disc and found a plastic top from a jar that just happened to be 2 ½ inches. You will want to use some grease or car wax around the plastic top where the plastic will fill otherwise the cap becomes a permanent member of the disc. Also, you'll want to find some objects with weight to hold the cap in place while pouring the plastic otherwise it will move around on you.

I used a simple 1 to 1 mix of smooth cast 300 for doing this, it isn't necessary that you use the same thing. A fiberglass resin works just as well and is easy to find at the local hardware or automotive store. The smooth cast is from [www.smoothon.com](http://www.smoothon.com) if you wish to look into it. Its actually quite nice stuff with an easy 1 to 1 mix and it pours like water (almost). It has a very short pot life of around 2 to 3 minutes and is ready to take out of the mold in about 15 minutes so if you mix it you better be ready to use it. Fiber glass resin has a long pot life and usually takes overnight to fully cure so you have plenty of time to work with it.

You can set your discs aside ( in a safe place ) and we'll start working on the Stator... You can paint the parts as you go or paint them all at once before final assembly.

## Building the Stator mold and Alternator

We'll start by building the mold for the stator then get into the nitty gritty of the coils and wiring...

You'll need enough  $\frac{3}{4}$  inch plywood to cut out 2 – 14 inch x 14 inch squares for the base of the mold and lid. The next piece will be  $\frac{1}{2}$  inch plywood cut also into a 14 inch x 14 inch square. The  $\frac{1}{2}$  inch plywood should be of reasonably good grade, sanded both sides and the  $\frac{3}{4}$ " only needs to be sanded one side. I used some rough CDX exterior plywood that wasn't too bad on one side and sanded it myself. The faces have to have a fairly smooth surface to make sure the poured plastic doesn't stick.

Below shows the layout of the stator mold base. Find the center by going corner to corner and draw the lines. I also marked the  $2\frac{1}{2}$  inch center for the center riser, the 4 inch inside diameter of the magnets, the 8 inch outside diameter of the magnets and lastly the 11 inch diameter of the stator mold to help center things up. The center gets a  $\frac{1}{4}$  inch hole to line things up in the beginning.

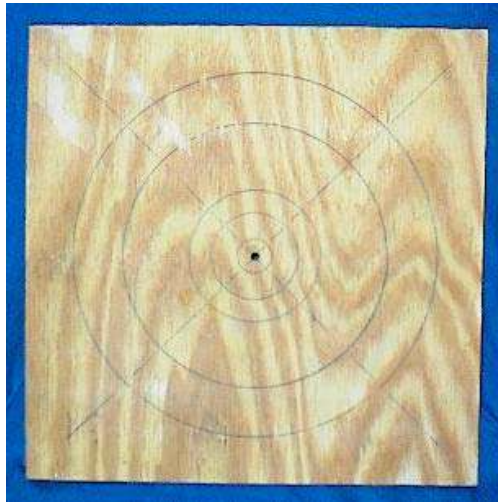

By drawing in the 8" and 4" diameters gives you a reference of where the magnets will be running. Later when you lay in the coils you can make sure there in the right place.

Next, the below picture shows the lid laid out. It's a little hard to see the lines in the picture but the center was marked the same as the base board was and the center is drilled with a  $\frac{1}{4}$  inch drill. The 11 inch circle was drawn then the outer circle is drawn at 12.5 inches. You'll add 2 more lines to the center lines to make an 8 bolt pattern on the lid.

Take the  $\frac{1}{2}$  inch plywood, find center and cut an 11 inch diameter from the center. Use a piece of the



cutout to make a  $2\frac{1}{2}$  inch diameter piece for the center riser and when your done it should look something like this...





You can drill the center hole of the center riser to match the  $\frac{1}{4}$  inch hole in the other boards. I used fiberglass resin on the lid surface and base surface to make sure they were smooth. Also, the resin was sanded to make it as smooth as possible. You could use a varnish or any paint you have laying around as long as it can be sanded smooth. The center board should be coated as well on both sides.

When these are done install a  $\frac{1}{4}$  inch bolt through the center of the bottom board and put the center riser in place sliding it down the bolt. Line up the outer stator with the 11 inch circle drawn on the base. Carefully slide the lid down the bolt making sure the center mold doesn't move. Clamp the assembly together and drill through all 8 holes you drilled in the lid. Try to keep them as straight as possible so the bolts won't go in on an angle. I used a drill that was slightly larger than the  $\frac{1}{4}$  in which will help in getting the lid on when you've poured the plastic.

Below shows all three parts clamped together ready for drilling...

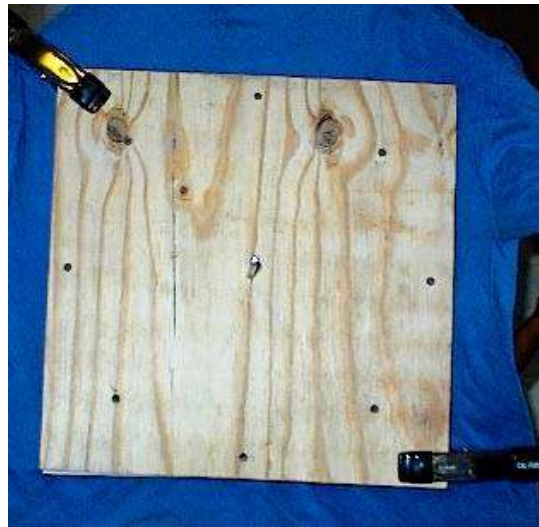

Once all the holes are drilled you should mark one of the edges of all 3 boards so you know which way they go together or simply cut one of the corners off of all 3 boards. I marked them with a permanent marker... quick and simple.

After its been marked for assembly reference you can disassemble it. Drop a few 1/4 inch bolts through the holes of the center mold to maintain its alignment. Next you'll need some 1 inch drywall screws. Drill and countersink in between each of the 1/4" holes you drilled before. Drill the holes just smaller than the screws. If you don't have a counter sink drill you can use a larger drill bit to open the hole at the top to make sure the screws will be below the surface.

These screws will hold the stator mold in place when pouring to make sure the plastic doesn't seep between the two. After pouring the lid will go on and will be secured by the 8 - 1/4" bolts while it cures.



Below shows the stator mold with screws installed, also notice that two screws are placed in the center riser as well.. otherwise it will "float" when the plastic is poured.

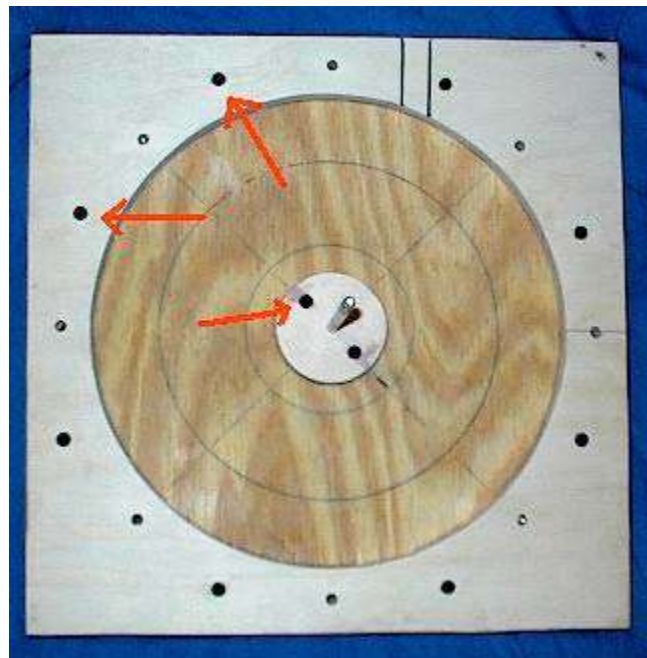

To finish off the stator mold there is one more thing that has to be done before we move on to the coil winding. A slot needs to be put in the lid for the wires to protrude as well as allowing the excess plastic to be squeezed out when the lid is installed and tightened.

The slot needs to be about  $\frac{3}{4}$  inch wide and the hole to start the slot should be drilled just below the 11 inch line. You'll want to sand this slot smooth as well. The picture below shows the slot in the lid..



The slot should be offset slightly from two of the lid mounting holes. Once the slot is completed place the lid on in its appropriate alignment, drop a few bolts in the holes to make sure its aligned and mark the slot on the center stator mold as shown in the above picture where the screws were installed. This will aid in the final wiring process.

Put the mold together and set it aside with all the parts. Next step is winding coils for your stator.

## Coil winding machine and winding coils

Before we can wind the coils we need to build a coil winding machine. Find some scrap  $\frac{3}{4}$  inch plywood and cut 2 pieces  $2\frac{1}{2}$ " x 6", 2 pieces  $2\frac{1}{2}$ " x 4". Bore a  $\frac{5}{16}$  inch hole toward the top of the two  $2\frac{1}{2}$  x 6 in pieces this will be where the  $\frac{5}{16}$  in threaded rod will pass through. Assemble the structure as shown below using  $1\frac{1}{4}$ " drywall screws...

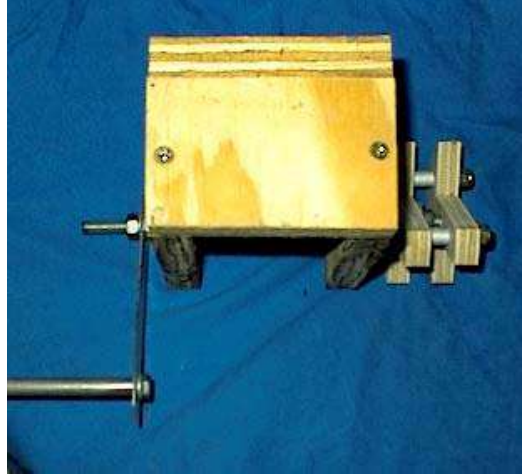
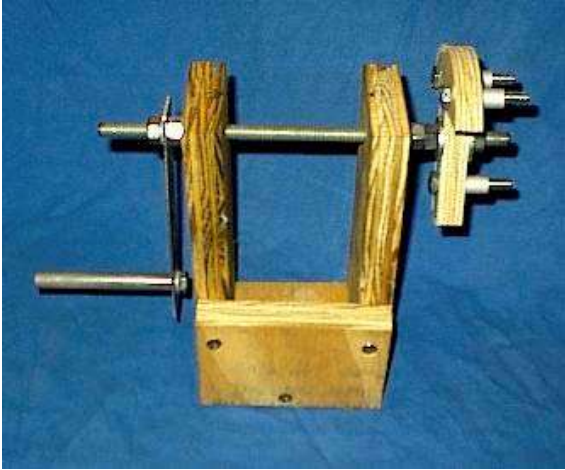

I used some sheet aluminum scrap to make the handle but it can be made of wood or anything handy.

The handle itself can be a dowel held to the arm with a screw, bolt or whatever you can find. No rocket science here, just a simple device to wind the wire. It does need to be sturdy though to wind the coils tightly.

Find the  $\frac{1}{2}$ " plywood piece you cut from the center of the center stator mold ( the 11" diameter) and we will use this scrap to make the coil former. Follow the following drawing to lay out the two discs that will be cut and shaped in the end...

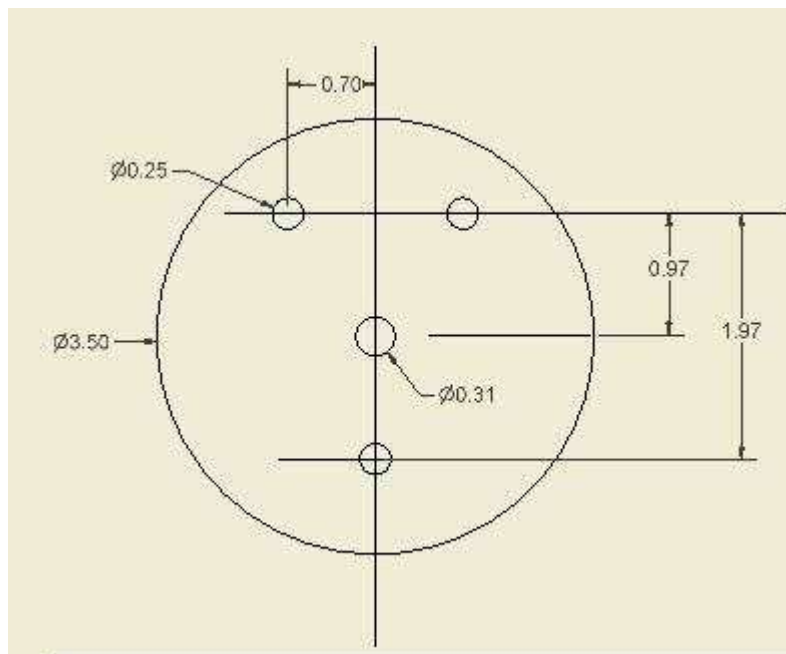

There will be **2 x 3 1/2" in diameter discs laid out as above**. The dimensions that are .97 and 1.97 can be 1" and 2" respectively but the width of the top two holes should be as close to .7 as possible. I usually drill the center 5/16" hole first and put a bolt through them to hold the center then drill one 1/4" hole and put a 1/4" bolt through it to maintain alignment then simply drill through the other two holes. Below shows the 2 discs cut out and drilled...

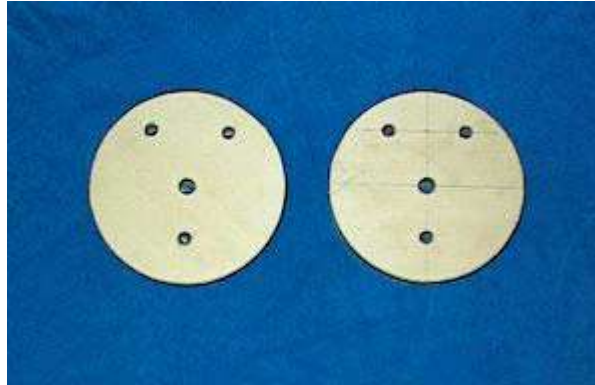

Now shape them to look like a "T". You can cut the top about 3/8" below the holes and the tail is 3/4" wide as shown below...

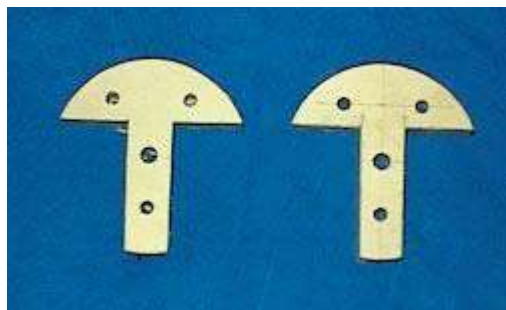

The only critical part is the hole location to make the triangular coils so they fit in place when their completed. The first piece will be tightened against the winding shaft, a washer on each side of the wood former and a nut to hold it in place. This has to be very tight so it doesn't slip while winding. See the picture below...

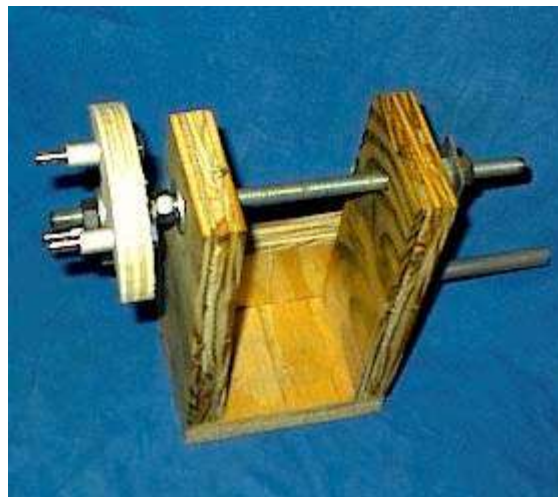

Next you'll need to find some tubing about 3/8" in diameter that a 1/4" bolt will pass through the center. They can be aluminum, copper, steel fuel line as long as their 3/8" in diameter. These need to be cut 1/2 inch long. These will be used as spacers between the wood formers and will make it much easier to remove the coil later. I used some aluminum tubing that I had and cut it with a tube cutter shown below..



The outer former wood will be removed and reinstalled as you wind and complete coils. To make it a little easier to do so you should either hone the holes out with sandpaper or take a drill slightly larger than the holes were drilled including the center hole.

The coil winder is complete and should look something like the below picture...

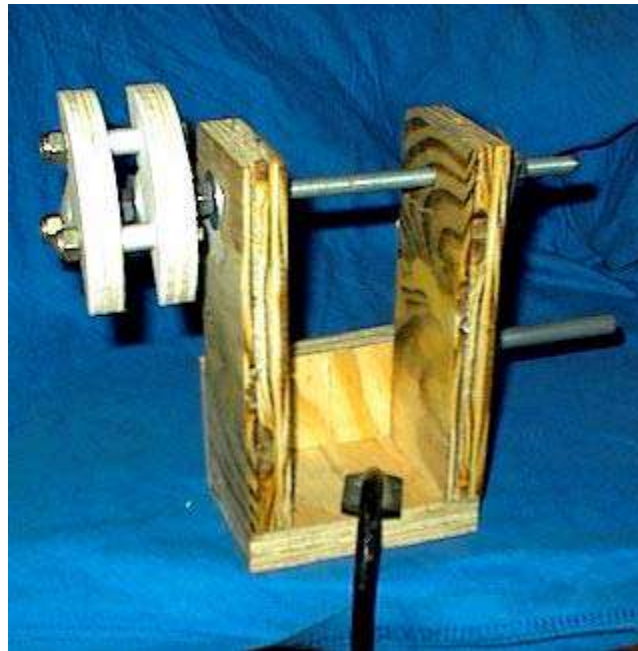

You should clamp the winder to a table edge to hold it steady while winding the coils. There will be a fairly good tension to keep the coils as tight as possible.

## Winding the coils

For the 500 watt 12 volt machine you'll be using #14 wire ( you'll need about 4 lbs of it ). You can use 40, 42, or 44 turns per coil. 44 turns will give you better low wind performance where the 40 turn coils will give better mid and higher wind performance. 40 turns will get a cut in speed in around 7 mph of wind or slightly higher where the 44 turn coil will cut in at around 6mph. Not a big difference except in the higher winds. This unit will make 500 watts in around a 25 – 27 mph winds – about 38 amps at 13 volts.

The stator is a basic 9 coil single layer arrangement, one of the simplest ones to do and it is 3 phase wired in star. The wiring will be covered later. Let's wind some coils...

Starting the coils I take the wire and give it a 90 degree bend leaving about 6 inches of wire hanging out as shown below..

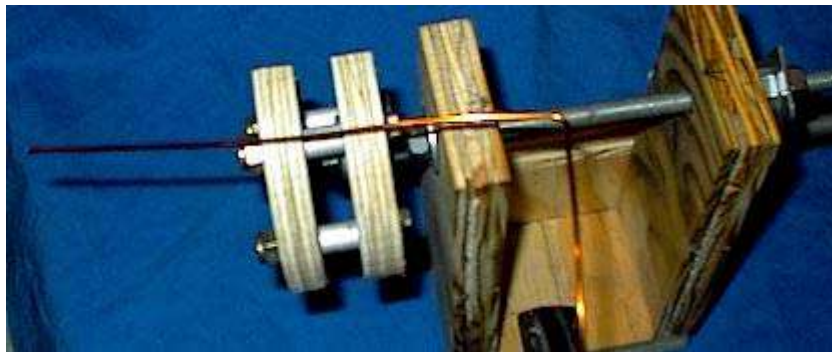

Feed the wire through the bottom of the "T" and the wire should be sticking out the front then give it a turn around the nut as below...

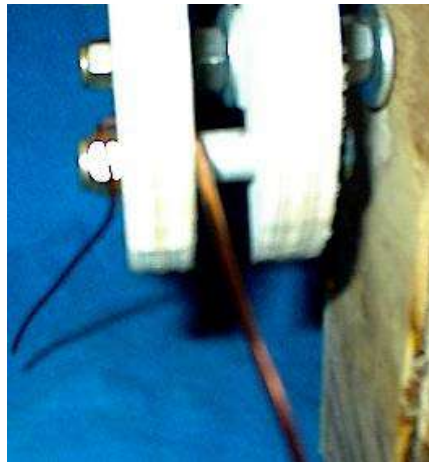

Then simply start turning slowly while holding a good amount of tension on the wire. The first layer should come out to 7 turns . Just continue the same way while counting the turns slowly until all 40-44 turns are completed. Below shows the first 7 turns on the winder...

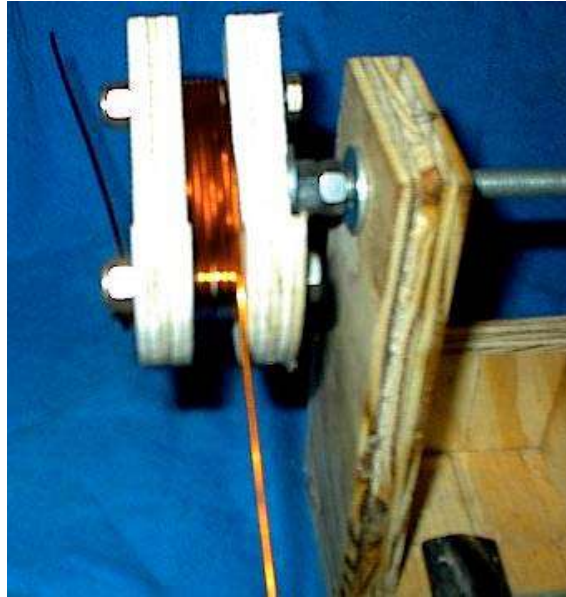

**When the coil is completed use some tape to go around the coil legs and hold them in place. Cut the tail of the end wire about the same length as the start wire. Once its taped on both legs and the wire is cut you can remove the front former and remove the coil. Shown below is the coil completed and ready to remove...**





**The next picture shows the coil still in place with the former removed and ready to come out...**



**Well, if the first one came out ok, you only have 8 more to go! Once all the coils are made we will wire them up and get them in place and ready to finish the stator...**

**Once the coils are done you can lay them out in the stator mold to make sure their going to fit. As shown below...**



If you can't get all 9 coils in place then they probably have a bit of a "bow" to them. The design doesn't leave much extra space to work with so you may need to remove the bow. Below shows a completed coil, the yellow shows where the bow may occur while winding... This will happen on both sides of the coil not just one.



If they don't fit properly in the stator mold then it may be necessary to "tweek" the bow to get them in place properly. Remove the former head from the winding machine and reinsert the coil and put the former together with all the nuts snugged in place. As shown below.

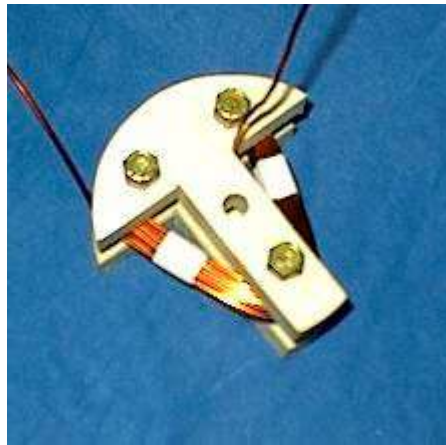

Take a rubber hammer ( preferably ) and tap it just hard enough to bend the stack of wires making them more of a straight line instead of being bowed. Do both sides this way. Be careful not to hit it so hard as to reverse the bow.

Below shows approximately where to tap the wires to remove the bow...



After all the coils have been tweaked, refit them in the mold to make sure you have a good fit. If all fit within the drawn magnet lines then its time to move on.

I've never found the "perfect" way to hold these coils in place while wiring them up so you're in a constant state of adjustment as you go. I start by putting tape over the tape that's on the coils joining the coils next to each other. Like I said not perfect but workable. Once all the coils are taped together we can begin wiring them up.

Below shows the coils taped in place. Also note the coils are taped to the center also as shown below by the yellow arrows...

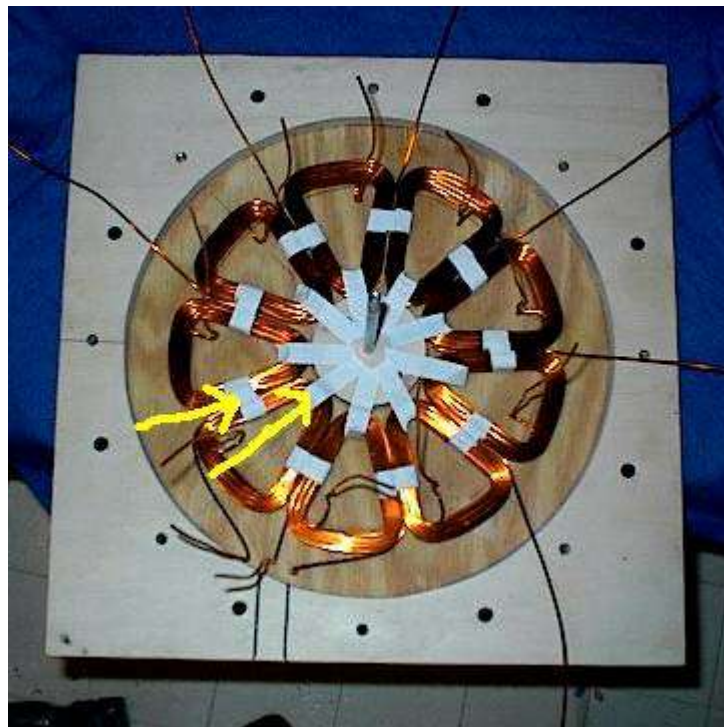

**Below is a diagram of how the coils are wired. This is a star configuration...**

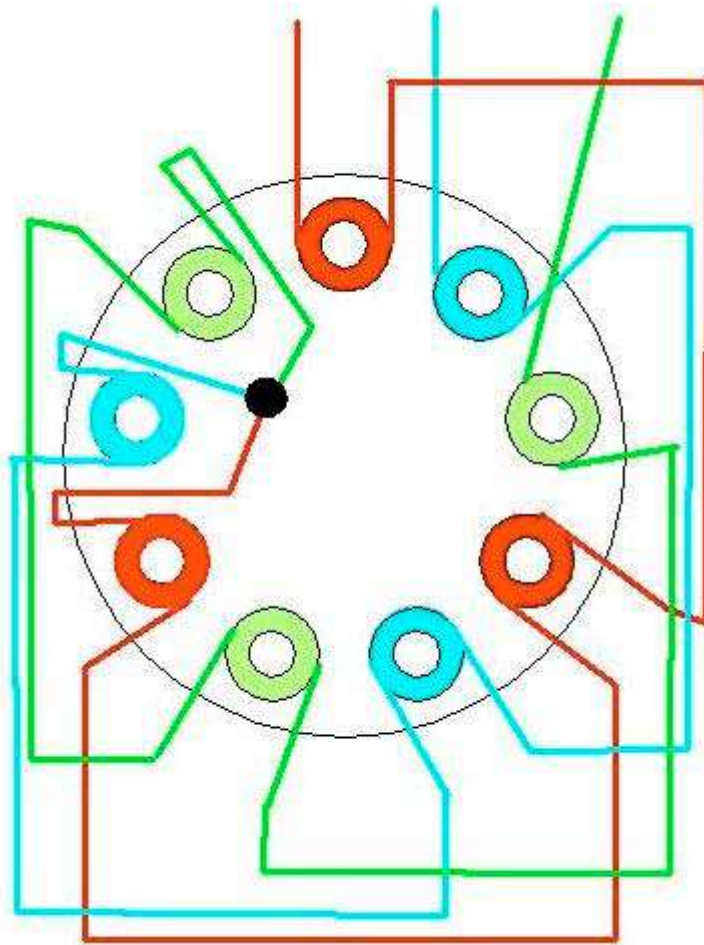

**It can be somewhat overwhelming looking at all the wires sticking out if you've never done this. If you haven't then color coding the phases might be helpful to keep things going smoothly. You can choose whatever colors you have either markers, crayons whatever and mark them as in the diagram above. I usually solder up one phase at a time and double check every thing when each phase is completed. Including making sure there is a good connection with a meter when all is soldered.**

**You'll need to bend and tweek the wires around to get them in place. I usually use the halfway point between the coils to connect them. This way there is plenty of wire and space to work on them. Once you have a pair where you want them take a propane torch and burn off the coating where the two meet as shown below...**



Once the coating is burned it makes it fairly easy to take some sandpaper and clean the copper. You want this as clean and shiny as possible to make sure the solder will stick. If there is any of the coating still on the wire the solder will not hold or make a proper connection. The wire is heavy enough you can hold one end while sanding the burnt area without disrupting the coils to badly...



Once the wire is clean and ready to solder take the two wires and twist them together tightly...

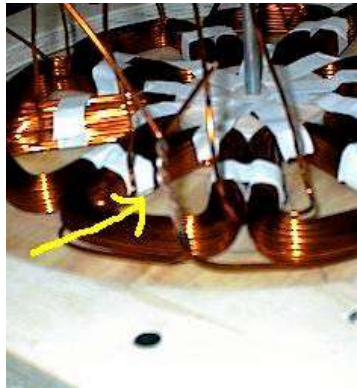

Once their twisted in place solder them up and continue through the first phase. When you've completed the first phase and tested it for continuity the 2<sup>nd</sup> and 3<sup>rd</sup> phases are the same as the first.

When all three phases are complete you'll have 3 start wires and 3 end wires. The three end wires will be cleaned, twisted and soldered together as in the wire diagram above. When all the soldering is completed you'll want to go around the stator and tuck the wires and soldered ends as close to the coils as possible leaving the outer edge clear of wires. You'll be drilling through the outer edge to bolt it to the stator plate later and you don't want to drill through any wires leaving the stator useless.

You'll need to remove the coils from the mold temporarily to prepare it for pouring the resin. I grabbed a board that was handy and laid it over the coils in the mold and turned the mold over allowing the coils to lay on the board. Once the coils are out the mold needs to be waxed so the resin won't stick to any of the surfaces. I used regular car wax on this one, I've used grease as well with good success but its messy.

Once its all waxed up real good, all exposed surfaces you'll need to cut 2 circles of fiberglass cloth that fit in the mold and over the center. One will go in before the coils and the other will be placed on top after its poured.... Below shows the mold waxed, fiberglass cloth in place and the coils reinstalled.

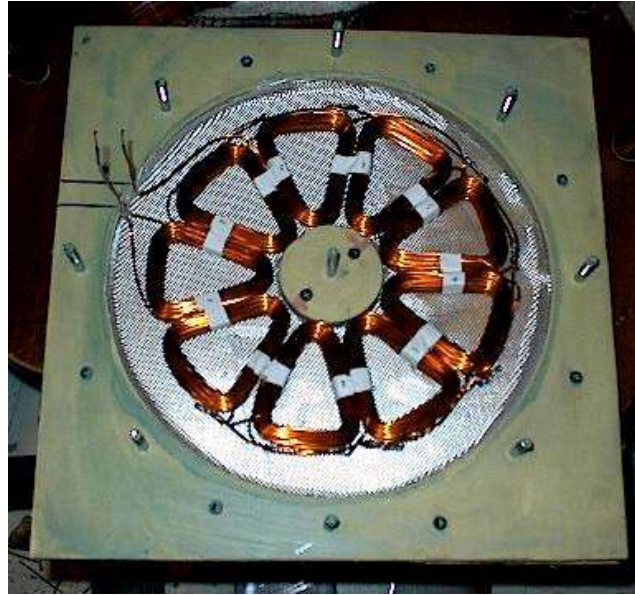

You may have to tweak the coils once again to make sure everything is lined up and in place. Make sure the 3 output wires are lined up with the slot for the cover which should have been marked earlier on the center mold. When your satisfied that everything is in place then place the mold on a level table or worktop with the lid slot pointed in a direction where the spill won't be a problem. Either let the spill go into a box, bucket, can whatever you can find so you don't make a mess.

Mix up about  $\frac{3}{4}$  of a quart in a plastic container of fiberglass resin following the mixing instructions carefully. Once it's poured it's a done deal whether it comes out nice or not. So, take your time and mix it well. Below shows the coils in place and resin poured in...

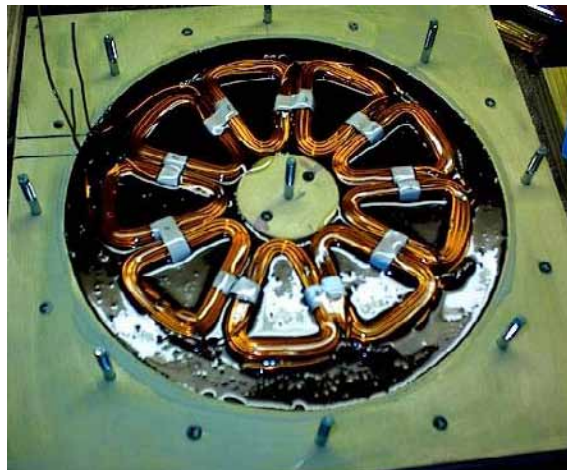

Once its poured take the second cloth circle and lay it over the top of the coils and get ready to put the lid on finishing the stator

Below shows the poured stator with the top cloth in place...

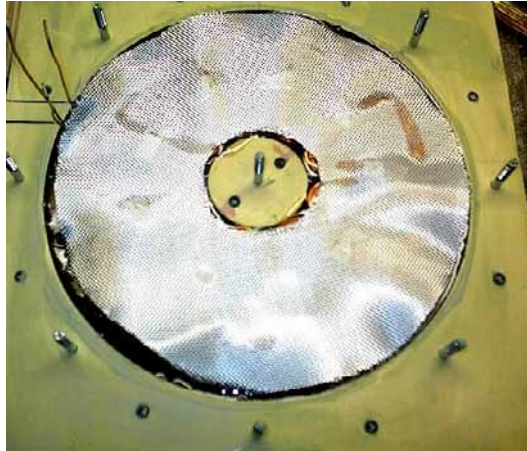

Below shows the lid in place and all the bolts tightened...

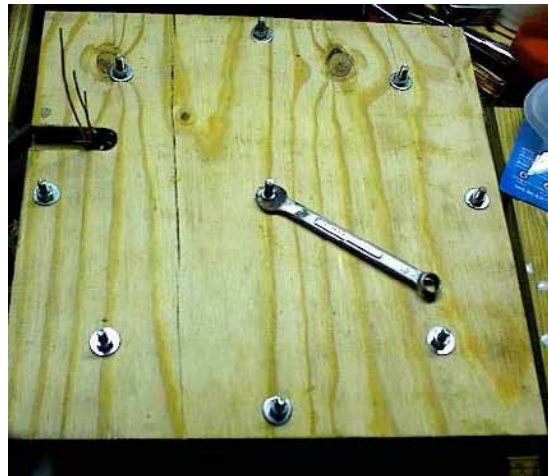

Now let it set for at least 24 hours for a good full cure before opening it up. The waiting is the hardest part...

Once the stator is cured, and all went well you can remove the cover. You may need to use a screwdriver to pry the lid off, if you put a good layer of wax on it, it should come off fairly easily. Once the lid is off remove the lid bolts, if you haven't already, and **unscrew** the center and outer portion of the mold itself. You may have to pry this a little to get it to loosen up. Once it off the bottom board you can tap around the edges to remove the mold board then knock out the center. If all went well you should be able to use the mold again and your stator is ready for drilling.

**NOTE: Be sure to position the output wires in an easy accessible place. You'll be mounting a box to wire the main pendant cable to the output wires later. Usually the side or the top is good but not the side of the yaw tube.**

**Drilling the holes for mounting:** Place the stator over the face of the stator plate and center it. Use a couple clamps to hold it in place and simply drill the 4 - 5/16" holes. If the yaw tube is in the way of two holes simply remove the stator and turn it around. Use a couple 5/16" bolts in the holes you already drilled for alignment and re-clamp it.

You can now assemble your alternator...

Start by getting the main shaft with the magnet disc spacer you positioned earlier. Make sure the set screw is nice and tight at this point because soon it will be impossible to reach. Also, this would be a good time to double check the bearings to make sure they are fully seated in the hub... last chance!

Slide one magnet disc on the back side of the shaft, If you forgot which end is which you can slide the shaft into the bearing hub to make sure. Install the 1/4" aluminum spacer and drop the 4 - 1/4" bolts in place. Note the bolts have one edge ground down for clearance around the spacer, this also serves to hold them in place when your tightening the front lock nuts without having to sneak a wrench in the back. See below... the arrows show the aluminum spacer in place and the flats on the bolts...

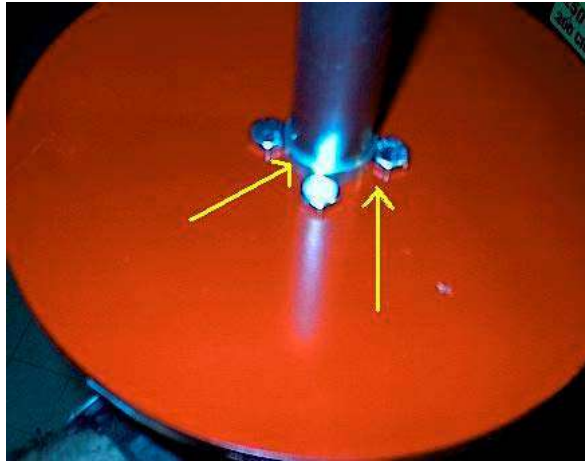

Slide the disc, shaft and assembly in the bearing hub and install the locking collar on the back of the shaft and tighten it in place. Your assembly should look something like the below picture...





Remember the X placed on the “top” magnet? You’ll want to mark the bolt on the spacer with a marker so you’ll know which magnet lines up on the second disc. Once the stator is installed you won’t be able to see the magnet with the X. Install the 4 - 5/16” threaded rods into the stator mounting holes and tighten them. Install the stator nuts and 1 washer on each for the back side of the stator. Run the nuts all the way down to the mounting nuts so the stator lays against the magnet disc. The top nuts and washers will be installed after the second disc is in place.

Slide the stator onto the unit lining up the bolt holes you drilled noting the position of the output wires as well as the direction. You want the wires pointing toward the stator mounting plate. If it goes on hard you can open the holes up a little bit for an easier fit, **don’t force it as it could crack the plastic and you’ll have to start over.** Once the stator is on and against the first magnet disc you can install the second disc. The assembly should look like the below picture... Note the mark on the aluminum spacer for locating the second disc.



**When installing the second disc, Place 1 piece of 3/4” plywood scrap on each side of the stator. DO NOT try to install the disc with out them in place! It could be painful!**

Find the “X” on the second disc and mark the bolt hole on the back side of the disc so you know which one lines up with the rear disc. Slide the disc down onto the plywood pieces. Once its down line up the mark with the proper bolt hole. Remove one piece of plywood from one side and the disc will drop on that side. Use a smaller piece of 1/2” scrap to place under the side you just removed the 3/4” piece from. Slowly remove the other piece of 3/4” plywood until the disc drops into place over the bolts. Then remove the 1/2” piece and it should drop into place. Install the 4 nyloc nuts. They don’t have to be torqued just snug. When completed the assembly should look like below...



**Note the direction of the wires, pointed toward the back of the machine. Now you can install the nuts and washers for the stator and adjust the stator so it rides in the center of the magnet gap. You want the gap on both sides to be close to the same. You should use a loctite blue on the stator nuts so they don't vibrate loose while in operation. These nuts should be tight but not torqued excessively or you could break the plastic.**

## Tail and Furling system

Find the parts for the tail section as shown below...



Begin by welding the top bracket to the pivot tube, then the boom tube to the side of the pivot tube so the top of the tube touches the boom mounting tube. The boom mounting tube has a special 20 degree cut that is shaped to fit the pivot tube. Make sure the two tubes fit together tightly and weld everything in place. When you're done it should look similar to the below picture...



To make the tail boom you'll need a  $\frac{3}{4}$ " schedule 40 pipe about 3 feet long. Preferably non-galvanized because you'll be doing some welding to the end and to mount it. If your kit was ordered as a welded kit then it doesn't matter because it will be bolted together.

Next weld the angle bracket on the end of the  $\frac{3}{4}$  inch tube as shown below...



It's a good idea at this point to find a place that the turbine head assembly can be mounted over a 1 inch schedule 40 tube. We'll be working on getting the "notch" cut in the pivot tube that will determine where the stops are located. This will allow the tail to swing only in a given area.

When the turbine head is mounted slide the tail boom into the boom tube mount on the tail pivot and install the assembly onto the angle bracket on the turbine head. Align the tail so its slightly off from center and mark the tube where the bracket is welded as the picture below...



Mark it just behind the weld, the weld will become the stop so the tail doesn't swing out any farther. Don't mark it at 90 degrees from the head, let it swing out a few degrees farther but not more than 110 degrees. Once you have this mark on the tube swing the tail into its furled position and mark

**the tube on the other side. You want this mark so it holds the tail away from the blades and even a bit farther so its not completely parallel with the turbine stator plate. As shown below...**



**Once it's marked on both sides you need to find the depth of the cut. Measure down from the top of the tail pivot tube to the top of the angle bracket then transfer the measurement to the pivot tube. You want to cut it just slightly higher than that so the slot doesn't ride on the bracket. The pivot should ride on the bracket inside the tube.**

**After the tube is marked for the slot and depth cut that section out... below shows the tube marked for the cut.**



Mark the bottom of the tube so you can see where the cut will start as in the picture below...

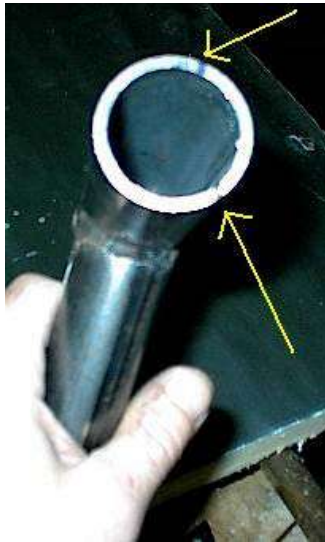

You can use a hack saw to cut the slot down to the depth mark then cut the depth mark down to the cuts in the tube. When the slot is cut out it should look similar to the picture below...



Slide the boom into the boom tube and install it on the turbine head. Check that the normal stop and furled stop positions are where you want them. If you need it to go a little farther you can cut a little extra from either side to finish tweeking it. If it swings to far then you'll need to weld in a piece to make a new stop.

**Note: If you ordered a welded kit this piece is already notched and simply has to be assembled.**

Now if everything is fine then we can make a tail feather for the turbine. I used a piece of  $\frac{3}{4}$ " plywood that was left over from cutting the mold parts, which turned out to be 14" tall by 20" long. You need a minimum of 1  $\frac{1}{2}$  square foot, any size larger than that will work fine. Also, it can be of any shape you want although I'm kind of stuck with simple basic.

After the tail feather is cut out lay it on the floor and place the tail boom on top. The tail needs to be at least 3  $\frac{1}{2}$  foot long minimum. So the tail feather will make up the difference hanging over. Center

it up and drill 3 holes  $\frac{1}{4}$  inch. 2 holes in the angle bracket and 1 through the tube. You'll need 2 – 1  $\frac{1}{4}$  inch long  $\frac{1}{4}$  inch bolts and one 2 inch long  $\frac{1}{4}$  inch bolt with nuts washers and lock washers.  
Shown below is the tail drilled and bolted to the boom...

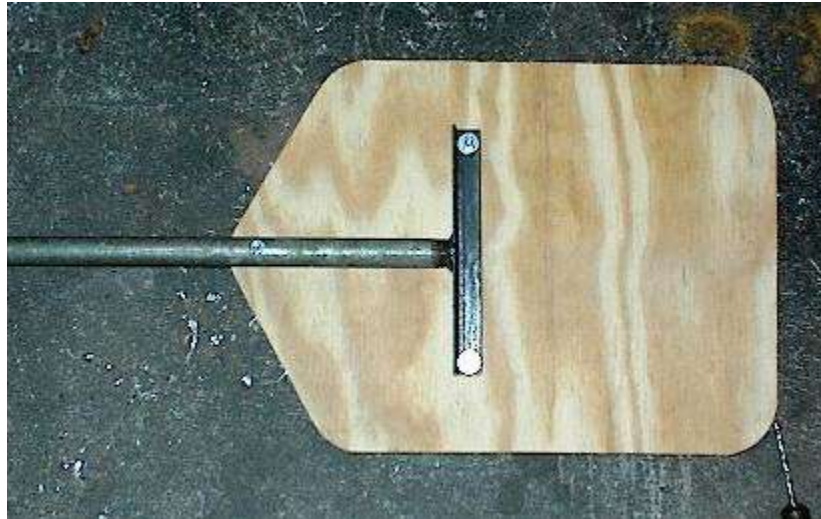

When you're done bolting it up you can align it on the wind turbine head. Slide the boom and tail in the boom mounting tube and make sure the tail is straight up and down. Once its aligned you can drill it for 2 –  $\frac{1}{4}$  inch bolts through all the tubes or weld it in place.

The next step will determine at what wind speed the turbine will furl. You may need to add some weight to the tail. Tap a nail in the end of the tail feather and use a fish scale to measure the tail tip weight. The pivot end of the tail should be setting on the ground and the tail suspended by the scale. You should have about 10 to 12 lbs of weight to get it to start furling in a 25 to 28 mph wind. The weight can be a simple block of steel. Drill 2 holes in it and through the tail board and bolt it on.

Once everything is finalized you can paint the parts and set them aside.

**Note:** To lock the tail on the machine You can drill the center of the tail pivot bracket and make a washer or flat bar with a hole drilled for the bottom then drop a piece of  $\frac{1}{4}$  inch threaded rod through the center. Use nyloc nuts on both ends but don't tighten it, simply let it hang free with plenty of clearance to allow it to move through the furling cycle without any obstructions. This will assure that the tail will remain on the machine. I don't believe it's actually needed but as a precaution it couldn't hurt

Only thing left to do is make some blades for the prop and mount them on the machine. This will be a separate section.

## Blade layout and carving

Starting out you'll need **2 x 6 lumber, 2 - 8ft pieces** should work fine with some to spare... just in case. You should look for some premium 2x6 standard pine studs with reasonably straight grain as well as no knots. Finding them with no knots is pretty much hard to do so look for some with no "big" knots and only real small ones. I use the standard lumber because it's inexpensive and so far they've worked out quite well for me. I wouldn't use hardwood, although it looks nice it's considerably more difficult to work with and its heavy. If you can carry a long board its best to make all 3 blades from the same cut of wood this way your more assured of consistency and density.

So you have your lumber and your ready to start. Begin by cutting the 3 boards 39 inches long. Below is a chart of the dimensions we will use to design the blades. All measurements in inches.

Station	Radius	Blade angle	Chord	Thickness	Drop
1	6	12	5 ½	1 ½	1 ½
2	15 ½	12	--	.88	1 ½
3	23 ½	6	--	.61	¾
4	31 ¼	4	--	.46	½
5	39	2	2 ½	.37	¼

Once the boards are cut to 39 inches find the edge that is in the best shape, one side or the other, this will be the Leading edge. You can mark it with a permanent marker along the edge so you remember which is which as we go. Standing in front of it the leading edge is at the top of the board the tip is to the left and the root is on the right. Measure from the root 6 inches toward the tip and make a mark. If you have a square draw a line across the board. At the tip, measure from the leading edge (top) toward the trailing edge (bottom) 2 ½ inches and make a mark. Take another board or a yard stick and draw a line from the tip at the 2 ½ inch mark to the trailing edge of the 6 inch root line. This will be your blade shape. Now mark the stations radius marks measuring from the root and using a square draw lines down to the angle line. When you're done it should look something like the below picture...

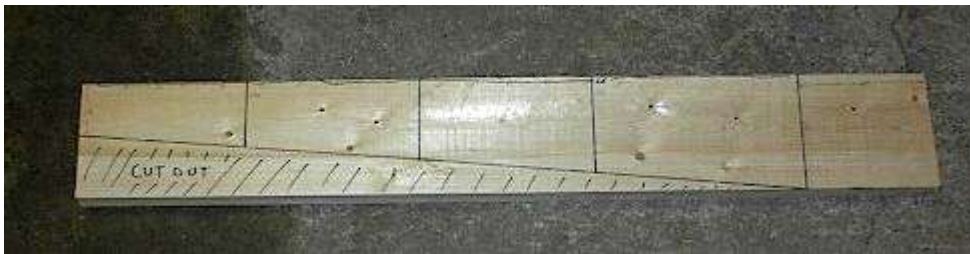



**Now complete the other two the same way.**

**When the other two blades are done you can cut away that portion that isn't the blade shown in the above picture as "cut out". When your done it should look line the below picture...**

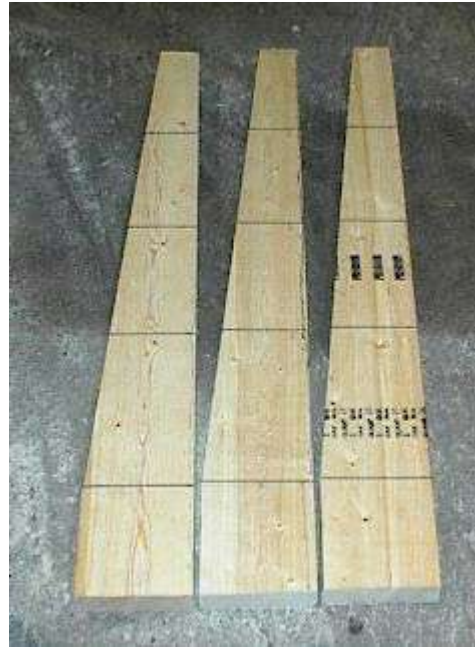

**When the un-needed section is cut off then use the square and draw the lines all the way around all 3 blades. Sometimes to make it easier you can number the stations starting from the first line to the root as 1 and the tip being 5. It helps to remove the confusion as we lay out the blade, especially if you've never carved a blade.**

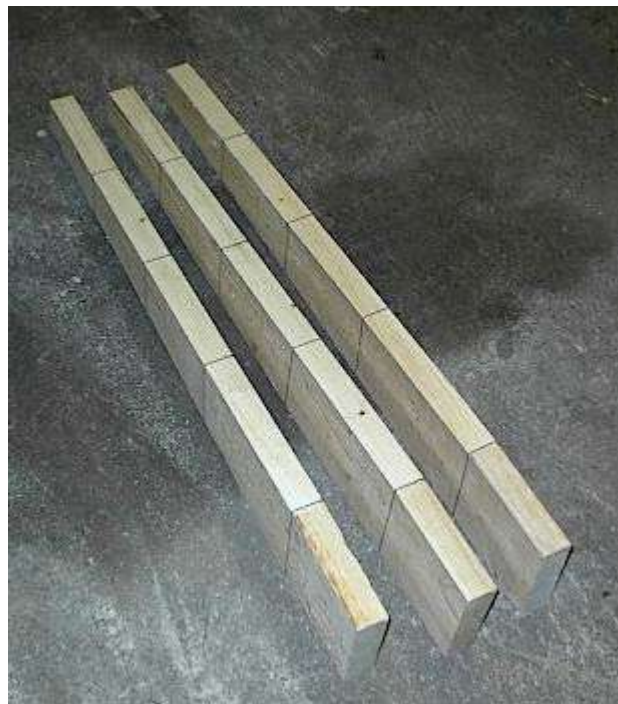

Lay the blade on its edge with the Leading edge upright and mark the thickness at each station from the chart above then draw a line from one station to the next from each of the marks. I used a marker to hi-light the part of the blade that will remain and placed "X's" in the part that will eventually be cut away in the picture below...



Now flip the board over to lay out the trailing edge side in a similar fashion. The trailing edge is a bit different because we have not only the thickness of the blade but the amount of "drop" from the top of the board to form the angle of the blade. Start by marking the drop at each station and draw a line as you did before from station to station. Then measure the width from that line toward the bottom of the board. Once again connect the marks by drawing a line. Notice it looks like the root end will be cut away and the thickness of the area between 2 and 3 runs off the edge. It looks odd right now but it will come together shortly. When the trailing edge looks like the one below then complete the other two in the same process.

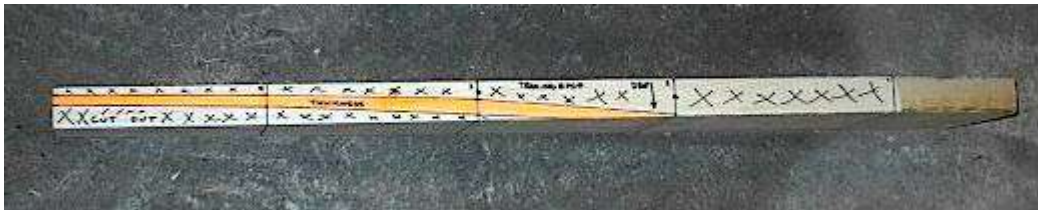

Below shows a picture of the tip with the lines drawn across. This gives you a better idea of what the piece your going to be cutting out looks like... notice I screwed up and drew the airfoil shape in the wrong direction... the darkened area is the correct direction...



I don't like whittling little pieces for a long time to make the blade start looking like a blade so lets make some big chips fly. If you have a band saw things will go quite a bit faster but you do have to watch what you're cutting. If you don't have a band saw you can use a regular hand saw or a hack

saw with a heavy tooth blade. A sawzall works well also, if you're careful. Power tools definitely make the process faster. The elbow grease works well too just takes a few minutes longer.

I should mention that I'm not a wood worker and there are probably other, better ways of doing this. This just happens to be the way I've worked out to make things a bit quicker and it works for me... you may know of better ways to accomplish the same task. I try to make big chunks as quickly as possible to form the blade. If you know of a better quicker way please share it with me...

I'm using a band saw through out these instructions, if you don't have a band saw, a jig saw – hand saw – hack saw will work just fine. Sometimes a little creativity goes along way using the tools and equipment you have.

I started by cutting a  $\frac{3}{4}$ " piece of plywood scrap to clamp in front of the blade so it doesn't cut the leading edge. Once its in place you can lay the blade up against the board and tilt the board in to make each cut. Tilt it out and move it down about an inch and make another cut until the entire blade is slotted. Only cut down to just above the line to leave some sanding room.

Below shows the board clamped to the band saw...

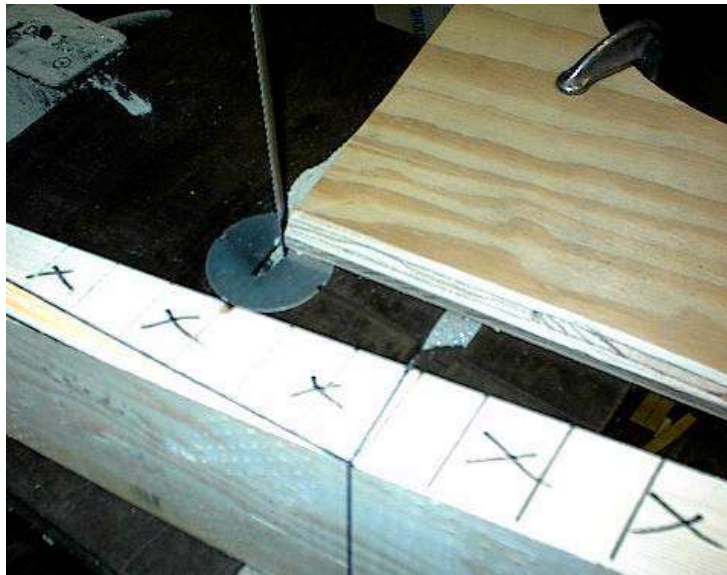

Below shows the start cuts ...



**Below shows the blade being tilted inward to make the slots...**

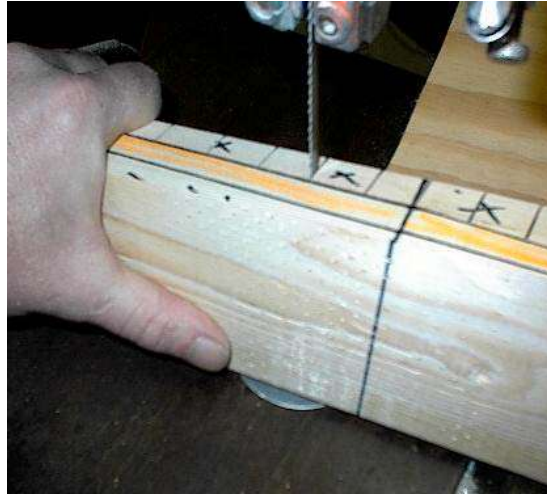

**This will cut the slot at the angle you want and leave the leading edge clean with no cuts. Once you're done with all 3 blades you can start on the other side of the blade.**

**The next cut will remove a lot of material fairly quickly. Since the drop and width are substantial on the trailing edge side of the blade you can remove a good portion of material in one cut as in the picture below...**



**Starting from the tip down to where it runs off the board. Be careful to cut on the outside of the line leaving a little material to work with in the end. Not critical but helpful.**

**All 3 boards can be cut at this time. Here again if you don't have a band saw you can cut slots and later remove the chunks with a chisel.**

**Once this cut is made, you'll need to put the angle cut  $\frac{3}{4}$ " plywood scrap back on the band saw to angle cut the side you just cut. As shown below...**



**Now grab a hammer and a wood chisel and start making chips... This goes fairly fast but you have to be careful and watch the grain of the wood. You don't want to split into the marked area. On the larger chunks where the cuts went deeper you should take them down a little at a time. I usually start from the tip and work my way down to the root as shown below...**

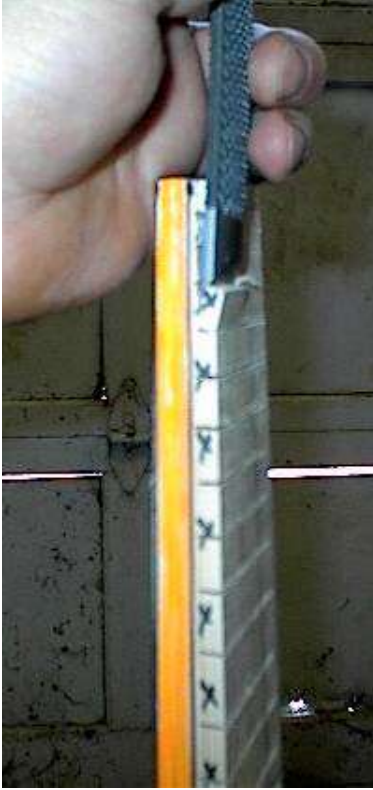

**Remember to leave a little material above the line for sanding and shaping later.**

**Once the chunks are out the blade starts to actually look like a blade...**



**You can do both sides the same way on all 3 blades.**

**Next we'll do some smoothing and shaping on the leading edge of the blade. I use a pocket plane for the shaping. I've used spoke shaves for doing this but be careful not to set the blade too deep. The little Stanley pocket planes are about 4 bucks at the local hardware or lumber store and work quite well. If you have a spoke shave and know how to use it then have at it. Set the pocket plane to only shave off a little at a time and start shaping...**

**Before you start shaping the blade you need to find and mark the thickest part of the blade section. This will be about 35% of the chord back from the leading edge. This will be 1.9 inch for station 1 and 2, 1.4 inch at station 3, 1 inch at station 4, and .75 inch at the tip. Connect the dots with a line and be sure not to cut the line off at this point. Below shows the blade marked...**



**The shaped leading edge should look something like the below picture when done...**



**For the trailing edge of the airfoil I used a full size plane to remove the material fairly quickly also shown in the above picture. That is the rough airfoil shape. You can use the pocket plane to shave down the lines and remaining chunks left before starting the sanding process.**

**Below shows the trailing edge cut down and what would be left before sanding...**



**You can see the blade starting to take shape at this point although it probably still looks like a hacked up mess.**

At this point if you have some power sanders it would be a good time to get them out. I like to put some sandpaper in that is really harsh like 20 or 40 grit. This will take the large surfaces down fairly quick, it'll make lots of dust quickly even with a hand powered sanding block. Do not use this on the leading edge, the heavy grit sandpaper will destroy the curved surface in a couple swipes. You'll want to go to 80 or even 100 when doing a final shape of the leading edge. The heavy grit is only for the large area faces on the trailing edge and the front face.

The airfoil shape doesn't have to be perfect, nor do the blades for that fact as long as their within a reasonable range of dimensions they will work fine. I highly doubt I've ever made a "perfect" set of blades and they have always worked quite well. Below shows a picture of the final airfoil shape next to two blades that have yet to be shaped...



Once everything is shaped then you can get out the lighter sandpaper. I start smoothing with 80 to 100 working up to around 220 grit. If you find a few areas where you chipped to deep you can use bondo to fill the areas. As well, if you knocked out a small knot this can be filled with bondo. Bondo works very well with wood, it's strong and bonds extremely well and is easy to sand. And yes I make a lot of mistakes while carving blades. One other note, the trailing edge should be no thicker than 1/8 inch when your done, typically I try to get them down to around 1/16 inch. The wider the trailing edge is the noisier the blades will be whipping through the air. At 1/16 inch they make less noise than the wind passing through the tree branches.

If the station marks have been sanded off you can remark them and check the thickness at each station as per the chart at the beginning. They should all be within the same range on all of the blades when you're done.

Once the blades are shaped and sanded, all the "boo boo's" filled with bondo you will measure the bottom stubs of the root from the leading edge toward the trailing edge 3 1/2 inches , as well mark the center of the stub at 1 3/4 inches. Cut out the block and it should look like the photo below...





Once the root is cut to a width of 3 ½ inches mark and cut the angles at 120 degrees as shown above from the centerline. This will get them to fit snug in the center for mounting on the prop hub discussed later.

I typically weigh the blades on a postal scale to see how far apart they are. This set was 7 ½ ounces from the lightest to the heaviest. You can try to balance the blades by adding weight to them or balance them after mounting them to the hub. Most prefer the later and I usually add the weight and double check when it's assembled.

Once the blades are formed, shaped, and sanded you can choose the coating of your choice. I typically find the closest exterior latex and paint them up. Color is your choice. Also, after their painted I usually add a stainless steel tape to about 8 inches on the leading edge from the tip toward the root. Since the tips are running the fastest they are most susceptible to the rain, snow, sleet, dirt or what ever Mother Nature throws at it. The tape helps ward off erosion on the leading edge. The tape can be purchased from a local automotive store, it's used as a body patch for a temporary fix from rust holes. Another place to try is Wicks aircraft on the web or JC Whitney.

Next is mounting the blades to the hub and installing it on the machine...

Start by measuring the bottom of the blade to make the first mounting hole. This one must be centered and exactly 1 ½ inch from the bottom. Center should be measured from the leading edge side and should measure 1 ¾ inch. Below shows where to measure and mark the center of the blade at 1 ½ inches up from the bottom...

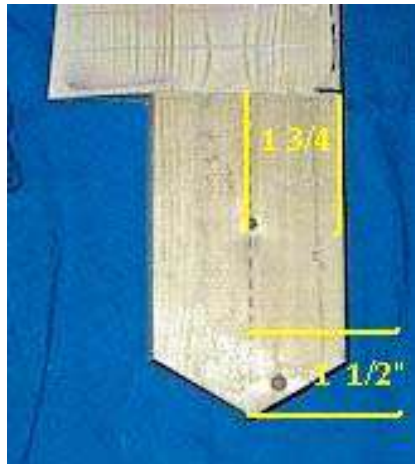

Once you have the blades marked its best to use a center punch. A center drill and a drill press are handy to make sure the drill doesn't wander and the hole is straight through. The hole should be drilled for a ¼ inch bolt to pass through. I recommend using the next size larger in a letter size or honing it out with sandpaper when you're done drilling. You want the bolt to fit nice but you don't want to have to force it in.

When all three blades are drilled for the locator holes you can slide 3 bolts ( you will need 9 – ¼ inch bolts 2 ½ inches long as well as 18 washers and 9 nylock nuts for the assembly ) through the plate and lay it on the floor with the bolts sticking upward. Slide the blades over the bolts one at a time until all 3 are in place then place the prop mounting hub over the 3 bolts as shown below...

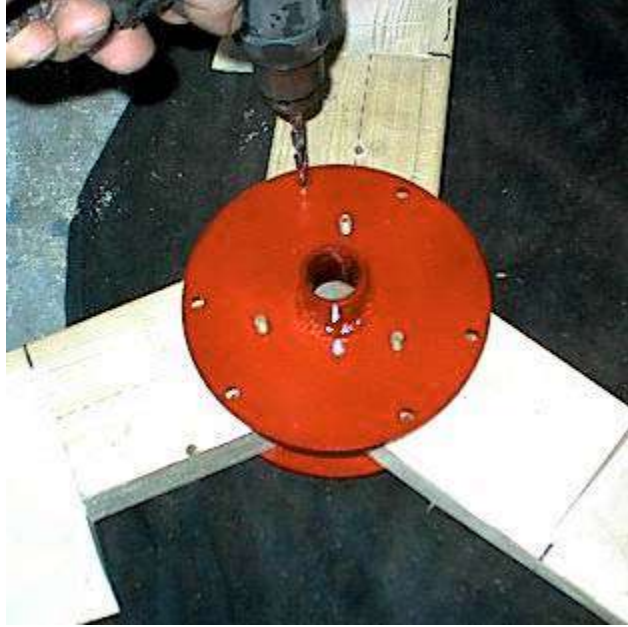

Once it's all in place, measure the blades from tip to tip between each one. The measurement should all be the same or very close. If their not then you may need to tweek the 120 degree angles at the root of the blade to get them to move around where you need them. When their good to go then you can take a hand drill and mark the hole locations for the remaining holes. Don't drill through, drill just deep enough to disassemble them and finish drilling the holes with a drill press. If you don't have a drill press you can drill halfway on one side and finish from the other side keep it as straight as you can.

After all the holes are drilled, finish installing the bolts. No need to put nuts on them at this point. Next you'll need to remove the wood from the center of the hub by drilling the center 1 inch hole. As shown below... ( Note: the picture below is one from another set up which used a plywood backing instead of the steel which is used in this kit)



If you don't have a 1 inch drill you can mark the point on the root at  $\frac{1}{2}$  inch up toward the tip straight across and this will accomplish the same thing. No more than  $\frac{1}{2}$  inch though, it's best to allow the wood to sit on the shaft. You can hone the hole with a larger drill with some sandpaper

taped to the end of it to get the final fit. You want the prop to fit the shaft snug. not hard to put on but also not sloppy.

You'll need a ½ inch wide piece of PVC pipe for a spacer to fit over the bolts protruding from the magnet disc. You can simply butt the prop backing plate against the bolts without any problems but I prefer to use the plastic spacer. **In either case the prop plate must sit against the magnet plate or bolts.** The reason for this, the thrust against the prop will push against everything down to the bearing, if there is a gap then the thrust is against the shaft, in which case the shaft could move inward. If the plate is snug against the disc it will transfer all the forces to the bearing. Below shows a picture of the plastic spacer installed...



At this point you should bolt the prop assembly together with all nine bolts. They don't have to be torqued at this point but snug them up well. Slide the assembly on the shaft making sure its all the way back against the bolts or spacer and drill a ¼ inch hole through the shaft using the prop mount hub as a guide. Its best to drill ½ way through one side then finish from the other when using a hand drill unless your real good at lining them up.

When the blades are painted and the prop is going together for a final assembly you should mark the blades 1,2 and 3 and assemble them as such, this way they will go back together the same way they were assembled. The final tightening of the bolts should be torqued to no less than 100 inch lbs but no more than 130 in lbs. Use a cross-tightening pattern in increments of 40 inch lbs until all are tightened to 100 inch lbs. Let the assembly sit for an hour or so and double check it to make sure everything is seated properly. If it has loosened then re-torque them again and recheck later. After installing the prop on the machine for the final assembly and the locking bolt is installed on the prop hub through the shaft, take a hammer and tap the end of the shaft lightly to make sure its seated against the spacer or bolts and re-adjust the locking clamp on the back side of the machine. This will make sure everything is seated properly.

After the prop is installed you can balance the prop on the machine. The heavy blade will fall while the lighter blades will stay on top. Simply add weights on the lighter side until the blade will stay on one place no matter where it's turned. If you weighed the blades in the beginning and they were close or you added weight to the lighter blades they should be fine when installed although not always true. That completes the blades.



## Basic wiring

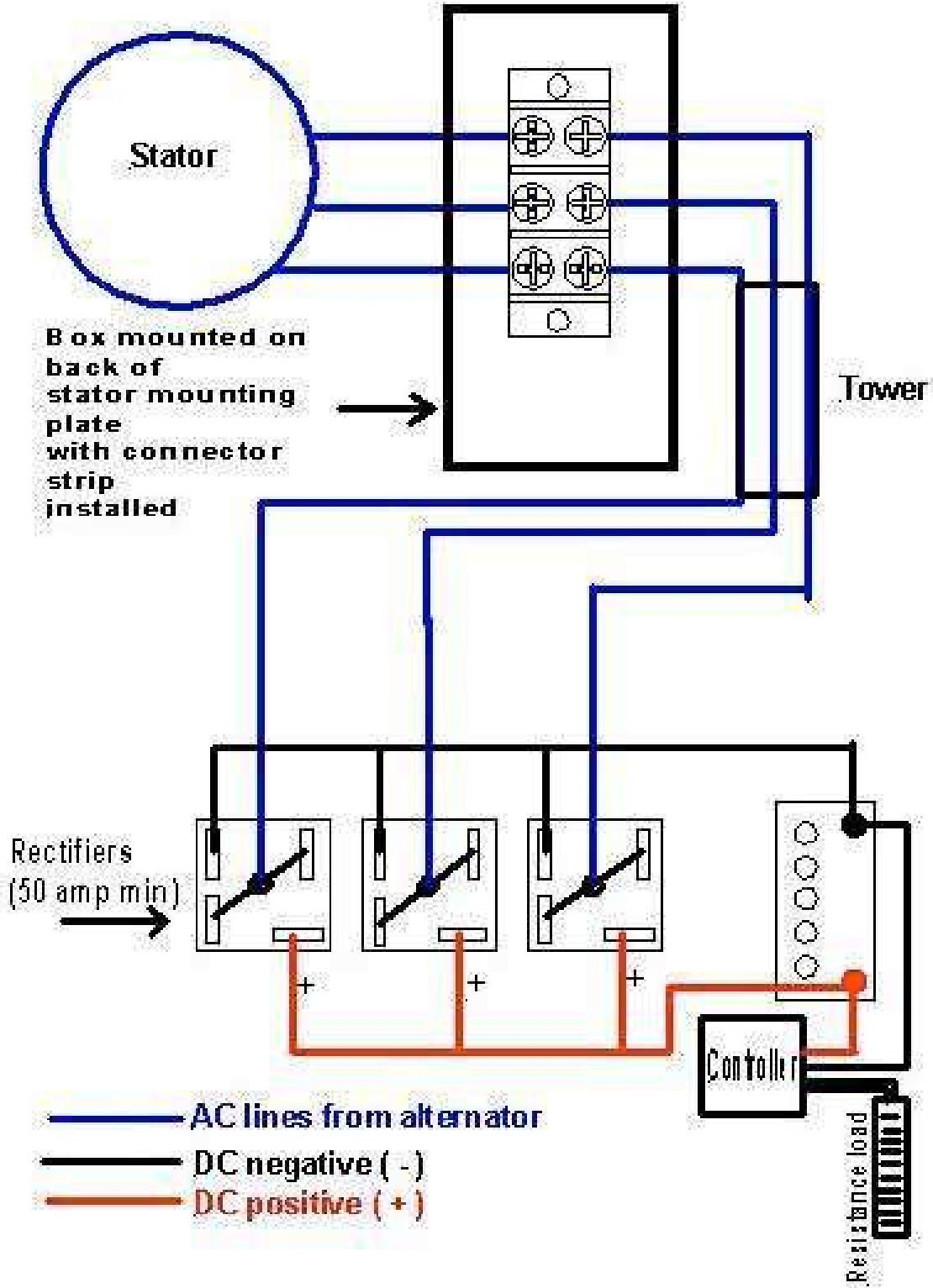

The above diagram gives you a general layout of how the system is wired. You will mount a box on the back of the stator plate to house the wires from the stator and the wire that will dangle down the center of the pole. The box is a basic plastic that can be purchased at Radio shack or other electronics outlet. The size doesn't matter as long as you can get the wire inside comfortably. Mounted inside the box is a connector or terminal strip. Drill 3 holes about the same size as the wire from the stator and slip them through, connect them to the terminal strip and use a silicone sealer over the holes to seal the box from the weather. The cord that dangles down the center of the tower will be a 6-2 with ground standard flexible generator cord. You will need to bore a hole in the box just big enough to squeeze the 6-2 wire into it, connect the 3 wires to the terminal strip and seal around the wire. The cord on the wind generator will need to be fastened by clamp or wire tie's so the weight can't pull it out of the box.

You can convert the AC to DC at the bottom of the tower or run the AC all the way to the batteries and convert it there. I use 3 – 50 amp rectifiers for the system. Each of the pair of AC connectors on the rectifier is used for 1 AC lead from the generator as shown in the diagram.

The DC positive and negative are connected to the battery bank. **NOTE: there should be a fuse on the positive side between the battery and the rectifiers, typically a 60 amp will be fine.**

In order to keep the batteries from overcharging you'll some type of controller. There are many very nice controllers available and you can check the web for different versions. I use a C60 made by Xantrax as a diversion controller into a bank of resistors. You could also use the diversion to heat water or power other devices as well.

There isn't much to the wiring, other than the work to install it depending on your application. In my case I needed to bury 100 feet of 1-0 cable to get it to the house. Took a little time to accomplish digging the trench.

You should check your local electrical regulations to find out what meets code in your area for your application.

## *Assembling your 3phase turbine Kit*

### Turbine Kit Parts List

- |    |                                      |
|----|--------------------------------------|
| 1  | 1 Stator ( slotted thingy)           |
| 2  | 2 Blade mounts ( triangular plastic) |
| 3  | 1 8 inch x ¼ inch threaded rod       |
| 4  | 2 ¼ inch standard nuts               |
| 5  | 1 ¼ inch nyloc nut                   |
| 6  | 2 ¼ inch washers                     |
| 7  | 3 Aluminum Blades                    |
| 8  | 6 Neodymium magnets 1" x .5" x 1/8"  |
| 9  | 3 50 turn coils of magnet wire       |
| 10 | 15 #4 x ¼ phillips head screws       |
| 11 | 6 N4001 diodes                       |
| 12 | 1 3 ½ " steel disc                   |

### Tools you will need to assemble this kit

#### **Drill**

**3/32 drill bit**

**1/8 drill bit**

**¼ drill bit**

**#1 Phillips screwdriver**

#### **Pliers**

**7/16" wrench**

**Tape**

**Super glue**

**Mild grease or oil**

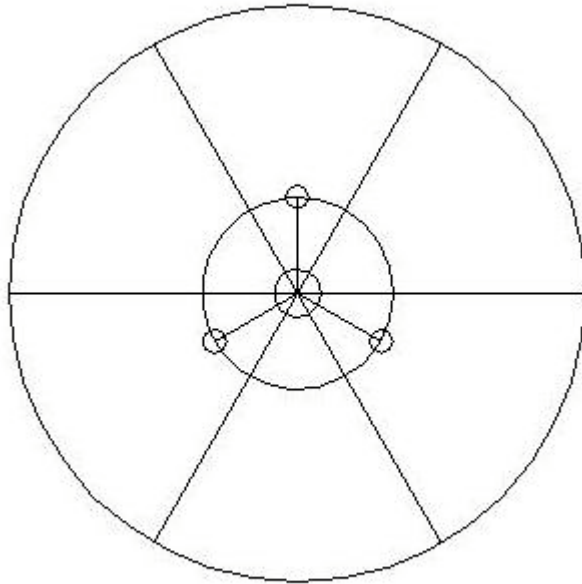

Start by finding the steel disc and cut out the template above. A flashlight is handy to line up the center hole. Lay the steel disc on the flashlight and lay the template over the disc. Line up the center hole with the light shining through the hole. This will center the template. Tape the template in place and use a center punch to mark the 3 holes. Use a marker to mark the lines on the disc where the magnets will be placed. Remove the template and drill the marked 3 hole locations using a 1/8 inch drill bit. When this is done take a ruler and connect all the lines on the disc. This will be the placement of the magnets. The two triangles have small divits in the sides and top. Use a 3/32" drill bit to drill into these divits.

Continue by locating the steel disc, triangles, 2 washers and threaded rod as well as the 2 standard nuts as shown below.

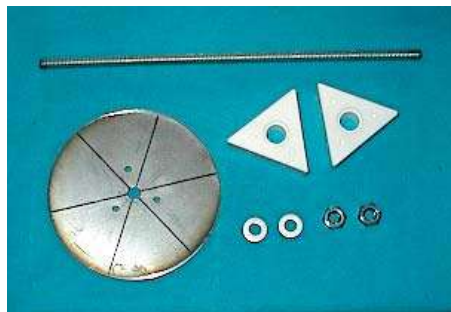



Take one of the nuts and screw it on the threaded rod about 2 inches down. Place one of the washers on the rod and one of the triangles with the washer groove toward the washer. Place the second triangle on the other one with the washer groove up as well as another washer. Install the steel disc with the lines showing and install a nut. Line up the 3 holes in the steel disc with the 3 holes in the triangle. Install the 3 screws to hold the disc in place. This assembly is to assure the disc is centered on the triangle. Below shows the assembly jig assembled.

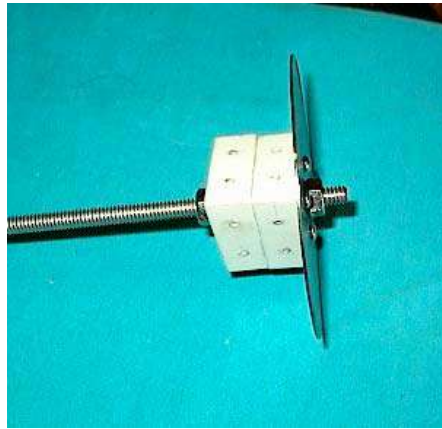

Remove the disc and triangles from the rod and find the 3 turbine blades. Install one turbine blade on the triangle attached to the disc. Attach the other triangle to the top of the blade. Make sure you have the washer groove upward and the triangle lines up with the blade. Below shows the first blade assembled and the turbine assembled.

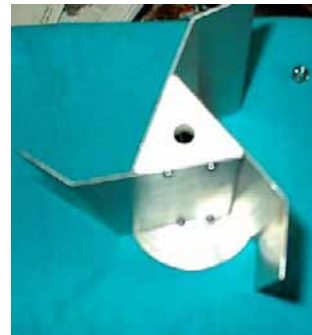
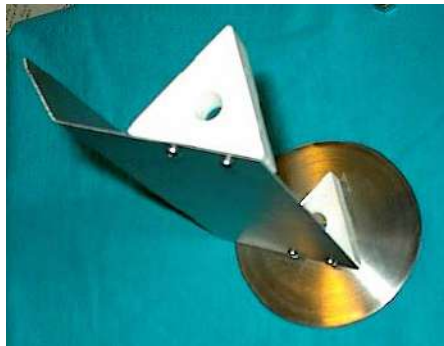

Flip the unit over showing the steel disc and find the magnets. The magnets have to be placed on the disc with alternating poles. Such as North, South, North, South etc. It really doesn't matter which is north or south as long as they alternate. The simplest way

to do this is to place the first magnet down on the disc centering in on one of the lines. These can be superglued in place if necessary.



Take the next magnet and hold it a distance away from the magnet already on the disc, If it attracts then flip it over... it should repel. This is the way it should go down on the next line same as the first. Remember the magnet should repel the one before it. The rest of the magnets can be installed at this point. When you get to the fifth one it's a good idea to double check your work using the last one to test the poles. Circling the poles one should attract the next repel and so on. The last magnet will repel both the ones beside it.

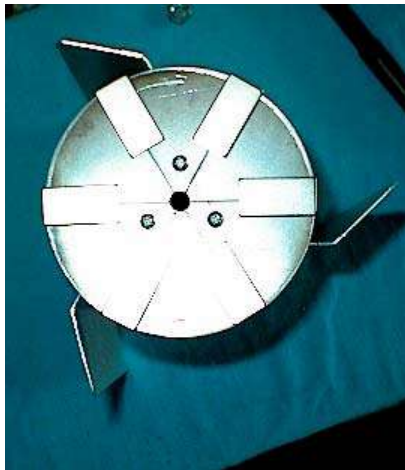

This portion of the turbine is completed for now. Set this aside and find the 3 coils of wire and the stator ( slotted plastic thingy). As shown below...



Untwist the coils and take one from the three. Notice there are two wires coming out from the coil. One wire is short and one is longer. When installing the coils the short wire should be on the right hand side. The short wire represents the “Start” of the coil and the long one is the “End” of the coil. Using some tape and a marker label the ends of the coil 1S and 1E. A fine point sharpie works nice for this. Below shows the coil with the ends labeled...

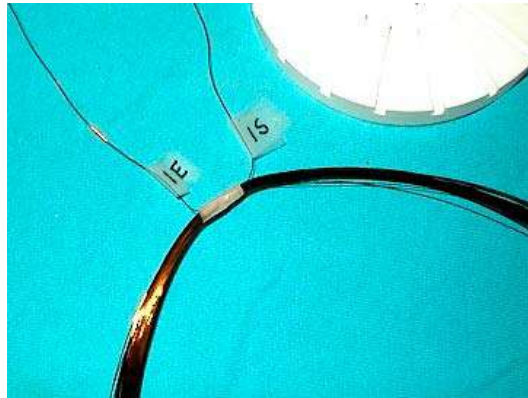

At this point you should get some tape ready to help hold the wires in the slots as we go along. Cut 6 pieces about 1 inch long and stick them to the table edge or somewhere easily accessible. Bend the wire to a 90 degree angle just left of the edge of where the two wires come out of the taped connection. You can place this in any slot to start with and place a piece of tape over the slot to hold the wire in place as shown below...

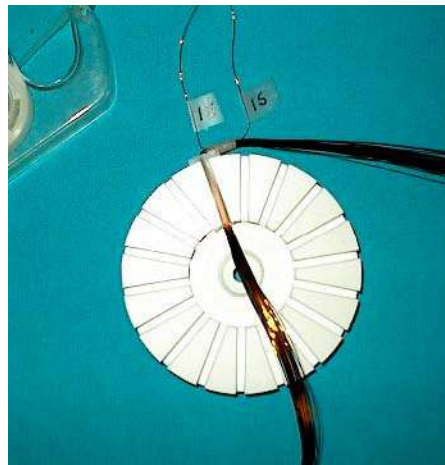

Bring the bottom of the wire, leaving a small loop while skipping two slots back up through the slot as shown below....

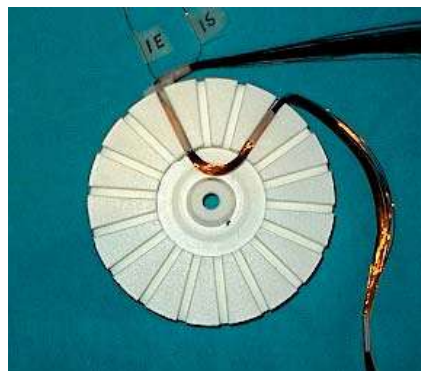

The top wire will come down through the same slot forming one of the six coils to be completed. A piece of tape covering the slot will hold the wires in place once again. The picture below shows the completed first coil...

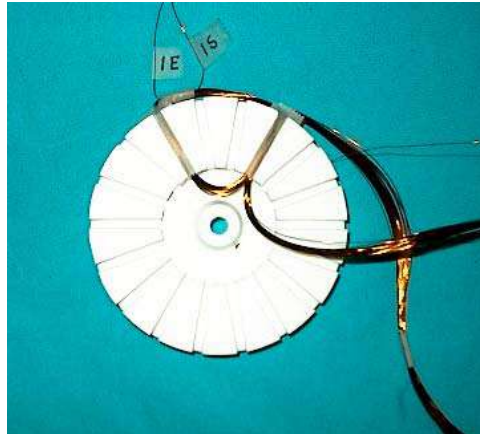

The next coil will be similar to the first, skipping 2 slots, the bottom wire goes up through the slot and the top coming down through the same slot. A piece of tape to hold the wires in the slot. Below shows the next coil in place...

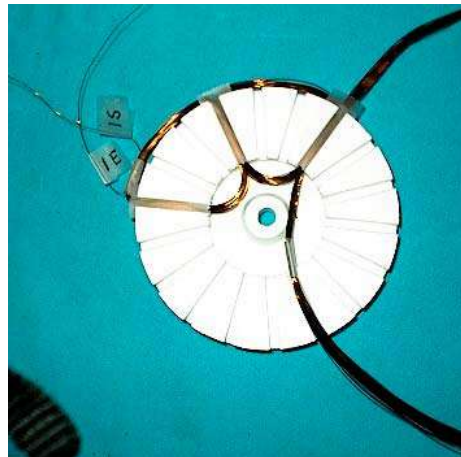

Continue on until all the coils are in place. The last coil will share the same slot as the starting coil. You'll have to pull the tape up, install the wire and replace the tape. When completed should look like the one below...

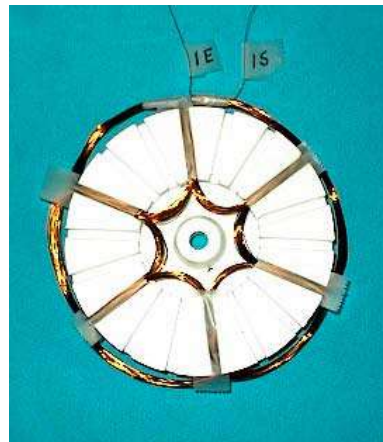

Now you have completed all the coils of one phase. You've just created a single phase alternator. The next two phases will go in the same as the first. The next phase will start in the slot directly to the right of the start of the first phase. Start by finding the long and short wire as with the first coil and label the start and end as you did with the first only this one will be labeled 2S and 2E for the second phase. Shown below is the beginning of the second phase...



Follow the same pattern as you did with the first phase and using tape to hold the wires in place. Below shows the second phase in place...



Proceed with the third phase the same as the first two filling the remaining slots. Shown below is the first coil start and the completed stator...

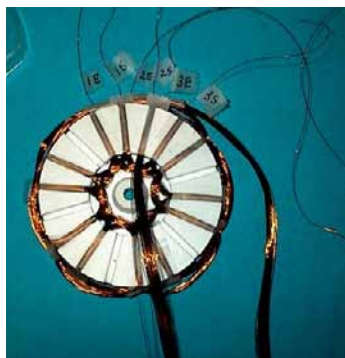

That completes the stator at this point. Assembling the stator to the turbine is a simple step. But, before we continue you should decide on the base. The base can be a board with feet which I will show in the following assembly or you can use a PVC pipe plug that will fit a pole to mount it on. Simply drill a hole in the plug and bolt the stator to the plug. Makes a nice pole mounted unit for experimenting. For simplicity I've chosen to make this one on a wooden base. A simple square of wood and 4 feet has been made for the instructional version. Below shows the base ...

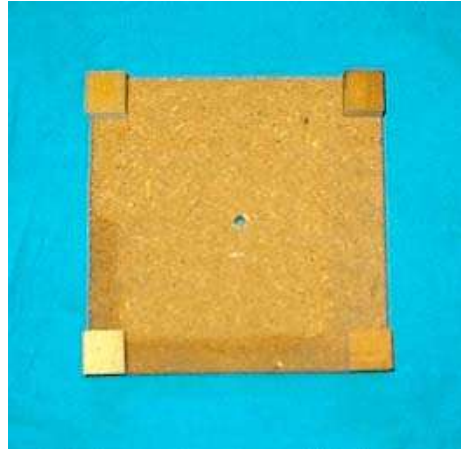

A  $\frac{1}{4}$  inch hole has been drilled through the center for mounting the stator and 4 wood feet glued to the base. Mount the stator using the threaded rod and two nuts provided in the kit. Below shows the stator mounted to the base...

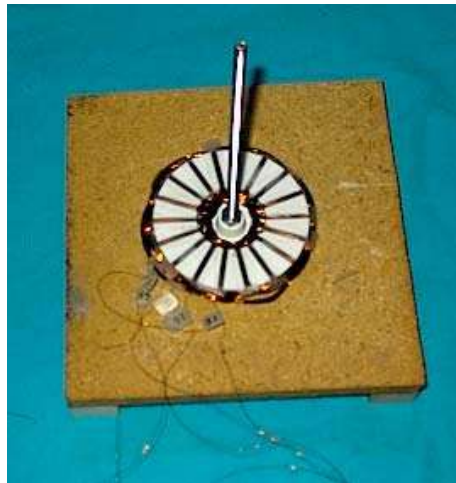

Slide the magnet end of the turbine unit over the rod, install a washer on top making sure it drops into the washer groove of the triangle and install the nyloc nut provided in the kit. When tightening this nut make sure its not tight against the washer but not loose enough to allow the washer to jump out of the slot. The turbine should rotate freely. Make sure the magnets are not hitting the stator or wires and rotates without much friction. If the lower hole is difficult to install on the rod you can run a ¼ inch drill through the hole to make sure its free of burs. Also a little grease or oil can be applied at the top and bottom pivot points to further reduce any friction created at these points. Below shows the completed turbine on base...

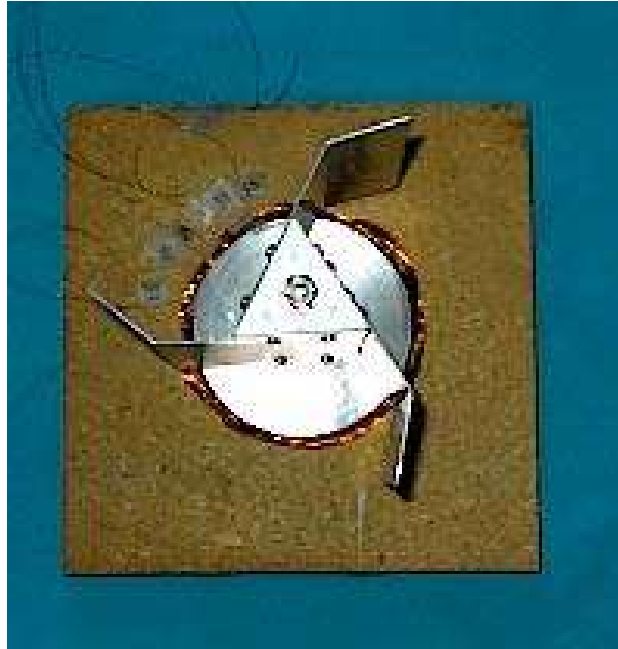

To make the stator a bit more permanent you can coat the wires with a clear enamel. This will help stiffen the loosness of the wires and hold them in place much better. Polyester resin works well also if you have some on hand .

From here we need to wire it up so it can actually do some useful work. There are basically two ways to wire a 3 phase alternator, star and delta. The “star” configuration gives you more volts but less amps and the “delta” gives you less volts but higher amps. I will show you how to wire it both ways but for the instructional model I will wire it in star.

The connections of the wires for star configuration are:

1S – 2E – 3S are output wires  
1E – 2S – 3E are all connected together

The connections of the wires for delta configuration are:

1S to 3E

2E to 1E  
3S to 2S  
each of the three pairs are output leads.

Below is a diagram of star and delta configurations...

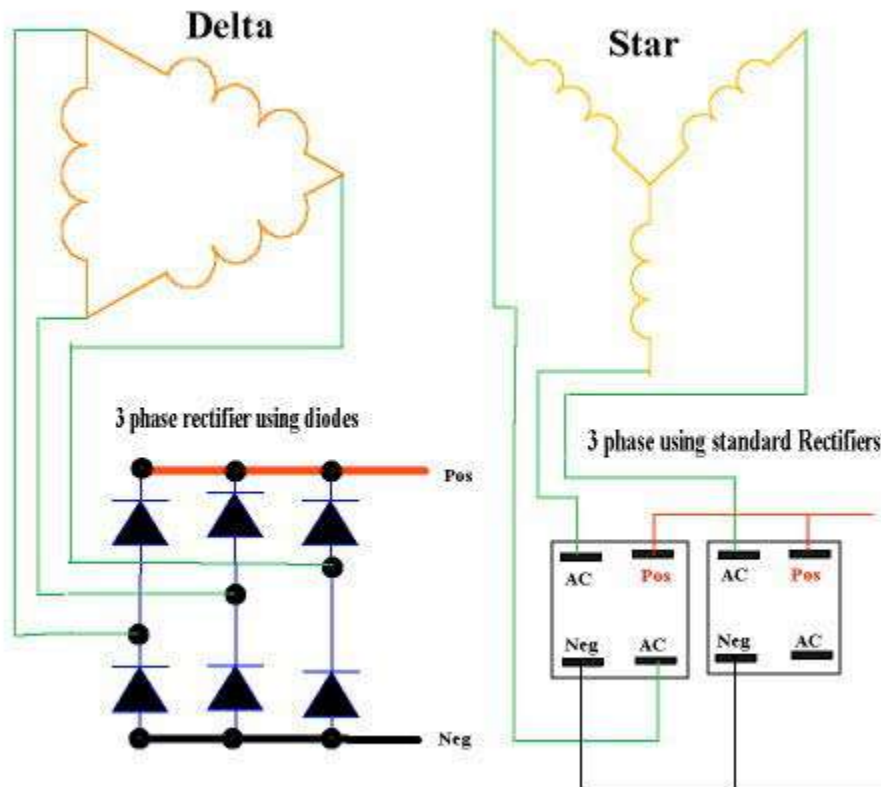

We will be using diodes to rectify the AC voltage coming from the alternator to DC voltage. Shown above in the delta configuration. You can use standard rectifiers shown above in the star configuration but with the power this unit makes the diodes are sufficient.

Since the output of the alternator is in the form of AC (alternating current) its not storable. To make it storable we convert it to DC (direct current). In order to do this we will use standard diodes to make a rectifier. Notice the band around the diode, it is on the end in which the direction the voltage/current will flow. You can connect the diodes together by soldering the ends or simply twisting them together. I have twisted the sets together for simplicity but soldering them makes a nicer looking end product. Below shows the pairs of diodes twisted together...



The picture isn't very clear but if you look closely each of the pairs are going in the same direction. That is to say the band shows the flow from left to right. The twisted portions shown here will be the AC inputs.

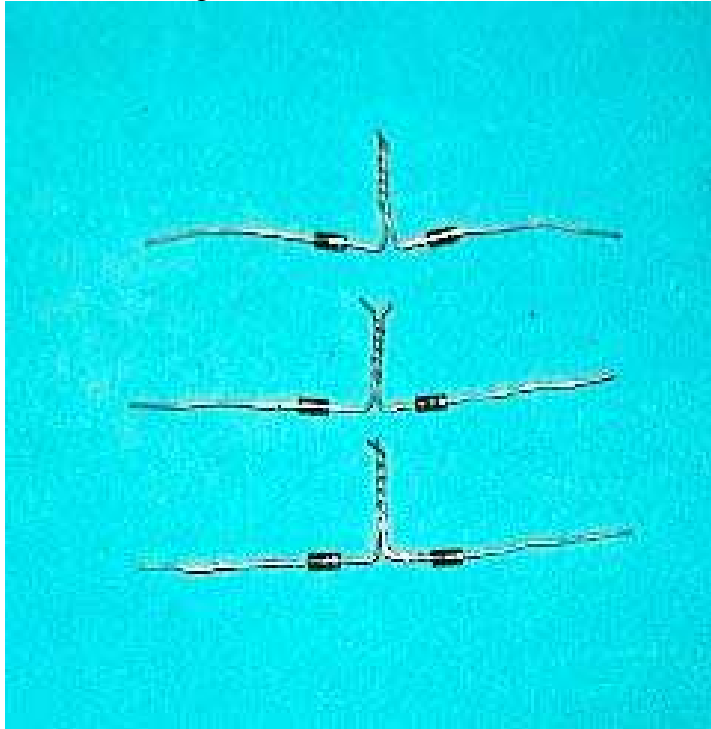

The next picture shows the ends of the 3 pairs twisted together forming the pos (+) and the neg (-) sides of the diodes. These are the ends that will connect to a battery for charging or become the outputs for powering an LED light or other. You can purchase a battery holder and NiCad batteries from Radio shack and wire it to the rectifier. Below shows the diode rectifier twisted together to form the rectifier (left) and input and output of the assembly ( right)...

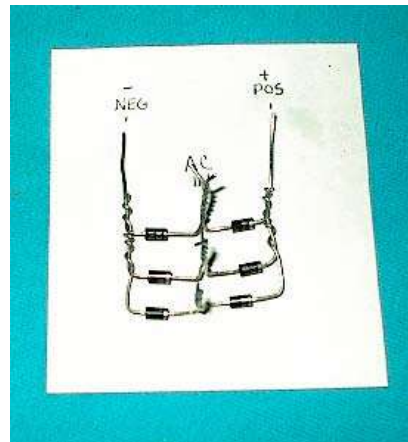
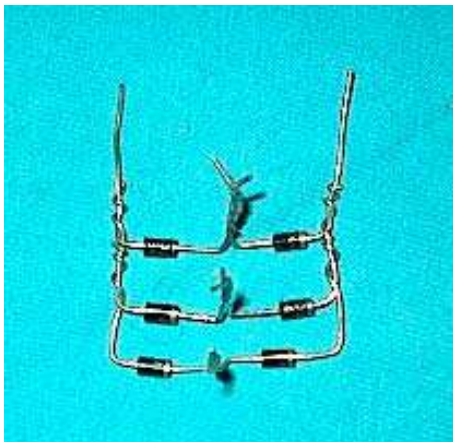

To complete your system you can install a Zenier diode of 3 volts and an led to make a simple shunt regulator. When the batteries reach 3 volts the light comes on telling you the batteries are charged and burns off the extra voltage. If the wind stops and the

batteries are not being charged anymore the light will burn off any excess in the batteries. When the voltage drops to just below 3 volts the light will go out leaving the batteries at a full charge. The simple shunt diagram is shown below...

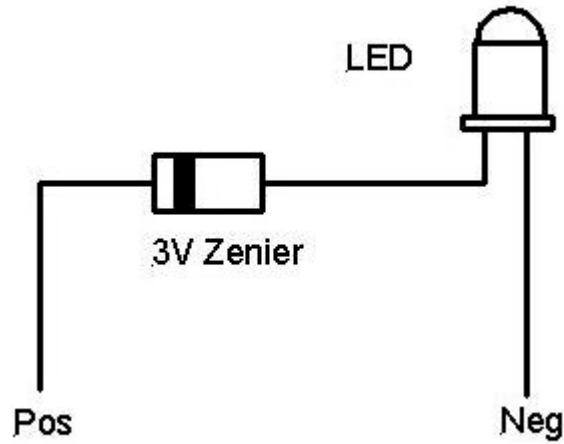

Below is the alternator wiring diagrams for both “star” and “delta” configurations ...

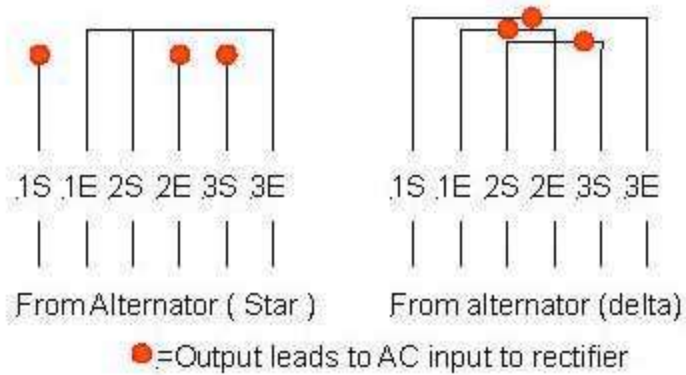

Now you have a completed RE (Renewable energy) system. Experiment and have some fun !!!

# OTHERPOWER.COM

The **CUTTING EDGE** of Low Technology



[Otherpower.com's latest project. 3kW+ output, 48VDC, 17-foot diameter wind turbine built from scratch.](#) Low winds don't have much power available in them. The only way to harvest a useful amount of energy from low winds is to sweep a large area with the wind generator blades. This turbine charges a 48V battery bank in 5 MPH winds, is making 400 Watts at 10 MPH, and 1500 Watts in a 16 MPH wind. This photo shows it fully furlled, producing maximum power of 3800 Watts. The tail folds up and in during high winds, yawing the machine at an angle to the wind to reduce the massive, exponential, power input increase from high winds. The machine has survived 60+ MPH winds in operation. You can read about it [HERE](#).

**Thank you for dropping by!**

**We are a group of alternative energy enthusiasts who want to spread the message that**

**It's EASY to make your own power FROM SCRATCH!** Otherpower.com's headquarters is located in a remote part of the Northern Colorado mountains, 15 miles past the nearest power pole or phone line. All of our houses and shops run on only solar, wind, water and generator power...not because we are trying to make some sort of political or environmental statement, but because *these are the only options available*. And we refuse to move to town.

**We could never have made it to our current level of electrification up here without the help of friends, neighbors--and folks we've never met, thanks to the internet. Our goal is to share our information about experimental successes and failures alike, free of charge, with anyone who is interested. We also offer a wide selection of books and hard-to-find alternative energy parts and components on our web Shopping Cart. We hope you find our pages informative, useful and enjoyable!**

## **The Blunt Edge of High Technology**

For all questions about orders, inventory, tracking, shipping, etc. please [E-Mail our Shipping Office](#)

or call us at: 877-944-6247 (toll-free in USA) or (970) 484-7257. Our mailing address is:

Forcefield  
2606 West Vine  
Fort Collins, CO 80521

Also, you can visit our Retail Store at 614 South Mason St., Fort Collins, CO

You can [send DanB and DanF an E-mail HERE](#). However, PLEASE be aware that we receive many more Email requests for free information and advice than we can possibly respond to and still run our business...they come in twice as fast as we can reply. For quicker advice and opinions alternative energy questions from experimenters worldwide, try posting your question to the [Otherpower Discussion Board](#). Please research your question by searching our discussion board and Google before posting or emailing us. If you do Email us, make sure your email has a good subject line -- if the subject is 'blank', says 'hello' or 'how are you' it will never be read - many viruses and spam contain these headers. Please keep your questions *specific* regarding topics we've written about. If you ask 'how do I build a windmill?' or 'how big a system do I need to run my house?' you probably won't get a reply...please do your homework first. If you ask us 'on your Gerbil-powered generator page, how many turns are in each coil and what direction are they wound' we will almost certainly reply promptly. If we dont, please email again and remind us. THANKS for being considerate!

## OUR NEWEST PAGE

### [17 foot diameter 3kW wind turbine built from scratch](#)



This one is BIG, and performs admirably in low winds. Built completely from scratch, and dumps power to electric heaters when the system battery bank fills up. An awesome, heavy, powerful and quiet machine for an off-grid home.

## OUR NEWEST PRODUCT

### [Wedge magnet for alternator projects--1/2 inch thick, powerful NdFeB magnets](#)

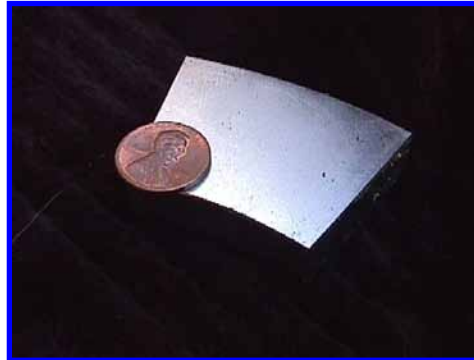

These magnets have a unique shape, and are polarized through the flat faces. The wedge shape means that 16 of these will fit together to form a ring with an 8" inner diameter and an 11" outer diameter. They are 1/2" thick. These could be interesting magnets to use in certain motor and alternator projects.

**[Make Your Power From Scratch!](#)**

**SAFETY NOTE: Some of the experiments described on our pages may present various hazards. Please be cautious. We are not responsible for injury resulting from neglecting safety precautions when performing experiments.**



WWW || Otherpower.com || Otherpower Discussion Board ||  
Wondermagnet.com || Forcefield Shopping Cart

<a href="#">ABOUT FORCEFIELD</a>	<a href="#">PRODUCTS</a>	<a href="#">DISCUSSION BOARD</a>	<a href="#">DAILY NEWS</a>
<a href="#">CONSERVATION</a>	<a href="#">BATTERIES</a>	<a href="#">SUN</a>	<a href="#">WIND</a>
<a href="#">HYDRO</a>	<a href="#">FOSSIL FUELS</a>	<a href="#">EXPERIMENTS</a>	<a href="#">ORDER NOW!</a>
<a href="#">WATER PUMPING</a>	<a href="#">POWER SYSTEMS</a>	<a href="#">EFFICIENT LIGHTING</a>	<a href="#">LINKS</a>

---

©2005 by [FORCEFIELD](#)

**This page last updated 3/17/2005**

---



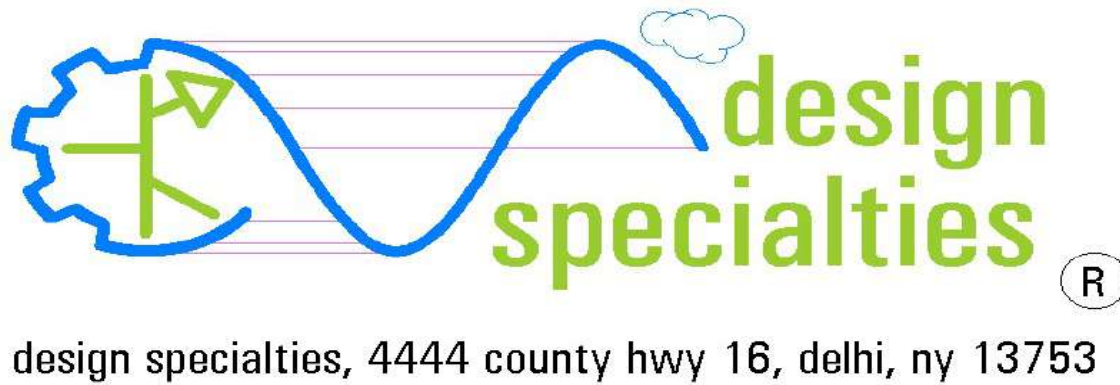

## ...Welcome...

Electronic schematics and mechanical designs for the hobbyist and professional. We also feature programmed microprocessor chips and code along with parts for our designs. Click on the green Products link below to see the chips and accessories we offer.

[Smart Flashlight](#)

[Tach-Plus](#)

[Star Delta Switch](#)

[Remote](#)

[Tach jr. \(also see below\)](#)

[Products](#)

[About Us](#)

[Contact Us](#)

(Due to viruses we no longer open attachments please include you information in the body of your email)



**Due to a family emergency we are not sending out kits temporarily.**

**PLEASE DO NOT paypal us any orders.**

**We will not be able to fill them at this time.**

**As soon as we can resume business we will remove this warning.**

**Thank you for your patience.**

**See my latest article in the Mar/Apr 2004 Home Shop Machinist**

**NEW TACH jr. \$39.95**



## **Tach jr. assembled and tested \$59.95**

(don't forget to order the range extender below if you want it added to your assembled Tach jr. We will build it in for you)

### **What is the Tach jr.?**

**It is a very accurate tachometer that reads rpms directly without any physical contact. It works without any lasers so the user is completely safe from any harmful reflections or rays.**

### **How accurate is it?**

**Very accurate! The main microchip controls the timing and reading. You get the same accuracy from the kit as an individual who buys it completely built and there are NO adjustments to make. Our instruments are up to NIST standards and we pass this on to you.**

### **What is an open architecture?**

**An 'open architecture' means that there is access to the instrument at the component level and modifications are possible. You can for instance, extend the sensors off the circuit board to a remote location or extend the power switch.**

**The Tach jr. is an 'open' instrument. This adds flexibility by allowing the builder to connect it to many different sources. It can work as a Tach for your moped or on a 50,000 rpm CNC machine for instance.**

**The Range Extender (optional) allows it to work from long distances away or tight places and also adds the Hall sensor for magnetic readings. It adds a jack to the**

**Tach jr. circuit board which allows you to have several remote monitors that can simply be plugged into the tachometer whenever that specific instrument needs to be monitored. For instance, you can have a sensor permanently mounted in on your tractor, one on your lathe or robot. Just by plugging in the Tach jr. you can go from one to another in seconds!**

**Several of our customers have done this and it's a great way to obtain multiple applications from just one Tach jr. Again, the key word is flexibility, something you won't find in instruments costing 10 times its low price.**

**Why don't we include a case?**

**Because this is an open instrument and the range of applications are so great we don't include one and pass the savings on to you. Many of our customers built the Tach jr. into their own equipment. Fitting one to a case is an easy job and many of our customers do it themselves with no problems.**

**The only external wiring is to the battery case (included) but the user has the option of leaving the battery case off and using the power jack to a small wall transformer.**

**How hard is it to build?**

**Quite easy. You will need a good soldering iron but aside from that the kit is very straight forward including complete in depth instructions with the novice in mind.**

**What if I get stuck?**

**We monitor the web site everyday and are always here to help although it is rarely needed!**

**All the components and circuit board are the highest quality and we have**

**had  
no instrument failures or returns since the Tach jr. was introduced over two  
years ago.**

## **Tach jr. details and photos**

**Need a Tach for a special application? Email us.  
We can program the main chip to fit your needs.  
We get lots of great mail just like the one below  
from our happy customers.**

**"The jr pcb is awesome. Nicest kit board I've ever built!"**

**Richard, New Hampshire**

**TJ option: Fits on your board and lets you  
run a 50 or more foot wire to the optical sensor or Hall (magnetic)  
sensor. You get all the hard to find parts, one sensor/emitter pair, one  
hall sensor plus the remote jack (J1 on the TJ board) and a 1k resistor.  
(Requires a standard 1/8" stereo phone jack and wire to work. We use  
telephone connection cable and Radio Shack phone plugs.) No circuit  
board is required and wiring is an easy task. (Only works with Tach jr.)**

**ONLY \$6.95**

**The new IR remote (Works with both Tach-Plus and Tach jr.) is now ready**

**Remote**

Projects in the 'works':

Wind speed indicator

Zero expansion pendulum

High precision 4-1/2 digit voltmeter

8 digit low cost frequency counter

CNC mini lathe option for screw cutting

Have an idea about a great project you would like to see? [\*\*Contact Us\*\*](#)

Circuits and circuit boards for the kit builder from people who build kits.

Our latest design is the Tach jr. It is a digital tachometer that reads a reflective aluminum strip off a rotating shaft or propeller. With the new remote the Tach jr. and Plus will be able to read a rotating shaft 50' (15 M) away with the push of a button. Click above for more information.

The Smart Flashlight was conceived during a power failure at our home. It is in daily use here and helps us find auxiliary lights when the main power fails from our rural upstate NY electric co-op. It is also a wonderful teaching project for schools and amateur radio clubs.

Check back for new circuits and projects.

One note about our phone number and credit cards.

We have tried to make the highest quality products at the fairest prices. While very few people have assembly problems we try to resolve them as quickly as possible through emails. The 'contact us' email site is monitored everyday and while we haven't had to use it we will give our telephone number to individuals who can't resolve their kit problem. We just can't monitor phone calls from around the world and still give the quality in our products that we do.

We accept paypal, money orders and personal checks for now. As our business grows we hope to accept credit cards also.

Please contact us if you have any questions or concerns.

Thank you,  
Robert Nance Dee

Design Specialties  
4444 County Hwy. 16  
Delhi, New York 13753

## LINKS TO MY FAVORITE SITES

**[Otherpower Alternate Energy](#)**

**[Windstuff](#)**

**[The Remote Control Store](#)**



# Wind Charts



Here are some wind charts to get an idea of how the wind is in your area.



**CLASSES OF WIND POWER DENSITY**

WIND POWER CLASS	10m (33 ft)			50m (164 ft)		
	WIND POWER W/m <sup>2</sup>	SPEED m/s	mph	WIND POWER W/m <sup>2</sup>	SPEED m/s	mph
1	0	0	0	0	0	0
2	100	4.4	9.8	200	5.6	12.5
3	150	5.1	11.3	300	6.4	14.3
4	200	5.6	12.5	400	7.0	15.7
5	250	6.0	13.4	500	7.6	16.8
6	300	6.4	14.3	600	8.0	17.9
7	400	7.0	15.7	800	8.8	19.7
	1000	9.4	21.1	2000	11.9	26.4

 RIDGE CREST ESTIMATES (LOCAL RELIEF > 1000 FT)

# WINTER

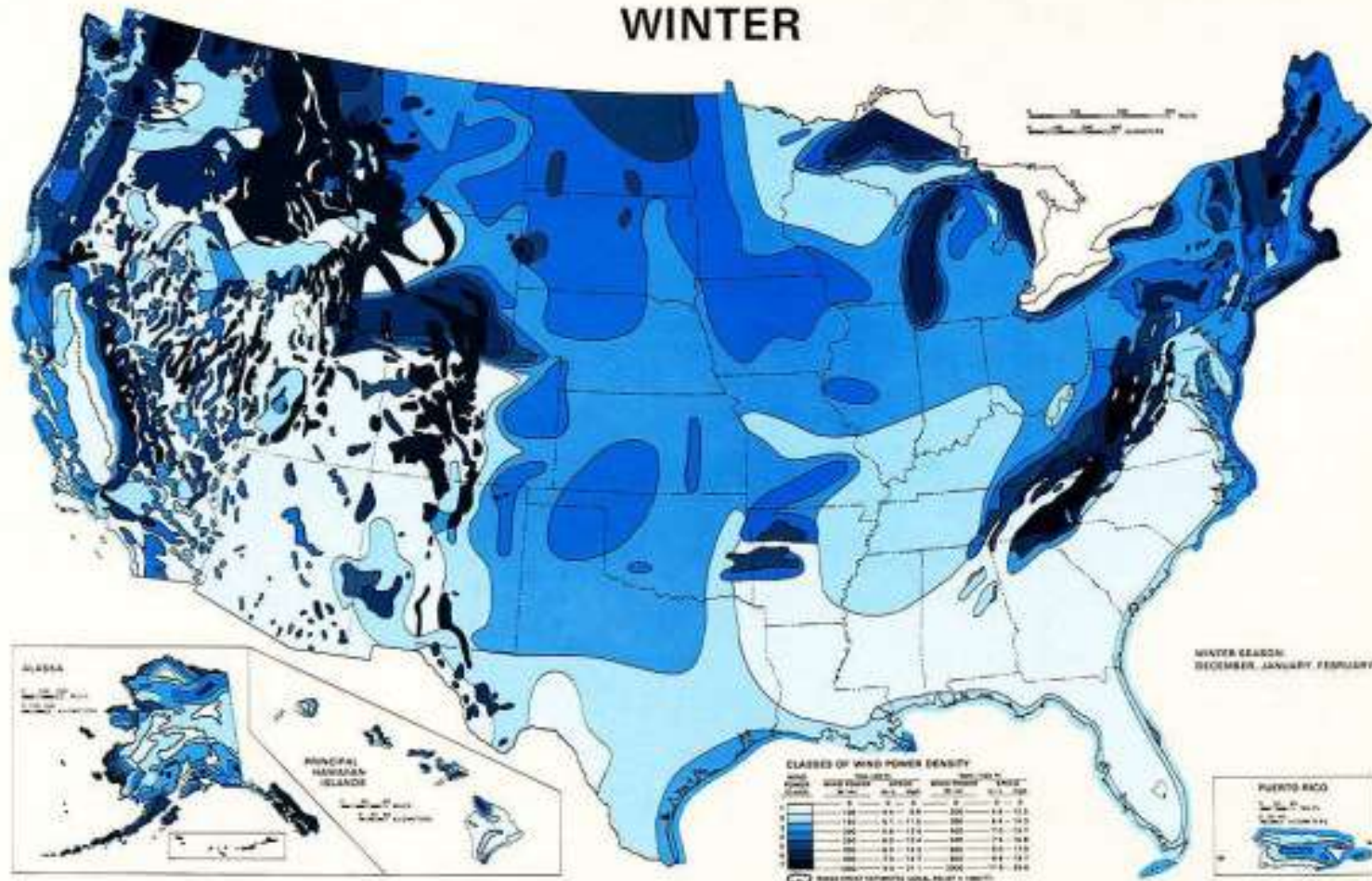



# SPRING

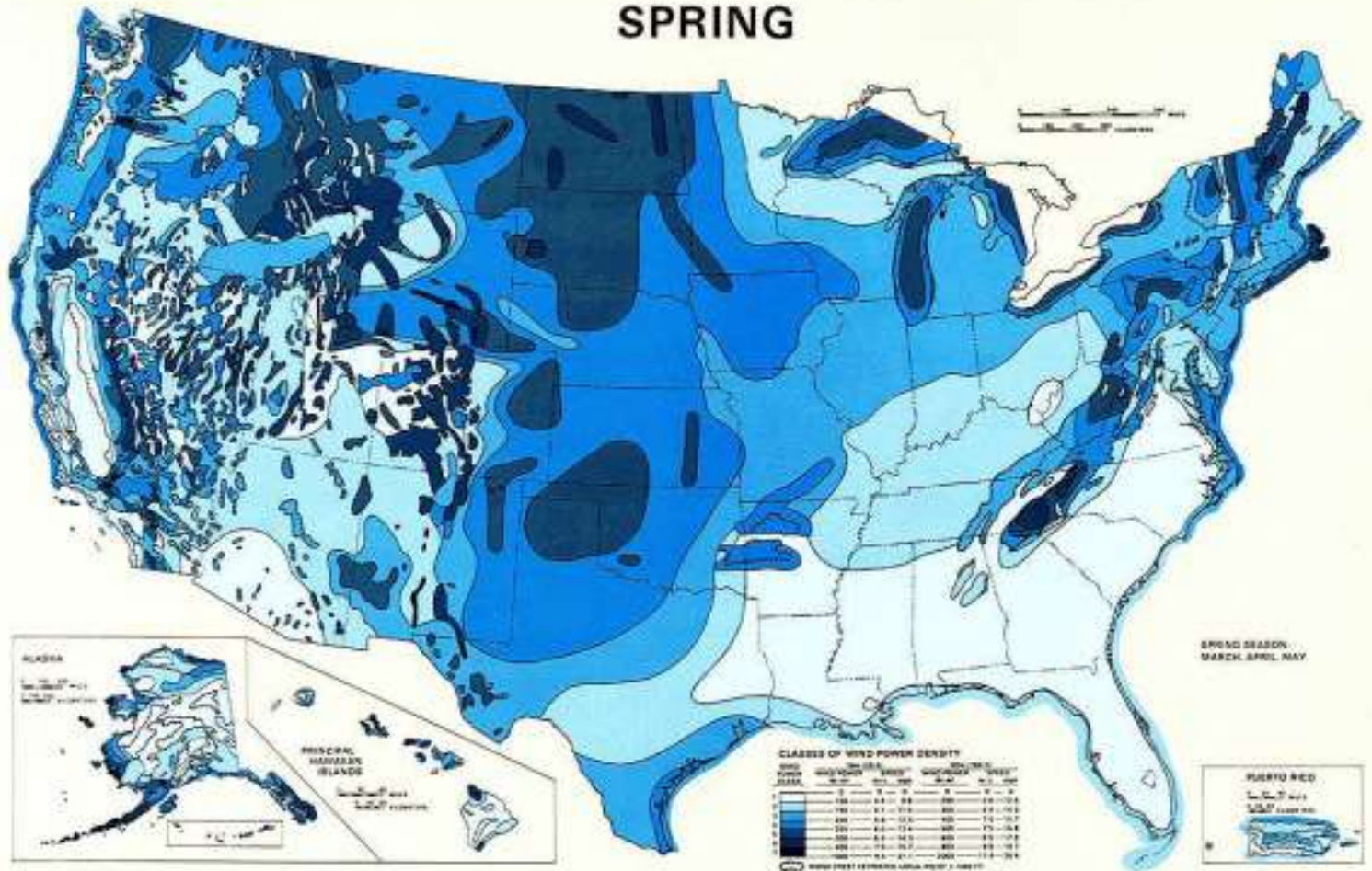

# SUMMER

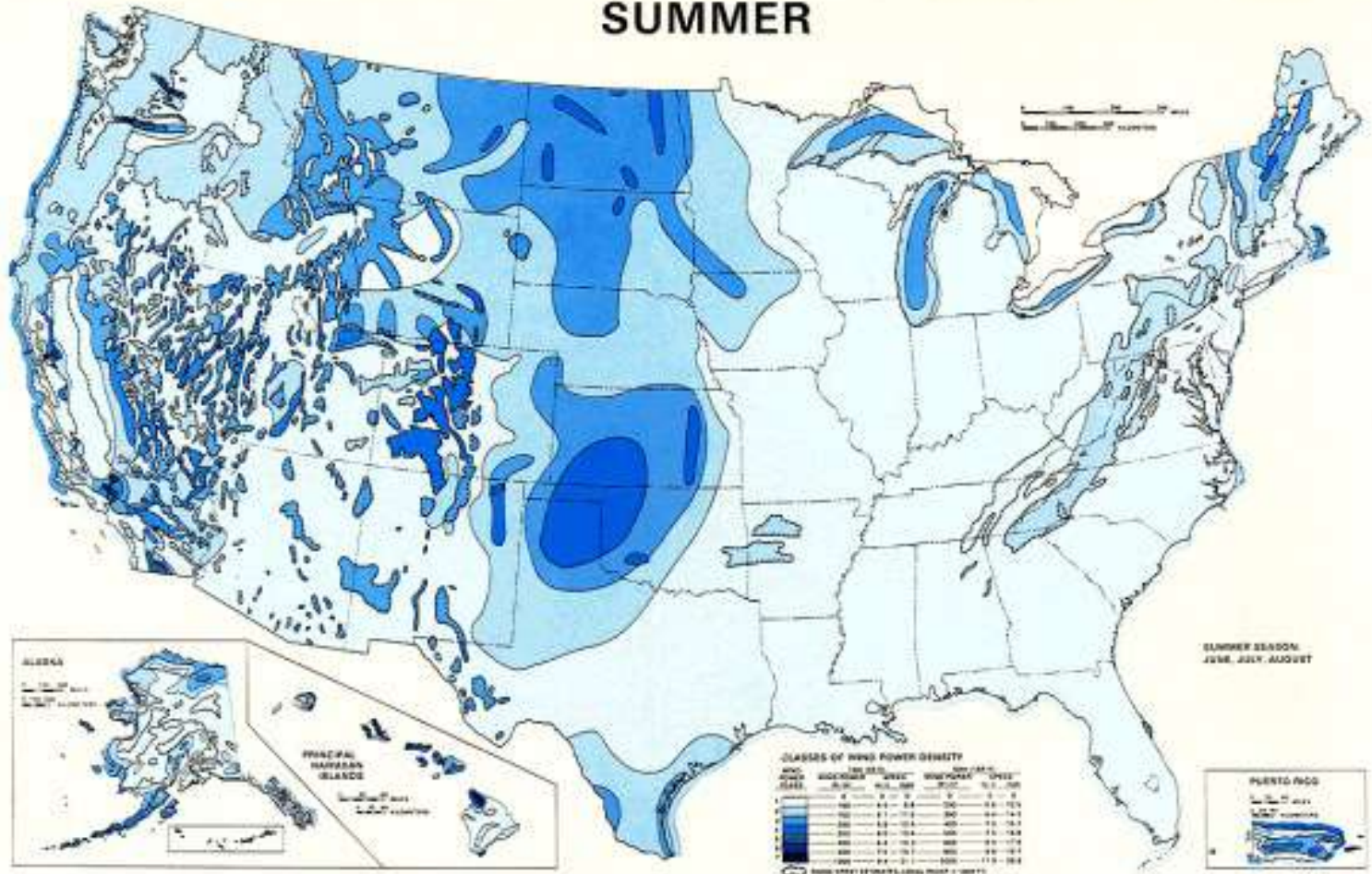

# AUTUMN

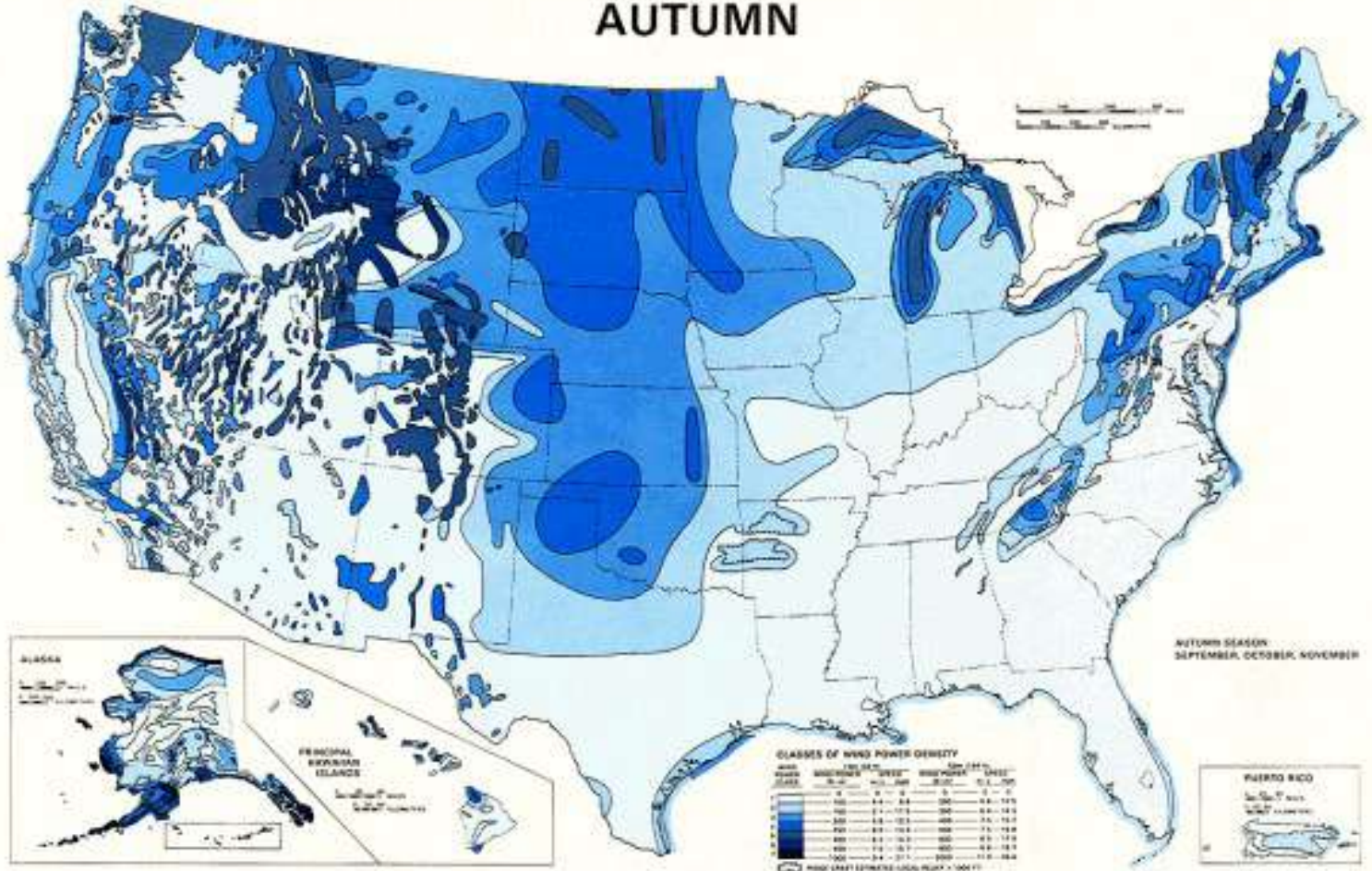



**Web** [Images](#) [Groups](#) [News](#) [Froogle](#) [Local](#)<sup>New!</sup> [more »](#)

[Advanced Search](#)  
[Preferences](#)  
[Language Tools](#)

[Advertising Programs](#) - [Business Solutions](#) - [About Google](#)

©2005 Google

# Basic BLADE DESIGN

by Claus Nybroe  
Windmission

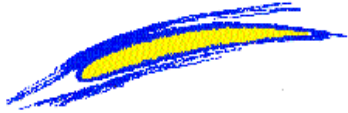

## CONTENTS:

- [1. INPUT DATA](#)
- [2. VELOCITIES IN THE ROTOR PLANE](#)
- [3. TIP SPEED RATIO](#)
- [4. MATCHING FORMULAS](#)
- [5. SELECTING BLADE CHORD AND PROFILE](#)
- [6. ANGLES](#)

With this rather simple method we over the years have made very efficient blades ( $C_p$ -max measured = 0.46). Do not be afraid of the mathematics. There are only 6 formulas and a couple of curves. All Calculations can be performed by hand or by the means of a pocket calculator, a spreadsheet or another small computer programme.

The paper is made as an example based on known generator data from Ian Cummings, Putnam CT.

In Ian's case we start with known generator data. Alternatively you can also start with known wind, rotor or profile data. The formulas are all there.

## 1. INPUT DATA



Troels from Risoe climbing a 2.2 kW Windflower prototype.  
1987

The metric (m) system is used.

1000 meter = 0.625 US miles

Power is measured in Watts (W)

1 HP = 736 W

Ian Cummings has provided us with these approximate data:

PM-generator.

220 W at 700 rpm (revolutions per minute)

2 bladed rotor

## 2. VELOCITIES IN THE ROTOR PLANE

To get a first grip of things please have a look at [the velocities in the rotor plane](#)

## 3. TIP SPEED RATIO

We start by selecting a value for the Tip Speed Ratio (TSR) which is defined as

(Formula 1) :

TIP SPEED RATIO (TSR) =

(tip speed of blade)/(wind speed).

The tip speed ratio is a very important factor in the different formulas of blade design.

Generally can be said, that slow running multi bladed wind turbine rotors operate with tip speed ratios like 1-4, while fast runners use 5-7 as tip speed ratios.

Ian Cummings wants to cut a two bladed rotor. This rotor type usually runs very fast, so let's choose a tip speed ratio of 7.

## 4. MATCHING FORMULAS

The task is now to fit the known generator capacity and revolutions to the wind speed and to the swept rotor area. Two formulas are needed:

(Formula 2) :

Power (W) = 0.6 x Cp x N x A x V<sup>3</sup>

(Formula 3):

$$\text{Revolutions (rpm)} = V \times \text{TSR} \times 60 / (6.28 \times R)$$

Cp = Rotor efficiency

N = Efficiency of driven machinery

A = Swept rotor area (m<sup>2</sup>)

V = Wind speed (m/s)

TSR = Tip Speed Ratio

R = Radius of rotor

Rotor efficiency can go as high as Cp = 0.48, but Cp = 0.4 is often used in this type of calculations.

This concept works without transmission. If a transmission with an efficiency of 0.95 was to be included this means that

$$N = 0.95 \times 0.7$$

In Ian Cummings case the following values fit into formula (2) and (3):

Tip speed ratio "TSR" = 7"

Wind speed "V" = 8.6 m/s

Rotor efficiency "Cp" = 0.4

Generator efficiency "N" = 0.7

Swept rotor area "A" = 2.11 M<sup>2</sup>

Radius of rotor = 0.82 m

Revolutions = 701 rpm

Power output = 226 W

It took about 20 minutes to perform these calculations and make them match on the pocket calculator. A simple spreadsheet can also be useful.

## 5. SELECTING BLADE CHORD AND PROFILE

The width of the blade is also called the blade chord. A good formula for computing this is:

(Formula 4):

$$\text{Blade Chord (m)} = 5.6 \times R^2 / (i \times Cl \times r \times \text{TSR} \times \text{TSR})$$

R = Radius at tip

$r$  = radius at point of computation

$i$  = number of blades

$C_l$  = Lift coefficient

TSR = Tip Speed Ratio

As can be seen from formula (4) we need to know the lift coefficient " $C_l$ " in order to compute the blade cord. This means that we have to select a profile. A lot of good profile data can be found in model airplane (gliders) literature.

We have chosen the [NACA 2412 profile](#)

The side facing the wind is flat, which makes the profile easy to construct. It is an effective profile with a good thickness, which makes the blade strong.

In order to determine the lift coefficient we must have a look at the [profile curves](#).

By checking the NACA 2412 profile curves  $C_l$  is determined to be 0,85. Ian Cummings formula now looks like this:

"Chord" =  $5.6 \times 0.82 \times 0.82 / (2 \times 0.85 \times 0.82 \times 7 \times 7)$  (m)  
Tip

"Chord " = 55 mm  
Tip

Now, calculate blade chord at  $2/3 \times R$ . On a paper choose a center line at at distance  $1/3$  from the leading edge. Connect the the two blade chords, and you can measure all the cords of the blade. ([Illustration](#))

The closer you come to the hub you might choose thicker profile to increase strength. Close to the hub you should also consider an extra increase in chord in order to make the blade start easier.

## 6. ANGLES

Have a look at the [angles of the blade](#) where the angles for Ian Cummings are calculated.



Close to the hub you should consider an extra increase in the angle of attack, in order to make the blade start easier.



[Home](#) [PMG's](#) [Windflowers](#) [Projects](#)  
[Workshop](#) [Crew](#) [Contact](#)



## WELCOME

Windmission is a small Danish family owned company. Over the years specialized in turbines equipped with Windflower rotors, quiet multi bladed super wind roses with a high efficiency.

A fire in 2000 stopped selling wind turbines, and at present Windmission has transformed into a R&D company with focus on developing new 0.4 - 1.5 kW Windflowers, general consulting and PMG distribution.

# Scoraig Wind Electric



Hugh Piggott's Homepage  
updated October 2005

[Older stuff on this site](#)

[hugh@scoraigwind.co.uk](mailto:hugh@scoraigwind.co.uk)

## 'How to Build a Wind Turbine' "the axial flux plans"

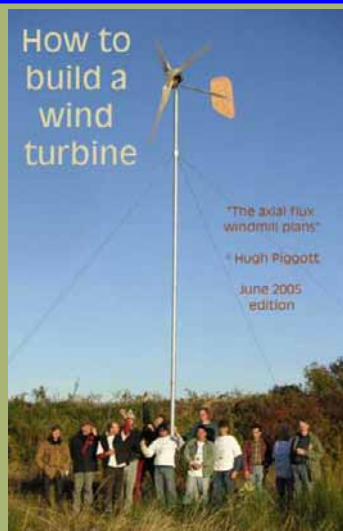

I recently purchased your June 2005 edition of "How to build a wind turbine". It arrived just last week and I read through it from cover to cover that very day. You are to be congratulated for the amount of detail, hints and information this manual contains. I can certainly understand the amount of work (and tears), to put this sort of information into a manual. One of the best 'how to' books I've ever read (and I

have a few).

Mark Atkins

Swansea Tasmania Australia

[NEW COLOUR EDITION](#)  
[WITH DETAILS OF 10' AND 12' DIAMETER MACHINES](#)

*"i read it thoroughly.wonderful book.crystal clear."*

### TRANSLATIONS

(BUY DIRECT FROM THESE 2 LINKS)

[FR Comment construire Une Eolienne](#)

[IT Come costruire un generatore eolico](#)



[Windmill building workshop courses page](#)

Lots of stories and pictures.

## CONTACT

Email me at:

[hugh@scoraigwind.co.uk](mailto:hugh@scoraigwind.co.uk)

Or (if you must) send snail mail to:  
Scoraig Wind Electric,  
Dundonnell,  
Ross shire, IV23 2RE, UK

Mobile 077 1315 7600

I respond much quicker to **e-mail** than to letters!

I do reply to all reasonable e-mail questions.

Letters often get no reply.

### (SPAM SETTINGS

Please make sure your spam settings **allow me to reply** to your question!! It is very frustrating to spend maybe 20 minutes writing a helpful reply and then to find that I cannot even contact you because you have such paranoid spam settings.)

[Get my Books here](#)



[SUPPLIERS OF PARTS](#)  
[BLADES](#)  
[WHOLE MACHINES](#)



[Course at Four Winds Inspiration Centre](#)  
[March 2005](#)



[bluEnergy doing it in nicaragua with room for help](#)

## Links and addresses

To people around the world who are building axial flux wind turbines using my design.



[Discussion board with loads of homebrew wind projects and more. An ongoing source of inspiration. New messages with pictures every day.](#)

## Craig and Connie Cook

in southern Ontario  
[www.windchasers.ca](http://www.windchasers.ca)

We are hoping to make this into a kind of turbine co-op where everyone who comes to put one together comes

[Homebuilt windpower site in the](#)



[UK](#)

<http://www.otherpower.co.uk/>

## Mark Pitterle builds an axial flux wind turbine in India



[Our current project is to design, develop, and implement sustainable energy systems for the villagers of the Narmada river valley in India.](#)



[A photograph of the new HAWT built in India in the Spring of 2005! Team members Mark Pitterle and Rachel Werther worked alongside the villagers of the Mozda Collective to raise the first wind turbine in the Narmada River Valley. Field performance data is now being gathered.](#)

## Wind turbine construction at University of Dschang. Cameroon, Africa.

back

with the knowledge that they have gained to help other people to put one together. We have a dedicated bunch who get together almost every week at our house to work on their turbines.

The atmosphere is fun and very enthusiastic! **Everyone helps everyone else.** Some are farther along than others, so they help to guide the newcomers.



Craig smiling for Mike as he stands beside his stator on our little test tower by our house. Good Shot Mike!

## Axial flux windmill plans now also available [in French!](#)



[French homebrew site - en Francais](#)

## [Homebrew flux-meter device information](#)

[www.windstuffnow.com](http://www.windstuffnow.com)

interesting axial alternator



Before Scoraig 2003



After Scoraig 2003

the Scoraig-built turbine has finally got to Cameroon.....

[Julius Kewir Tangka goes to customs in Douala to fetch the turbine we built in 2003 \(a story\).](#)

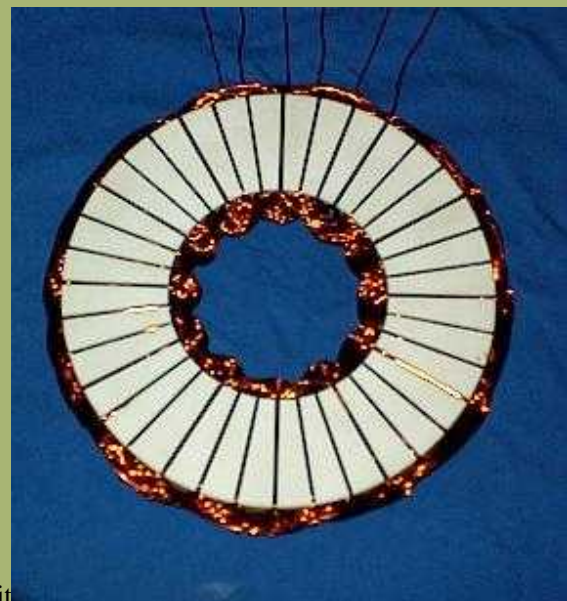

kit

[Axial flux windmill plans now available in Italian](#)

## [Come costruire un generatore eolico](#)

[TRADUZIONE ITALIANA](#)  
[di Antonio Cecere e Beatrice Paparella](#)

## [Turning Wind Turbines in Ghana](#)

EnterpriseWorks/VITA's wind energy project in Ghana was recently featured in African Energy Journal, a journal reporting on the African continent's fast-developing power infrastructure, with an emphasis on providing early notification of emerging projects. The article is reprinted with permission.

**Quick links to older stuff on this site**

[Homebuilt windpower - general information](#)  
Mostly rather dated but useful

[Blade theory](#)

[Blade carving - diagrams](#)

[Blade carving - colour pics](#)

[Power performance testing of small wind turbines](#)

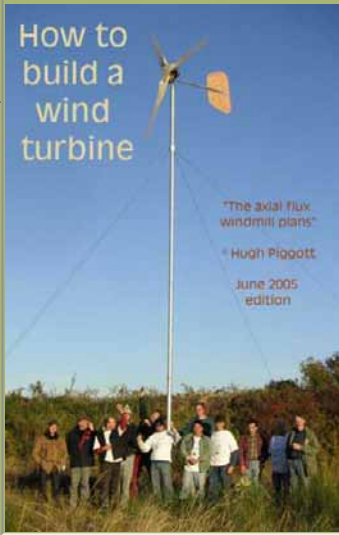
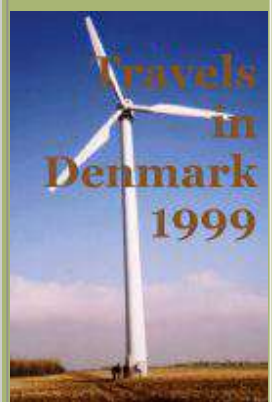
<p><a href="#">Free downloadable pdf files</a> for blade manufacture and other aspects of small wind/battery systems</p>	<p><a href="#">Permanent magnet alternator construction manual - free download in acrobat pdf</a></p>	<p><a href="#">Using a servomotor as a pm generator</a></p>	<p><a href="#">Notes for brakedrum builders - extra information to supplement my plans</a></p>	<p><a href="#">Differences between the 'European' and the 'North American' versions of the brakedrum design</a></p>	<p><a href="#">Magnet suppliers</a></p>
<p><a href="#">Technical stuff about load control circuits</a></p>	<p><a href="#">Current in 3-phase cables</a></p>	<p><a href="#">Performance and noise curves for <b>the AirX turbine</b> from Paul Gipe's personal research program are now available here.</a></p>	<p><a href="#">Power performance testing of small wind turbines</a></p>	<p><a href="#">Blade design spreadsheet</a></p>	<p><a href="#">Free downloadable pdf files</a> for blade manufacture and other aspects of small wind/battery systems.</p>
<p><a href="#">Renewable energy options for electricity supply on the Isle of Eigg</a></p> <p>A report on the potential for small hydro, wind and photovoltaic systems on the island</p>	<p><b>pmg construction manual is now available for free download IN DANISH (på Dansk)</b></p>	<p><a href="#">Scoraig where I live : Our house</a></p>	<p><a href="#">Tour of the Scoraig wind turbines in year 2000</a></p>	<p><a href="#">More information about Hugh (rather dated needs revising:-)</a></p>	<p><b><a href="#">'How to Build a Wind Turbine' "the axial flux plans"</a></b></p>  <p>How to build a wind turbine</p> <p>"The axial flux windmill plans"</p> <p>© Hugh Piggott</p> <p>June 2005 edition</p>
	<p>Information about African Windpower and the <a href="#">AWP36 wind turbine</a>, some pics and its history</p>				

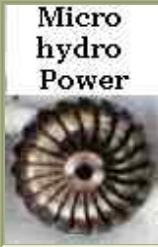
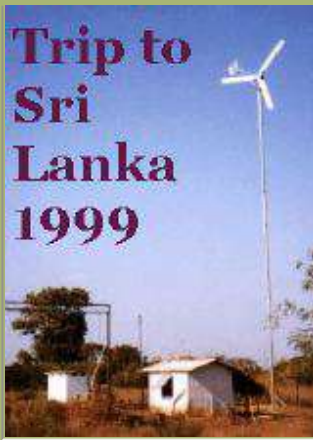
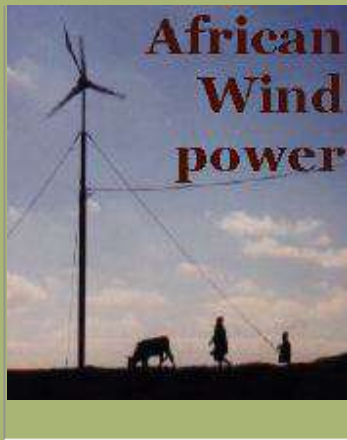

# SUPPLIERS OF MATERIALS FOR HOMEBREW MACHINES

# FORCEFIELD

Magnet suppliers worldwide - based in Colorado - great discussion



board.

[2" x 1" x .5" magnets blocks for \\$6.50 each in quantity](#)

## Magnet plates in the UK

from [Andy Taylor](#)

Price of 8mm thick disc is £14.00 each  
The 6mm discs for the free download pmg at £6.00 each.

Unfortunately the 8mm discs cost a lot more to be cut out.

18 Tilleycombe Road,  
Portland  
Dorset



[CMS Magnetics Co.](#)

[Reliable Source of Permanent Magnets](#)

## [Magnet suppliers in the UK](#)

Sell neodymium magnets suitable for use in the axial plans for £3.95 each.



DT5 1LG  
Telephone number 01305 861001  
Mobile number 07818656345  
E-Mail windhover500@aol.com

Murray J Stewart  
Finance Manager  
**E-Teq (Scotland) Limited**

Unit 3A  
Edingham Industrial Estate  
Dalbeattie  
Dumfries & Galloway  
DG5 4NA

tel 01556 612128  
fax 01556 612537  
mobile 07900 926052  
[murray@murr.co.uk](mailto:murray@murr.co.uk)



Magnet suppliers in Australia

stock the 2" x 1" x 1/2" magnets for the axial flux design.



**Magnet supplier in CANADA**  
**TROPICAL SUN TRADING**

Email : [nrag1662@rogers.com](mailto:nrag1662@rogers.com)  
Mobile: 416 709 9466



Worldwide Supplier of magnets  
of any type or shapes for axial  
flux wind turbines or motor  
conversions.



Copper winding wire in the UK:

**EC WIRE LTD** (01924) 266 377

[sales@ecwire.co.uk](mailto:sales@ecwire.co.uk)  
<http://www.ecwire.co.uk/>

Moulded plastic blades

suitable for dual rotor axial flux machines  
from Art Randolph in eastern USA



navitron

affordable alternative energy solutions  
Importing chinese technology into the UK



[Claus Nybroe at windmission, the small-wind guru of Denmark, with exciting alternators for self-build](#)



[Ampair wind and water turbines are about as near to 'fit and forget' as you can get!](#)



[Proven make really substantial](#)

[wind machines, for rough weather and the long haul.](#)

A site with both windmills and woolly bits!

[Clive \(DCW\) Wilkinson](#)

[PowerSense](#)

[Dunnose Head Farm](#)

[Falkland Islands](#)



[Wind and Sun are a UK company that specialises in grid connected wind, solar, and other applications which use inverters.](#)

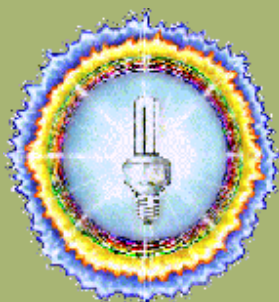
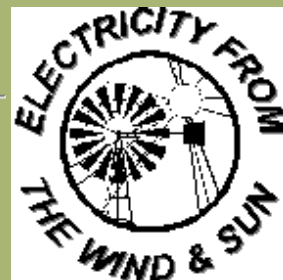

[Home Power magazine is the Hands-on Journal of Home-Made Power.](#)

A shop window of small scale renewable energy in the USA, with some 'homebrew' stuff too.

[Picoturbine .](#)

"We provide plans, books, videos, and kits for renewable energy education and homebrew projects. Projects are available for fifth grade through adult at this time."





is George Glaister's site for **electric-powered mopeds**.

[www.electrichorse.co.uk](http://www.electrichorse.co.uk)



E-mail me at: [hugh@scoraigwind.co.uk](mailto:hugh@scoraigwind.co.uk)

# Waste Oil Burner Project

| [Home](#) | [Pics](#) | [Atomizer](#) | [Updates](#) |

I have had some interest in this waste oil burner stove I made to heat water which can be used for many purposes. Its design is very simple, I started with the leftover shell from a 60 gal Electric hot water tank that i cut a section from to make a snow plow blade for my riding lawn tractor ([see pics](#)), The tank had a concave bottom so while cutting the shell it was flipped around and welded back on. The opposite end was also removed to shorten the shell to a more manageable size. A chimney hole was cut in and a short stack with a 6" dia was welded on for an exhaust and a small fitting to fit the nozzle through was welded in place. When the Front bell was off I cut a door into it and added some rudimentary hinges and some spacers to the existing holes for a fresh air source.

The shell the had some anchors welded inside the circumference to it to help retain the refractory material, then was lined with ceramic cloth to allow for expansion and contraction of the refractory and shell from the hot/cold cycles. The refractory was obtained from a local boiler repair shop and unfortunately is one of the more expensive aspects of this project but was a necessity as i wanted to be able to have this stove indoors and not have a shell temp of 1800°+ F to burn one self on.. Before lining the shell with refractory i cut a couple of holes for the necessary plumbing and a form was made for the inside diameter to retain the refractory. I had to cut some cheap laminate material to go between the anchors to cover the ceramic cloth insulation from completely collapsing while tamping

in the refractory.

Tamping in the refractory was an adventure all in itself, but once done it looked pretty sharp. If you choose to duplicate my efforts you should consult the supplier for specific instruction on how to apply the refractory as different brands will have different instructions.

After the refractory was set and heated up a bit to cure I fitted the inside of the tank with 50 feet of 1/2" copper tubing (the length of which I have determined is not enough) and plumbed the ends to the outside of the shell.

I am still deciding on how much storage water to use, I have another 50 gal hot water tank that had rusted a pinhole out and I braised it up, Brass is more than adequate as I don't intend to run any pressure beyond 20 psi if I decide to seal the system.

For circulation i am running a 1/25 HP Taco radiant heating circulation pump, so far with only the 50 ft of copper its more than enough, as a matter of fact to regulate the temps I have a gate valve before the stove to slow the flow down so its got time to pickup the heat. Hence the determination of not enough copper tube.

The nozzle and associated hardware I'll explain in more detail on the [Atomizer](#) page (sounds so high tech doesn't it?)

And at the request of a friend that I put a picture of a naked chick on my page.. Here it is!



naked chick

# AIRHEADS

---

comments by dave

I feel that the pictures and info on this page are mostly due to a dedicated commitment by Jerry, to find the best solutions possible for alternative power, using as many easily found and affordable parts as possible.

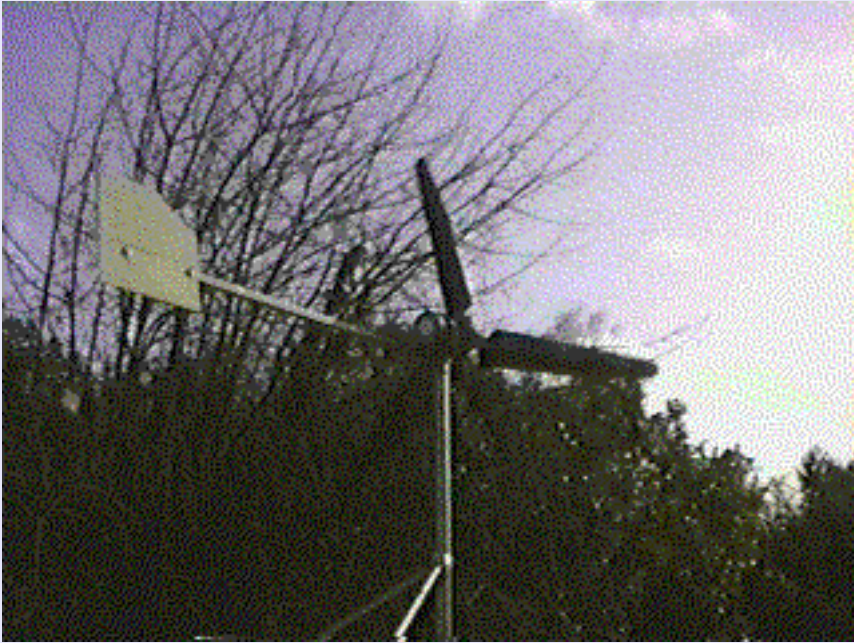

new gen-reinforced Jerry blades-Mike mods-tape drive motor-(have high hopes)

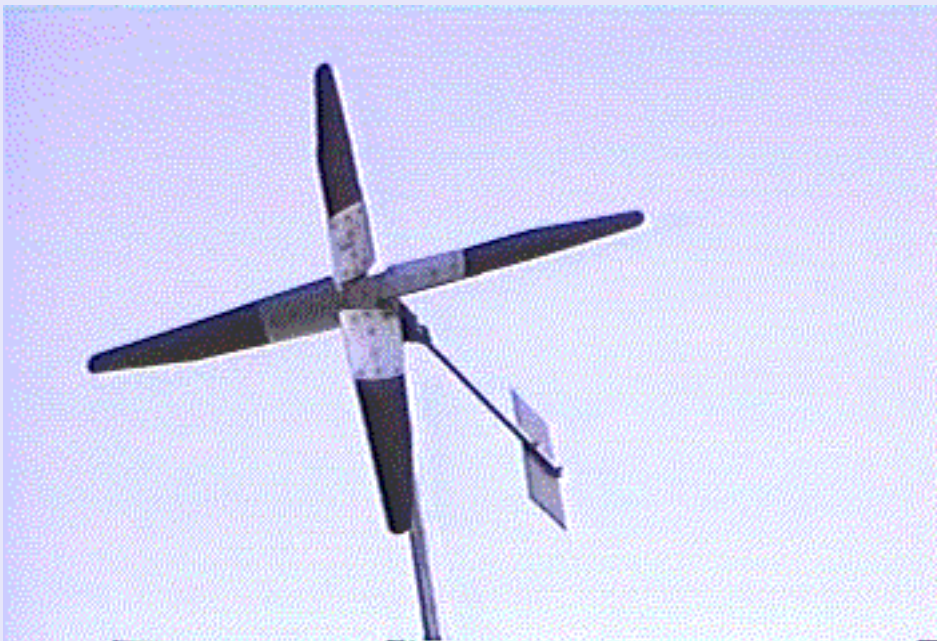

newest gen-reinforced Jerry blades-Mike

mods-tape drive motor-my extended reinforcements(5ft diameter)



To read some comments & info left by Jerry Click [this](#)



[Click on this to E-MAIL JERRY](#)



[Click here for OTHERPOWER](#)

Click on a picture to see the larger version









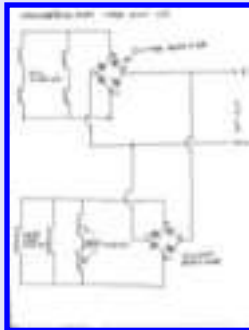





These are mine



